



RIGOL

PIA1000 Series

Optical-fiber Isolated Probe

User Guide

Nov. 2025



Guaranty and Declaration

Copyright

© 2025 RIGOL TECHNOLOGIES CO., LTD. All Rights Reserved.

Trademark Information

RIGOL® is the trademark of RIGOL TECHNOLOGIES CO., LTD.

Notices

- RIGOL products are covered by P.R.C. and foreign patents, issued and pending.
- RIGOL reserves the right to modify or change parts of or all the specifications and pricing policies at the company's sole decision.
- Information in this publication replaces all previously released materials.
- Information in this publication is subject to change without notice.
- RIGOL shall not be liable for either incidental or consequential losses in connection with the furnishing, use, or performance of this manual, as well as any information contained.
- Any part of this document is forbidden to be copied, photocopied, or rearranged without prior written approval of RIGOL.

Product Certification

RIGOL guarantees that this product conforms to the national and industrial standards in China as well as the ISO9001:2015 standard and the ISO14001:2015 standard. Other international standard conformance certifications are in progress.

Contact Us

If you have any problem or requirement when using our products or this manual, please contact RIGOL.

E-mail: service@rigol.com

Website: <http://www.rigol.com>

Section	Description	Page
	List of Figures.....	ii
1	Safety Requirement	1
1.1	General Safety Summary	1
1.2	Maintenance Safety Summary	2
1.3	Safety Notices and Symbols	2
1.4	Working Environment	3
1.5	Environmental Considerations	4
2	Document Overview	6
3	General Inspection	7
4	Product Overview	8
4.1	Introduction	8
4.2	Probe Size	9
4.3	Electrical-Optical Converter	10
4.4	Optical-Electrical Converter	10
4.5	Probe Controller	10
4.6	Attenuating Tip	12
5	To Use the Probe	13
5.1	Precautions and Safety Requirements	13
5.2	To Install and Remove the Attenuating Tip	14
5.3	Measurement Steps	15
5.4	To Calibrate the Probe	16
6	Specifications	18
7	Maintenance	23
7.1	Troubleshooting	23
7.2	Care and Cleaning	24
8	Appendix	25
8.1	Appendix A: Order Information	25
8.2	Appendix B: Warranty	26

List of Figures

Figure 4.1 PIA1000 Series Optical-fiber Isolated Probe	8
Figure 4.2 Probe Size	9
Figure 4.3 Electrical-Optical Converter	10
Figure 4.4 Optical-Electrical Converter	10
Figure 4.5 Probe Controller	11
Figure 4.6 Attenuating Tip	12

1 Safety Requirement

1.1 General Safety Summary

Please read the following safety precautions to avoid personal injury and to prevent damage to this product or any equipment connected to this product.

To prevent possible hazards, be sure to use this product in accordance with the regulations.

The product can only be used by personnel with relevant technical training.

Connect or Disconnect the Equipment Properly.

- Only use the testing wires and accessories that are provided with the product or specified by RIGOL.
- Connect the probe output terminal to the oscilloscope before the probe is connected to the circuit under test.
- Keep a safe distance from the E-O converter and the attenuator when connecting to the energized circuit recommended in this manual.
- Disconnect the power to the circuit under test before connecting or disconnecting the probe.
- Before disconnecting the probe from the oscilloscope, first disconnect the probe input terminal from the circuit under test.

Observe All Terminal Ratings.

To avoid fire or electric shock, please observe all ratings and markings on the product. Before making any connections to the product, consult the User Guide of the product for more details about ratings. Do not connect the probe to any lead whose voltage exceeds its rating.

Do Not Operate without Covers.

Do not operate the product with covers or panels removed.

Do Not Operate with Suspected Failures.

If you suspect that there is damage to the product, have it inspected by RIGOL authorized personnel before further operations. Any maintenance, adjustment, or replacement to accessories must be performed by RIGOL authorized personnel.

Avoid Exposed Circuitry.

Do not touch exposed connectors and components after the power is connected.

Do Not Operate in Wet Conditions.

To avoid short circuit inside the instrument or electric shock, never operate the instrument in a humid environment.

Do Not Operate in an Explosive Atmosphere.

To avoid personal injuries or damage to the instrument, never operate the instrument in an explosive atmosphere.

Keep Product Surfaces Clean and Dry.

Clean with a Dry Cloth Only.

1.2 Maintenance Safety Summary

Only qualified maintenance personnel with relevant qualifications can perform maintenance operations. Before performing any maintenance operations, please read the "Maintenance Safety Summary" and "*General Safety Summary*".

Do Not Make Repairs Alone.

Do not make internal repairs or adjustments to this product unless there is someone on site who can provide first aid and resuscitation measures.

Disconnect the Power Supply.

To avoid electric shock, please first disconnect the power supply, and then disconnect the power cord from the main power supply.

Caution When Making Repairs.

Dangerous voltage or current may be present in this present. Disconnect the power and test leads before removing the protective panel to perform soldering or component replacement.

To avoid electric shock, do not touch the exposed connectors.

1.3 Safety Notices and Symbols

Safety Notices in this Manual:**WARNING**

Indicates a potentially hazardous situation or practice which, if not avoided, will result in serious injury or death.

**CAUTION**

Indicates a potentially hazardous situation or practice which, if not avoided, could result in damage to the product or loss of important data.

Safety Notices on the Product:

- **DANGER**

It calls attention to an operation, if not correctly performed, could result in injury or hazard immediately.

- **WARNING**
It calls attention to an operation, if not correctly performed, could result in potential injury or hazard.
- **CAUTION**
It calls attention to an operation, if not correctly performed, could result in damage to the product or other devices connected to the product.

Safety Symbols on the Product:



Hazardous Voltage



Safety Warning



Protective Earth Terminal

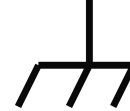

Chassis Ground

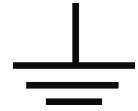

Test Ground

1.4 Working Environment

Temperature

Operating: 0°C to +40°C

Non-operating: -20°C to +70°C

Humidity

- **Operating:**
Below +40°C: 5% to 85% RH (without condensation)
- **Non-operating:**
Below +40°C: 5% to 85% RH (without condensation); +40°C to +70°C: 5% to 45% RH (without condensation)



WARNING

To avoid short circuit inside the instrument or electric shock, never operate the instrument in a humid environment.

Altitude

- **Operating:** below 3 km
- **Non-operating:** below 12 km

Equipment Type

Test and measurement equipment.

Pollution Degree

Pollution Degree 2

Pollution Degree Definitions

- **Pollution Degree 1:** No pollution or only dry, nonconductive pollution occurs. The pollution has no effect. For example, a clean room or air-conditioned office environment.
- **Pollution Degree 2:** Normally only nonconductive pollution occurs. Temporary conductivity caused by condensation is to be expected. For example, indoor environment.
- **Pollution Degree 3:** Conductive pollution or dry nonconductive pollution that becomes conductive due to condensation occurs. For example, sheltered outdoor environment.
- **Pollution Degree 4:** The pollution generates persistent conductivity caused by conductive dust, rain, or snow. For example, outdoor areas.

Overvoltage Category

Overvoltage category II



WARNING

Ensure that no overvoltage (such as that caused by a bolt of lightning) can reach the product. Otherwise, the operator might be exposed to the danger of an electric shock.

Overvoltage Category Definitions

- Category I is the low-voltage, low-energy level and applies to protected electronic equipment, e.g. the internal voltage of an electronic device.
- Category II is the low-voltage, high-energy level and refers to the branch circuits from the mains, e.g. 220 V light circuit at home.
- Category III is the high-voltage, high-energy level and refers to the mains circuit in fixed installations, e.g. 380 V three-phase voltage.
- Category IV is the three-phase at utility connection, any outdoor conductors.

1.5 Environmental Considerations

The following symbol indicates that this product complies with the WEEE Directive 2012/19/EU.



The equipment may contain substances that could be harmful to the environment or human health. To avoid the release of such substances into the environment and avoid harm to human health, we recommend you to recycle this product appropriately to ensure that most materials are reused or recycled properly. Please contact your local authorities for disposal or recycling information.

You can click on the following link <https://www.rigol.com/intl/services/environmental-protection-statement.html> to download the latest version of the RoHS&WEEE certification file.

2 Document Overview

This manual gives you a quick overview of the technical specifications and basic operation methods of the PIA1000 Series Optical-fiber Isolated Probe.



TIP

For the latest version of this manual, download it from RIGOL official website (<http://www.rigol.com>).

Publication Number

UGE37102-1110

Content Conventions in this Manual

The PIA1000 Series Optical-fiber Isolated Probe includes the following models. Unless otherwise specified, this manual takes PIA1100 as an example to illustrate the basic operations of the PIA1000 series.

Model	Bandwidth
PIA1020	200 MHz
PIA1050	500 MHz
PIA1100	1 GHz

3 General Inspection

1. Inspect the packaging

If the packaging has been damaged, do not dispose the damaged packaging or cushioning materials until the shipment has been checked for completeness and has passed both electrical and mechanical tests.

The consigner or carrier shall be liable for the damage to the instrument resulting from shipment. RIGOL would not be responsible for free maintenance/rework or replacement of the instrument.

2. Check the probe

In case of any mechanical damage, missing parts, or failure in passing the electrical and mechanical tests, contact your RIGOL sales representative.

3. Check the accessories

Please check the accessories according to the packing lists. If the accessories are damaged or incomplete, please contact your RIGOL sales representative.

4 Product Overview

4.1 Introduction

The PIA1000 Series Optical-fiber Isolated Probe offers exceptional performance and safety tests with its excellent common mode rejection capability and high isolated voltage. It achieves full-scale output in the differential mode voltage range from ± 0.01 V to ± 2500 V with various attenuating tips. The PIA1000 is powered over laser, offering a perfect solution for isolated power supply. Besides, it is compatible with the auto-recognized interface of RIGOL oscilloscopes (e.g. MSO8000, DHO4000). It simplifies the operation and improves the user experience with immediate test.

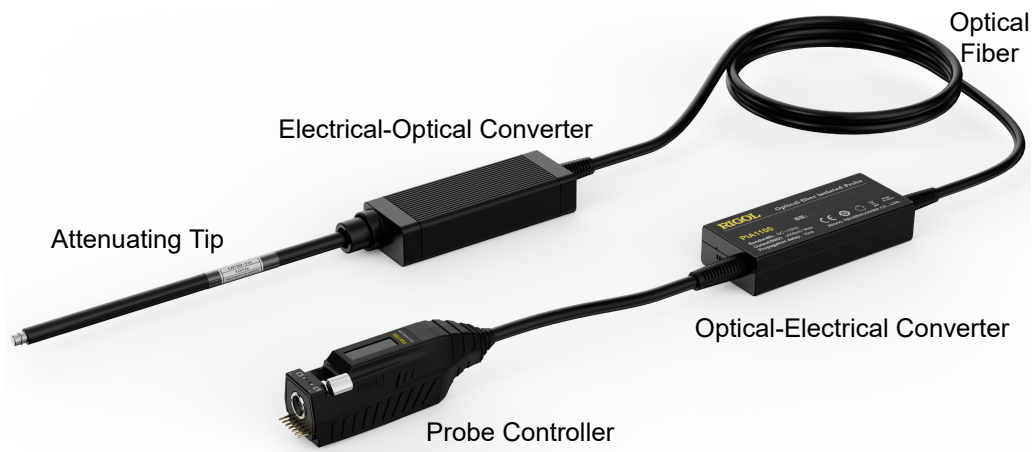

Figure 4.1 PIA1000 Series Optical-fiber Isolated Probe

Key Features

- High Bandwidth:
 - PIA1020: 200 MHz
 - PIA1050: 500 MHz
 - PIA1100: 1 GHz
- Common mode voltage up to 85 kVpk
- Differential mode voltages from ± 0.01 V to ± 2500 V with different attenuating tips
- High CMRR, up to 108 dB at 1 GHz
- Fast response, immediate test after power-on with no warm-up time, 1% accuracy at DC Gain

Applications

- Power device evaluation, current parallel measurement, EMI and ESD troubleshooting
- Motor drive design, power converter design, electronic ballast design
- Design and analysis of GaN, SiC, IGBT half/full bridge devices
- Test of inverters, UPS, and switching power supplies
- Safety isolation test for high voltage, high bandwidth test applications
- Wide voltage, wide band test applications
- Floating measurements

4.2 Probe Size

The figure below shows the main body of the PIA1000 Series Optical-fiber Isolated Probe.

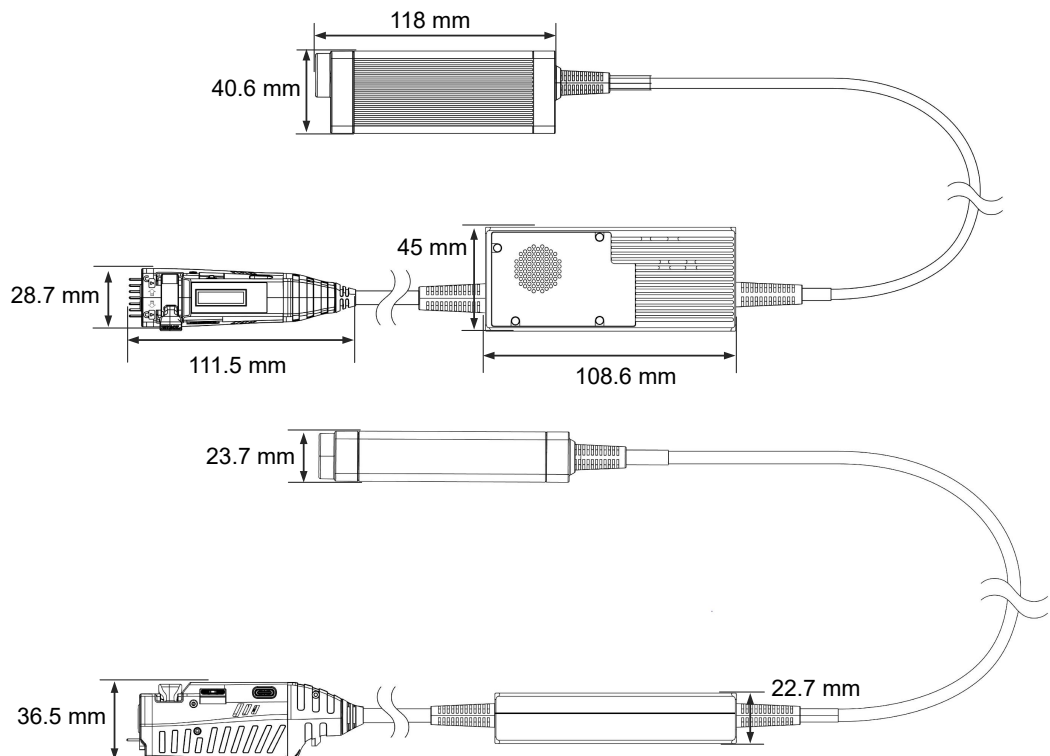

Figure 4.2 Probe Size

4.3 Electrical-Optical Converter

The Electrical-Optical converter converts the electrical signal under test into an optical signal and transmits it via optical fiber to the Optical-Electrical converter. The Electrical-Optical converter of the PIA1000 series is powered over fiber, no additional power supply required.



Figure 4.3 Electrical-Optical Converter

4.4 Optical-Electrical Converter

The Optical-Electrical converter can restore the optical signal transmitted by the Electrical-Optical converter to an electrical signal and input it to the oscilloscope via the probe controller.

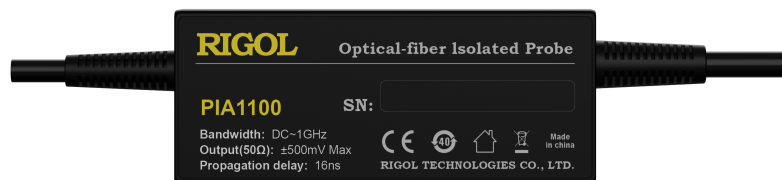

Figure 4.4 Optical-Electrical Converter

4.5 Probe Controller

The probe controller can be connected to the input interface of the RIGOL oscilloscope. You can use it to power the probe, set up communication, and set the attenuation ratio. Besides, the controller also provides a Type-C interface via which you can apply the power source (PD, 12 V, 3 A) to power the probe. The probe controller is as shown in the figure below.

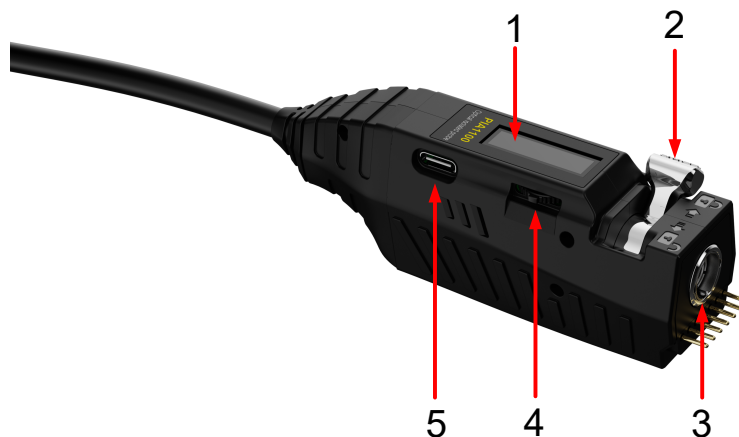

Figure 4.5 Probe Controller

1. 0.91" probe display, used to display the measurement information and the prompt message. The figure below shows the information on the display after the boot. You can switch between the displayed functions and select a function via the thumbwheel switch.



2. Locking lever. Push the lever to lock (🔒) or unlock (🔓) the connection between the probe and the oscilloscope interface.
3. Probe output connector, used to connect the input interface of the oscilloscope.
4. Thumbwheel switch. Scroll the thumb wheel to switch between functions of probe attenuation, probe calibration, and probe restart on the probe display. Press the thumb wheel to confirm the selection.
5. Type-C interface, used to connect the power source (PD, 12 V, 3 A) to power the probe. Using the Type-C interface to power the probe will disconnect the power supply from the oscilloscope.

4.6 Attenuating Tip

The attenuating tip is used to connect the Electrical-Optical converter to the DUT. To avoid the possible damage to the equipment, you must use an attenuating tip instead of connecting the Electrical-Optical converter directly to the circuit. The table below lists the attenuating tip models. Select the attenuating tip based on the peak voltage (or RMS voltage) of the signal under test. Please refer to *Specifications* for the technical specifications of different attenuating tips.



Figure 4.6 Attenuating Tip

Attenuating Tip Model	Description
TIP-MMCX-10X-02	10× attenuating tip with 200 MHz bandwidth
TIP-MMCX-20X-02	20× attenuating tip with 200 MHz bandwidth
TIP-MCX-500X-02	500× attenuating tip with 200 MHz bandwidth
TIP-MCX-1000X-02	1000× attenuating tip with 200 MHz bandwidth
TIP-MMCX-20X-05	20× attenuating tip with 500 MHz bandwidth
TIP-MMCX-50X-05	50× attenuating tip with 500 MHz bandwidth
TIP-MCX-1000X-05	1000× attenuating tip with 500 MHz bandwidth
TIP-MCX-2000X-05	2000× attenuating tip with 500 MHz bandwidth
TIP-MCX-5000X-05	5000× attenuating tip with 500 MHz bandwidth
TIP-MMCX-20X-1	20× attenuating tip with 1 GHz bandwidth
TIP-MMCX-50X-1	50× attenuating tip with 1 GHz bandwidth
TIP-MCX-1000X-1	1000× attenuating tip with 1 GHz bandwidth
TIP-MCX-2000X-1	2000× attenuating tip with 1 GHz bandwidth
TIP-MCX-5000X-1	5000× attenuating tip with 1 GHz bandwidth

5 To Use the Probe

This chapter illustrates how to use the probe safely and efficiently. Before installing and using the probe, read this chapter and *Safety Requirement* carefully to learn how to use the probe and understand the safety requirements including potential dangers.

5.1 Precautions and Safety Requirements

To use the probe safely, please read and understand the following precautions and safety requirements and observe them while using this product.



WARNING

- **Electrical shocks may occur when using this measurement system. The system is used to isolate the personnel from dangerous input voltages (common voltages); the plastic housing of the E-O converter and the shielding of the attenuating tip do not provide safe isolation. Keep a safe distance from the E-O converter and the attenuating tip when the measurement system is connected to the energized circuit recommended in this manual.**

Safe distance from the E-O converter and the attenuating tip when measuring high-voltage common-mode signals			
Common Mode Voltage (AC)	<10 kV	10 kV to 35 kV	>35 kV
Safe Distance	>0.7m	>1m	>1.5m

Safe distance from the E-O converter and the attenuating tip when measuring high-voltage common-mode signals			
Common Mode Voltage (AC)	<10 kV	10 kV to 35 kV	>35 kV
Safe Distance	>0.7m	>1m	>1.5m

- **Do not disassemble the electrical-optical converter or the optical-electrical converter. The measurement system contains a laser source which may result in laser exposure if disassembling the probe.**
- **To avoid the risk of electric shock, do not connect the measurement system to the energized circuit. Always disconnect the test circuit before installing or removing the attenuating tip from the circuit. The plastic housing of the electrical-optical converter and the shielding of the attenuating tip do not provide isolation.**
- **To avoid the risk of electric shock when the circuit under test is energized, do not touch the electrical-optical converter and its attenuating tip while testing. Always keep a safe distance from the electrical-optical converter during the test.**
- **To avoid arc flash caused by different potentials, do not place the attenuating tip in a circuit with different voltages.**

CAUTION



- **Do not put heavy objects on the fiber cable, such as running over the cable with a chair wheel or dropping a heavy object onto the cable.**
- **Do not block the heat dissipation port on the optical-electrical converter, otherwise the probe may be overheated and damaged.**

- **When disassembling and moving the probe, please hold the probe body by hand and do not lift or drag the cable to prevent breakage.**
- **The bending radius of the fiber cable cannot be less than 8 cm, otherwise it will lead to fiber breakage.**
- **Do not kink the cable.**
- **Accidental drop of the E-O or the O-E converter may cause damage to internal optical components.**
- **Please check damage to the fiber cable and stop use when there is damage to the soft rubber sheath.**
- **When not in use, store the optical-fiber isolated probe in its factory fitted carrying case (standard).**
- **To avoid possible damage to the device, please do not connect the interface of the Electrical-Optical converter directly to the circuit. Always use the attenuating tip.**



NOTE

Touching the E-O converter or attenuating tip when measuring high-frequency common mode signals will increase capacitance coupling and may decrease the common mode load of the test circuit.

5.2 To Install and Remove the Attenuating Tip

To avoid possible damage to the device, please do not connect the interface of the Electrical-Optical converter directly to the circuit. Use an attenuating tip.

To install the attenuating tip, follow the steps below.

1. Line up the notch of the attenuating tip with the hook of the E-O converter connector and insert the attenuating tip to the connector of the E-O converter.



2. Tighten the lock nut of the attenuating tip clockwise.



To remove the attenuating tip, screw off the lock nut of the attenuating tip counter-clockwise and then gently hold the attenuating tip to remove it from the converter. Do not pull or drag the attenuating tip during the process.



CAUTION

- Do not bend or drag the attenuating tip and fiber when installing or removing the tip.
- Please select a proper attenuating tip for the measurement to avoid damage to the Electric-Optical converter or degradation of performance due to overvoltage.



TIP

Please select the attenuating tip with the lowest attenuation ratio allowed by the range of the signal under test.

5.3 Measurement Steps

Please read *Precautions and Safety Requirements* carefully before measurements.

1. Make sure that the DUT has no power applied.
2. Connect the probe controller to the input terminal of the oscilloscope. After that, pull the locking lever to the lock position (🔒).

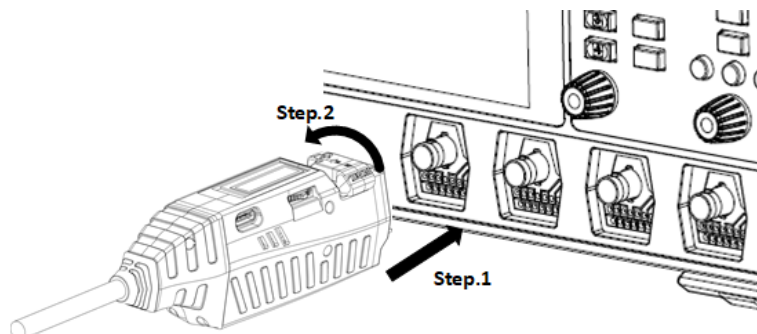

TIP

- Before the connection, make sure that the locking lever of the probe controller is in the unlock position (🔓).

- Before removing the probe, please pull the locking lever to unlock (🔓) the connection.
3. Set the input impedance to 50 Ω for the corresponding channel and set the corresponding attenuation ratio and delay time.
 4. Connect the attenuating tip to the electrical-optical converter (see *To Install and Remove the Attenuating Tip*).
 5. Solder the adapter to the test board.



NOTE

- When testing Vgs signals, the signal pin (in the middle) of the adapter must be connected to the G-end of the MOSFET.
- Solder the adapter directly to the test point. Try not to use the extension lead or it may bring unsatisfactory test results.
- For easy soldering, suggest to cut three of the four ground pins around the base, just keep one.

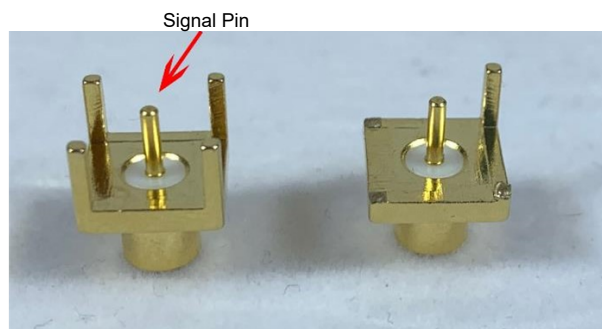

6. Plug the attenuating tip to the adapter. A click heard indicates that the connection is successful.
7. Power on the DUT.
8. Adjust the oscilloscope settings and proceed normal test.

5.4 To Calibrate the Probe

Before using the PIA1000 Series Optical-fiber Isolated Probe, you need to calibrate the probe. You can calibrate the probe either on the oscilloscope or on the probe controller.

Calibrate the Probe via the Oscilloscope

To calibrate the probe via the oscilloscope, follow the steps below.

1. Connect the probe to the analog channel of the oscilloscope (taking the CH1 of DHO4000 as an example).
2. Click or tap the channel status label at the bottom of the screen to open the Vertical menu. Then click or tap **Probe** > **CH1** > **Calibration** and the oscilloscope

will calibrate the probe automatically. The calibration takes about 10 seconds. After the calibration is completed, the prompt message "Probe calibrated successfully" or "Probe calibration failure" will be displayed on the oscilloscope based on the calibration result.





TIP

The calibration operation may differ for different oscilloscope models. For details, refer to the User Guide of your oscilloscope.

Calibrate the Probe via the Probe Controller

To calibrate the probe via the probe controller, follow the steps below.

1. Connect the probe to the analog channel of the oscilloscope.
2. Pull the thumbwheel switch of the probe controller to select the calibration

function  on the display. Then press the thumbwheel switch to start the probe calibration. The calibration result will be displayed on the display of the probe controller (pass:  or fail: .



NOTE

The specification of the PIA1000 series depends on the calibration of the probe. After the calibration is completed, the DC gain, offset voltage zero point, and offset gain are calibrated. After the probe is connected, you can check the probe information including the vendor, model, serial number, and the last calibration time on the probe setting menu. After power-on, the PIA1000 only requires one manual calibration at most. No more calibration is required to ensure measurement accuracy.

6 Specifications

All technical specifications are typical values unless otherwise noted. Technical specifications are valid when:

- The probe is calibrated at $23^{\circ}\text{C} \pm 5^{\circ}\text{C}$ ambient temperature
- The probe is powered by normal power supply
- The temperature, altitude, and humidity of the environment in which the probe is located cannot exceed the limits of the stated environmental requirements.

Technical Specifications

Characteristics	PIA1020	PIA1050	PIA1100
Bandwidth	200 MHz	500 MHz	1 GHz
Rise Time	≤ 1.75 ns	≤ 700 ps	≤ 450 ps
CMRR	DC: 180 dB 200 MHz: 122 dB	DC: 180 dB 500 MHz: 114 dB	DC: 180 dB 1 GHz: 108 dB
Propagation Delay	18.5 ns (2 m fiber length)	17.2 ns (2 m fiber length)	17.2 ns (2 m fiber length)
Output Voltage Range	± 1.25 V	± 500 mV	± 500 mV
Noise	≤ 2 mVrms@0 dB ≤ 400 μ Vrms@20 dB	≤ 2.4 mVrms@0 dB ≤ 420 μ Vrms@20 dB	≤ 2.4 mVrms@0 dB ≤ 420 μ Vrms@20 dB
Power Supply	Power supply from the oscilloscope's probe interface or the Type-C interface		
DC Gain Accuracy ^[1] (Typical)	1%		
Common Mode Voltage	85 kVpk		
Certification	IEC60825-1		

NOTE

[1]: When the signal is much greater than the oscilloscope's system noise, it is recommended to use the oscilloscope's ± 3 div DC signal.



Attenuating Tip

Probe Model	Atten. Tip	Atten. Ratio	Input Voltage Range	Non-destructive Voltage (Max.)	Input Impedance (Typ.)
PIA1020	TIP-MMCX-10X-02	10:1	± 12.5 V	1000 Vpp	3.75 M Ω 6 pF
		1:1	± 1.25 V		
	TIP-MMCX-20X-02	20:1	± 25 V	1000 Vpp	4.47 M Ω 4 pF
		2:1	± 2.5 V		
	TIP-MCX-500X-02	500:1	± 625 V	2500 Vpp	20.20 M Ω 1 pF
		50:1	± 62.5 V		
TIP-MCX-1000X-02	1000:1	± 1250 V	2500 Vpp	20.21 M Ω 1 pF	
	100:1	± 125 V			
PIA1050	TIP-MMCX-20X-05	20:1	± 10 V	1000 Vpp	4.47 M Ω 4 pF
		2:1	± 1 V		
	TIP-MMCX-50X-05	50:1	± 25 V	1000 Vpp	4.19 M Ω 2 pF
		5:1	± 2.5 V		
	TIP-MCX-1000X-05	1000:1	± 500 V	2500 Vpp	20.21 M Ω 1 pF
		100:1	± 50 V		
	TIP-MCX-2000X-05	2000:1	± 1000 V	2500 Vpp	20.08 M Ω 1 pF
		200:1	± 100 V		
	TIP-MCX-5000X-05	5000:1	± 2500 V	3600 Vpp	40.16 M Ω 1 pF
		500:1	± 250 V		
PIA1100	TIP-MMCX-20X-1	20:1	± 10 V	1000 Vpp	4.47 M Ω 4 pF
		2:1	± 1 V		
	TIP-MMCX-50X-1	50:1	± 25 V	1000 Vpp	4.19 M Ω 2 pF
		5:1	± 2.5 V		
	TIP-MCX-1000X-1	1000:1	± 500 V	2500 Vpp	20.21 M Ω 1 pF
		100:1	± 50 V		
	TIP-MCX-2000X-1	2000:1	± 1000 V	2500 Vpp	20.08 M Ω 1 pF
		200:1	± 100 V		
	TIP-MCX-5000X-1	5000:1	± 2500 V	3600 Vpp	40.16 M Ω 1 pF
		500:1	± 250 V		

Adapters and Coaxial Cable

Accessory Type	Withstand Voltage Range
MCX Adapter	< 3000 Vpp
MMCX Adapter	< 300 Vpp
MCX Coaxial Cable	< 3000 Vpp

Accessory Type	Withstand Voltage Range
MMCX Coaxial Cable	<300 Vpp
LCX Coaxial Cable	<8000 Vpp

Mechanical Characteristics

Characteristics	Specification
Fiber Length (E-O Converter to O-E Converter)	2 m
Cable Length (O-E Converter to Probe Controller)	25 cm
Optical-Electrical Converter Size	108.6 mm x 45 mm x 22.7 mm
Electrical-Optical Converter Size	118 mm x 40.6 mm x 23.7 mm
Probe Controller	111.5 mm x 28.7 mm x 36.5 mm

Environmental Characteristics

Environmental Characteristics	Status	Specification
Temperature	Operating	Optical-Electrical converter: 0°C to +40°C Electrical-Optical converter: 0°C to +40°C
	Non-operating	Optical-Electrical converter: -20°C to +70°C Electrical-Optical converter: -20°C to +70°C
Humidity	Operating	Optical-Electrical converter: 5% to 85% RH (relative humidity) below +40°C, without condensation Electrical-Optical converter: 5% to 85% RH (relative humidity) below +40°C, without condensation
	Non-operating	Optical-Electrical converter: 5% to 85% RH (relative humidity) below +40°C; 5% to 45% RH at +40°C to +70°C, without condensation Electrical-Optical converter: 5% to 85% RH (relative humidity) below +40°C; 5% to 45% RH at +40°C to +70°C, without condensation

Environmental Characteristics	Status	Specification
Altitude	Operating	3000 meters
	Non-operating	12,000 meters

Amplitude Frequency Characteristic Curve

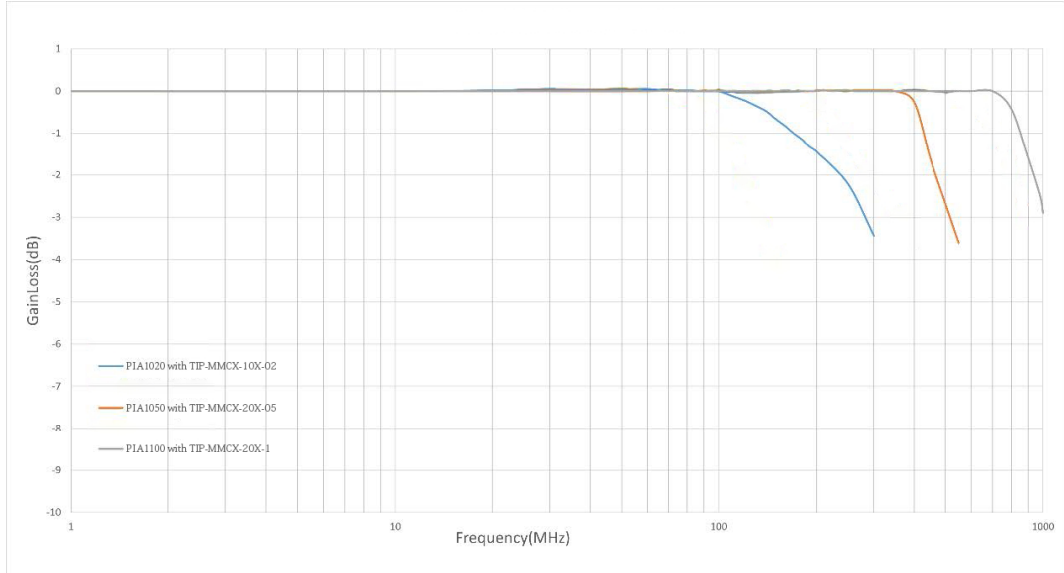

The figure above shows the amplitude-frequency characteristics of different probe models.

Attenuating Tip CMRR Curve

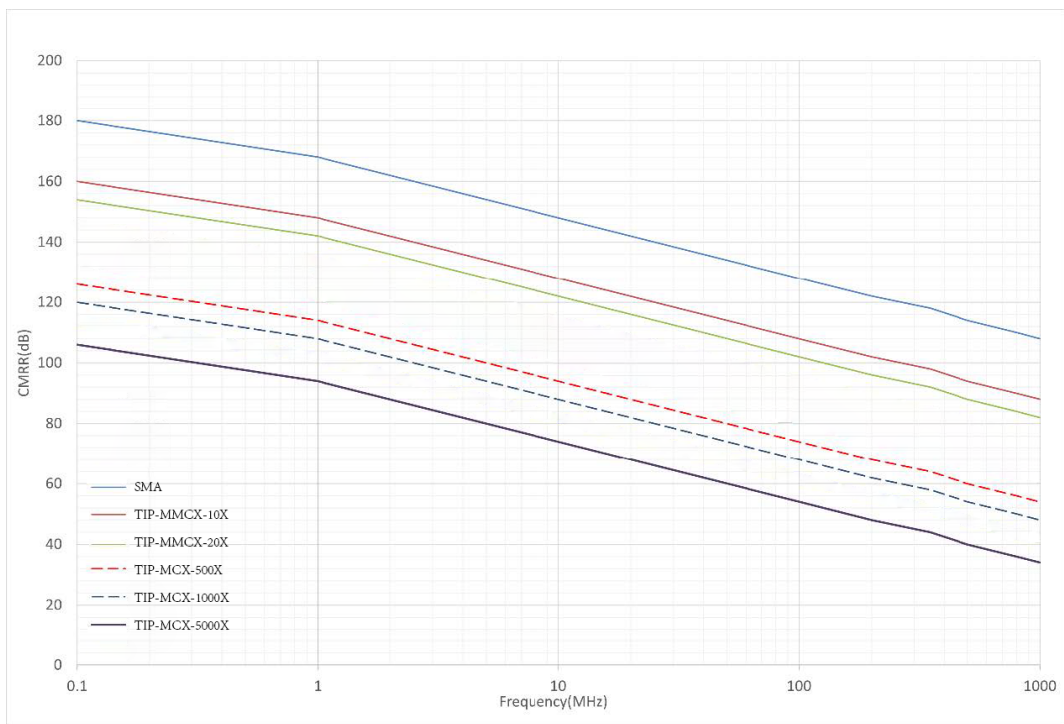















The figure above shows the common mode rejection capabilities of different attenuating tips (0dB) at various frequencies.

7 Maintenance

7.1 Troubleshooting

The probe display can indicate the current status of the probe. If you encounter the following prompt messages when using the probe or certain functions of the probe are not working, use the following table as a quick troubleshooting reference. If the problem still persists, please contact RIGOL.

Prompt Message	Description	Possible Causes and Solutions
 	Abnormal temperature of the Electrical-Optical converter	The temperature of the Electrical-Optical converter is overheated. Please stop using it and wait for the probe to cool down.
 	Abnormal temperature of the Optical-Electrical Converter	The temperature of the Optical-Electrical converter is overheated. Please check whether the heat dissipation port is blocked.
 	Abnormal hardware operation	Restart the probe.
 	Overvoltage warning	The input voltage is out of range. Please select another suitable attenuating tip.
 	Attenuating tip error	No attenuating tip is installed. Please refer to <i>To Install and Remove the Attenuating Tip</i> to install the attenuating tip.
 	The attenuating tip does not match the probe	Use an applicable attenuating tip.
 	The probe needs to be calibrated	Refer to <i>To Calibrate the Probe</i> to calibrate the probe.

7.2 Care and Cleaning

Care

Do not expose the probe to harsh environments. When not in use, store the optical-fiber isolated probe in its factory fitted carrying case (standard).



CAUTION

Do not expose the probe and its accessories to caustic liquids.

Cleaning

Clean the probe and its accessories according to the operating conditions.

1. Disconnect the probe from the oscilloscope or the power source.
2. Clean the outer surface and its accessories with a dry, non-linting soft cloth or a soft bristle brush.



CAUTION

- **Do not wipe the probe with chemical cleaners to avoid possible damage to the probe.**
- **The probe is not waterproof and to avoid damage to the probe, do not expose it to sprays, liquids, or solvents. Avoid wetting the inside when performing exterior cleaning of the probe.**

8 Appendix

8.1 Appendix A: Order Information

Order Information	Description
Probe Model	
PIA1020	200 MHz optical-fiber isolated probe, 2-meter cable
PIA1050	500 MHz optical-fiber isolated probe, 2-meter cable
PIA1100	1 GHz optical-fiber isolated probe, 2-meter cable
Standard Accessories	
Applicable Attenuating Tips	PIA1020: TIP-MMCX-20X-02 (standard) PIA1050: TIP-MMCX-50X-05 and TIP-MCX-2000X-05 (standard) PIA1100: TIP-MMCX-50X-1 and TIP-MCX-2000X-1 (standard)
MCX Adapter (2.54mm spacing) *5	Connecting the optical-fiber isolated probe and the circuit under test
MCX Adapter (5.08mm spacing) *5	Connecting the optical-fiber isolated probe and the circuit under test
MMCX Coaxial Cable *1	Connecting the optical-fiber isolated probe and the circuit under test
MCX Coaxial Cable *1	Connecting the optical-fiber isolated probe and the circuit under test
Carrying Case *1	Custom suitcase for 2 m cables, with foam insert to protect the optical-fiber isolated probe and the fiber
Probe Mount *1	Tripod mount to support the probe
Packing list *1	A list of all accessories for the optical-fiber isolated probe

Order Information	Description
Optional Attenuating Tip	
TIP-MMCX-10X-02	10× attenuating tip with 200 MHz bandwidth
TIP-MCX-500X-02	500× attenuating tip with 200 MHz bandwidth
TIP-MCX-1000X-02	1000× attenuating tip with 200 MHz bandwidth
TIP-MMCX-20X-05	20× attenuating tip with 500 MHz bandwidth
TIP-MCX-1000X-05	1000× attenuating tip with 500 MHz bandwidth
TIP-MCX-5000X-05	5000× attenuating tip with 500 MHz bandwidth
TIP-MMCX-20X-1	20× attenuating tip with 1 GHz bandwidth
TIP-MCX-1000X-1	1000× attenuating tip with 1 GHz bandwidth
TIP-MCX-5000X-1	5000× attenuating tip with 1 GHz bandwidth

The attenuating tip configuration is as follows:

Probe Model	Standard Attenuating Tip	Optional Attenuating Tip
PIA1020	TIP-MMCX-20X-02	TIP-MMCX-10X-02 TIP-MCX-500X-02 TIP-MCX-1000X-02
PIA1050	TIP-MMCX-50X-05 TIP-MCX-2000X-05	TIP-MMCX-20X-05 TIP-MCX-1000X-05 TIP-MCX-5000X-05
PIA1100	TIP-MMCX-50X-1 TIP-MCX-2000X-1	TIP-MMCX-20X-1 TIP-MCX-1000X-1 TIP-MCX-5000X-1

8.2 Appendix B: Warranty

RIGOL TECHNOLOGIES CO., LTD. (hereinafter referred to as RIGOL) warrants that the product mainframe and product accessories will be free from defects in materials and workmanship within the warranty period. If a product proves defective within the warranty period, RIGOL guarantees free replacement or repair for the defective product.

To get repair service, please contact your nearest RIGOL sales or service office.

There is no other warranty, expressed or implied, except such as is expressly set forth herein or other applicable warranty card. There is no implied warranty of merchantability or fitness for a particular purpose. Under no circumstances shall RIGOL be liable for any consequential, indirect, ensuing, or special damages for any breach of warranty in any case.

Boost Smart World and Technology Innovation

Industrial Intelligent
Manufacturing



Semiconductors

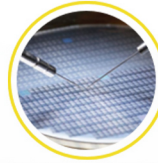

Education &
Research

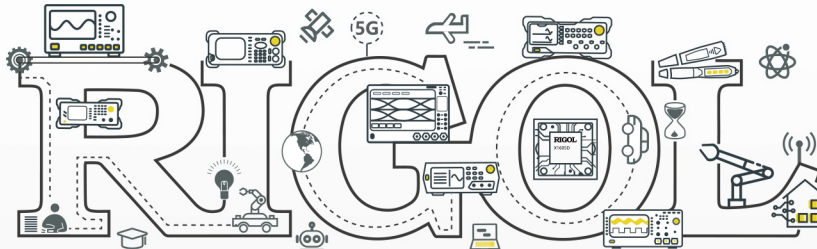

Communication

System Integration

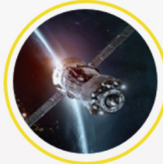

New Energy



- 5G Cellular-5G/WIFI
- UWB/RFID/ ZIGBEE
- Digital Bus/Ethernet
- Optical Communication

- Digital/Analog/RF Chip
- Memory and MCU Chip
- Third-Generation Semiconductor
- Solar Photovoltaic Cells

- New Energy Automobile
- PV/Inverter
- Power Test
- Automotive Electronics

*Provide Testing and Measuring Products
and Solutions for Industry Customers*

HEADQUARTER

RIGOL TECHNOLOGIES CO., LTD.
No.8 Keling Road, New District,
Suzhou, JiangSu, P.R.China
Tel: +86-400620002
Email: info-cn@rigol.com

JAPAN

RIGOL JAPAN CO., LTD.
5F, 3-45-6, Minamiotsuka, Toshima-Ku,
Tokyo, 170-0005, Japan
Tel: +81-3-6262-8932
Fax: +81-3-6262-8933
Email: info.jp@rigol.com

EUROPE

RIGOL TECHNOLOGIES EU GmbH
Friedrichshafener Str. 5
82205 Gilching
Germany
Tel: +49(0)8105-27292-21
Email: info-europe@rigol.com

KOREA

RIGOL KOREA CO., LTD.
5F, 222, Gonghang-daero,
Gangseo-gu, Seoul, Republic of Korea
Tel: +82-2-6953-4466
Fax: +82-2-6953-4422
Email: info.kr@rigol.com

NORTH AMERICA

RIGOL TECHNOLOGIES, USA INC.
10220 SW Nimbus Ave.
Suite K-7
Portland, OR 97223
Tel: +1-877-4-RIGOL-1
Email: sales@rigol.com

For Assistance in Other Countries

Email: info.int@rigol.com

RIGOL® is the trademark of **RIGOL TECHNOLOGIES CO., LTD.** Product information in this document is subject to update without notice. For the latest information about **RIGOL's** products, applications and services, please contact local **RIGOL** channel partners or access **RIGOL** official website: www.rigol.com