

# **RIGOL**

## **Quick Guide**

**English**

# **DSG3000B Series RF Signal Generator**

**Aug. 2020**

**RIGOL TECHNOLOGIES CO., LTD.**



---

# Guaranty and Declaration

## Copyright

© 2020 **RIGOL** TECHNOLOGIES CO., LTD. All Rights Reserved.

## Trademark Information

**RIGOL**® is the trademark of **RIGOL** TECHNOLOGIES CO., LTD.

English

## Publication Number

QGG03100-1110

## Notices

- **RIGOL** products are covered by P.R.C. and foreign patents, issued and pending.
- **RIGOL** reserves the right to modify or change parts of or all the specifications and pricing policies at the company's sole decision.
- Information in this publication replaces all previously released materials.
- Information in this publication is subject to change without notice.
- **RIGOL** shall not be liable for either incidental or consequential losses in connection with the furnishing, use, or performance of this manual, as well as any information contained.
- Any part of this document is forbidden to be copied, photocopied, or rearranged without prior written approval of **RIGOL**.

## Product Certification

**RIGOL** guarantees that this product conforms to the national and industrial standards in China as well as the ISO9001:2015 standard and the ISO14001:2015 standard. Other international standard conformance certifications are in progress.

## Contact Us

If you have any problem or requirement when using our products or this manual, please contact **RIGOL**.

E-mail: [service@rigol.com](mailto:service@rigol.com)

Website: [www.rigol.com](http://www.rigol.com)

## General Safety Summary

1. Only the exclusive power cord designed for the instrument and authorized for use within the local country could be used.
2. Ensure that the instrument is safely grounded.
3. Observe all terminal ratings.
4. Use proper overvoltage protection.
5. Do not operate without covers.
6. Do not insert objects into the air outlet.
7. Use the proper fuse.
8. Avoid circuit or wire exposure.
9. Do not operate the instrument with suspected failures.
10. Provide adequate ventilation.
11. Do not operate in wet conditions.
12. Do not operate in an explosive atmosphere.
13. Keep instrument surfaces clean and dry.
14. Prevent electrostatic impact.
15. Handle with caution.

English

## Safety Notices and Symbols

### Safety Notices in this Manual:



#### **WARNING**

Indicates a potentially hazardous situation or practice which, if not avoided, will result in serious injury or death.



#### **CAUTION**

Indicates a potentially hazardous situation or practice which, if not avoided, could result in damage to the product or loss of important data.

### Safety Terms on the Product:

#### **DANGER**

It calls attention to an operation, if not correctly performed, could result in injury or hazard immediately.

#### **WARNING**

It calls attention to an operation, if not correctly performed, could result in potential injury or hazard.

#### **CAUTION**

It calls attention to an operation, if not correctly performed, could result in damage to the product or other devices connected to the product.

## Safety Symbols on the Product:



Hazardous  
Voltage



Safety  
Warning



Protective Earth  
Terminal



Chassis Ground



Test Ground

English

## Care and Cleaning

### Care

Do not store or leave the instrument where it may be exposed to direct sunlight for long periods of time.

### Cleaning

Clean the instrument regularly according to its operating conditions. **WARNING**

1. Disconnect the instrument from all power sources.
2. Clean the external surfaces of the instrument with a soft cloth dampened with mild detergent or water. Avoid having any water or other objects into the chassis via the heat dissipation hole. When cleaning the LCD, take care to avoid scarifying it.



### CAUTION

To avoid damage to the instrument, do not expose it to caustic liquids.



### WARNING

To avoid short-circuit resulting from moisture or personal injuries, ensure that the instrument is completely dry before connecting it to the power supply.

# Document Overview

This manual gives you a quick review about the basic information of DSG3000B when you use it for the first time, including general inspection, product overview, how to connect to power, turn-on checkout, remote control, and etc.

## Tip

For the latest version of this manual, download it from the official website of **RIGOL** ([www.rigol.com](http://www.rigol.com)).

## Format Conventions in this Manual

### 1. Key

The key on the front panel is denoted by the format of "Key Name (Bold) + Text Box" in the manual. For example, **FREQ** denotes the **FREQ** key.

### 2. Menu

The menu items are denoted by the format of "Menu Word (Bold) + Character Shading". For example, **Frequency** denotes the "Frequency" menu item under **FREQ**.

### 3. Connector

The connectors on the front or rear panel are usually denoted by the format of "Connector Name (Bold) + Square Brackets (Bold)". For example, **[RF OUTPUT 50Ω]**.

### 4. Operation Predures

The next step of the operation is denoted by an arrow "→" in the manual. For example, **FREQ** → **Frequency** denotes pressing **FREQ** on the front panel first and then pressing **Frequency**.

## Content Conventions in this Manual

The DSG3000B series RF signal generator includes DSG3065B, DSG3065B-IQ, DSG3136B, and DSG3136B-IQ. This manual takes DSG3136B-IQ as an example to illustrate the functions and operation methods of DSG3000B series.

## Manuals of this Product

Quick Guide, User Guide, Programming Guide, Data sheet, etc. For the latest version of this manual, download it from the official website of **RIGOL** ([www.rigol.com](http://www.rigol.com)).

---

# General Inspection

## 1. **Inspect the packaging**

If the packaging has been damaged, do not dispose the damaged packaging or cushioning materials until the shipment has been checked for completeness and has passed both electrical and mechanical tests.

The consigner or carrier shall be liable for the damage to the instrument resulting from shipment. **RIGOL** would not be responsible for free maintenance/rework or replacement of the instrument.

## 2. **Inspect the instrument**

In case of any mechanical damage, missing parts, or failure in passing the electrical and mechanical tests, contact your **RIGOL** sales representative.

## 3. **Check the accessories**

Please check the accessories according to the packing lists. If the accessories are damaged or incomplete, please contact your **RIGOL** sales representative.

English

## Product Overview

The DSG3000B series is a high-performance RF signal generator. It provides comprehensive modulation solutions: AM/FM/ϕM analog modulation; pulse modulation with user-defined pulse train; and I/Q modulation. All the modulations support internal and external modulation sources. In addition, to meet the demands of production environments, the DSG3000B series has undergone a strict verification through the experiments in its design and production stages to ensure its high stability and reliability. The DSG3000B series also features a clear user interface, compact size and light weight. It is easy to operate and can output stable, precise and pure signals. It is an ideal tool in various fields such as communication, computers, instrumentation, R&D, education, production and maintenance.

## Front Panel Overview

The front panel of DSG3000B series RF signal generator is as shown in the figure below. Click the number in the figure to view the corresponding introduction.

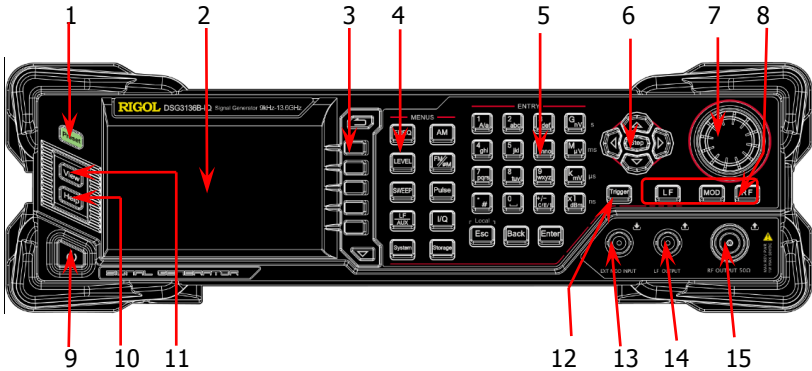

Figure 1 Front Panel

### 1. Restore to Preset Key



Restore the instrument to the preset state (factory state or user-stored state).



## 2. LCD Display

4.3-inch TFT high-resolution (480×272) color LCD display. The current settings and state of the instrument can be clearly displayed. For detailed information, refer to "**User Interface**".

## 3. Menu Control Keys

English



Quit the current menu and return to the previous menu.



Menu softkey. Corresponds to the menu label at the left of the softkey on the display. Press the softkey to activate the corresponding menu.



Menu page up/down key.

## 4. Function Keys



Set the frequency, frequency offset and phase offset of the RF output signal.



Set the amplitude of the RF output signal and provide the flatness calibration function.



Set the sweep type, sweep manner and sweep mode.



Set the parameters relating to amplitude modulation (AM).



Set the parameters relating to frequency modulation (FM) and phase modulation ( $\phi M$ ).



Set the parameters relating to pulse modulation and pulse generator.



Set the parameters relating to I/Q modulation and I/Q modulation source.



Set the parameters relating to LF output.



Store and recall state files and other types of files.



Set the system-related parameters.

## 5. Numeric Keyboard

The numeric keyboard supports Chinese characters, English uppercase /lowercase characters, numbers and commonly used symbols (include the decimal point, #, space and positive/negative sign+/-). It is mainly used to edit the file or folder name or set parameters.

The multiplexing key of number and letter is used to directly input the desired number or letter.



Used to switch among Chinese, English and number input modes.

When setting parameters, the input mode is fixed at number and this key is used to input the sign ("+" or "-") of the value.



In number input mode, press this key to input 1.  
In English input mode, press this key to switch between uppercase and lowercase letter input.



The multiplexing key of 0 and space:  
In number input mode, press this key to input 0.  
In Chinese or English input mode, press this key to input a space.



In number input mode, press this key to insert a decimal point at the current cursor.  
In English input mode, press this key to input "#".  
In Chinese input mode, this key is invalid.

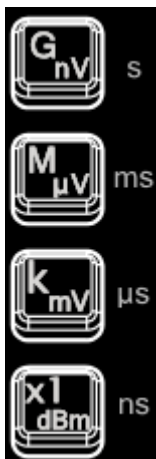

Used to set the unit of the parameter.  
When setting a parameter, after using the numeric keyboard to input the numbers, press one of these keys to select the corresponding unit. The unit selected is related to the type of the parameter to be set.

Parameter	GnV	M $\mu$ V	kmV	X1dBm
Frequency	GHz	MHz	kHz	Hz
Amplitude	nV	$\mu$ V	mV	dBm
Period	s	ms	$\mu$ s	ns



When setting parameters, use this key to clear the number in the editing window and exit the parameter input state.

When editing filenames, use this key to clear the characters in the input bar.

During the keyboard test, use this key to exit the current test state.

When the instrument is in remote mode, use this key to return to local mode.

English



When setting parameters, use this key to delete the number at the left of the cursor.  
 When editing filenames, use this key to delete the character at the left of the cursor.  
 For the storage function, it is used to collapse the directory currently selected.



When setting parameters, use this key to finish the parameter input and add the default unit for the parameter.  
 When editing filenames, use this key to input the character currently selected by the cursor.  
 For the storage function, it is used to expand the directory currently selected.

## 6. Arrow Keys/Step Key



When setting the parameters, **Step** is used to set the step of the parameter currently selected.  
 The left/right arrow keys are used to enter the parameter editing state and move the cursor to the specified digit.  
 The up/down arrow keys are used to modify the value at the cursor or modify the parameter value at the current step.  
 For the storage function, the left/right arrow keys are used to collapse or expand the directory currently selected.  
 The up/down arrow keys are used to select the current directory or file.  
 When editing filenames, they are used to select the desired character.

## 7. Knob



When setting parameters, the knob is used to modify the value at the cursor or modify the parameter value at the current step.  
 When editing filenames, it is used to select the desired character.  
 For the storage function, it is used to select the current directory or file.

## 8. Output Control Keys



Used to turn on or off the LF output.

- Press this key, the backlight lights on and the LF label is displayed in the status bar in the user interface. The LF output is turned on. At this point, the **[LF OUTPUT]** connector outputs the LF signal according to the current configuration.
- Press this key again, the backlight goes out and the LF output is turned off.

English



Used to turn on or off the RF output.

- Press this key, the backlight lights on and the RF label is displayed in the status bar in the user interface. The RF output is turned on. At this point, the **[RF OUTPUT 50Ω]** connector outputs RF signal or RF sweep signal according to the current configuration.
- Press this key again, the backlight goes out and the RF output is turned off.



Used to turn on or off the RF modulation output.

- Press this key, the backlight lights on and the MOD label is displayed in the status bar in the user interface. The RF modulation output is turned on. At this point, the **[RF OUTPUT 50Ω]** connector outputs modulated RF signal according to the current configuration (the backlight of **[RF]** must light on).
- Press this key again, the backlight goes out and the RF modulation output is turned off.

## 9. Power Key



Turn on or off the signal generator. When this key is turned off, the signal generator is in standby state, indicated by a pulsing LED. In addition, this key has a delayed switching function. The instrument can be turned on or off only when pressing this key and holding it down for a certain

time. With this feature, you can avoid turning off the instrument because of accidentally touching the key.

Press **System** → **Power Status** to select "Open" or "Default". When "Default" is selected, after the instrument is powered on, you need to press this key to start the instrument. When "Open" is selected, the instrument will start automatically after it is powered on.

## 10. Built-in Help System



To get the help information of any front panel key or menu softkey, press this key and then press the desired key.

## 11. View Switch Key



It is used to switch the interface display mode to normal mode or parameter zoom-in mode. For details, please refer to "**User Interface**".

## 12. Trigger Control Key



When the trigger type of **SWEEP** is "Key", press this key once to trigger a sweep.

When the trigger mode of **Pulse** is "Key", press this key once to enable a pulse modulation.

## 13. External Modulation Input Connector

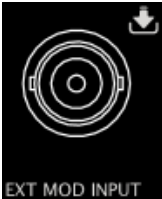

When the modulation source of AM, FM and  $\phi$ M is external, this connector is used to input the external modulating signal.

#### 14. LF Output Connector



When the backlight of **LF** lights on, this connector is used to output LF signal.

English

#### 15. RF Output Connector



When the backlight of **RF** lights on, this connector is used to output RF signal and RF sweep signal.

When the backlights of **RF** and **MOD** light on, this connector is used to output RF modulated signal.



#### **CAUTION**

To avoid damage to the instrument, the reverse DC voltage on the RF output connector cannot exceed 50 V, and the reverse power must be less than 1 W.

# Rear Panel Overview

The rear panel of DSG3000B series RF signal generator is as shown in the figure below. Click the number in the figure to view the corresponding introduction.

English

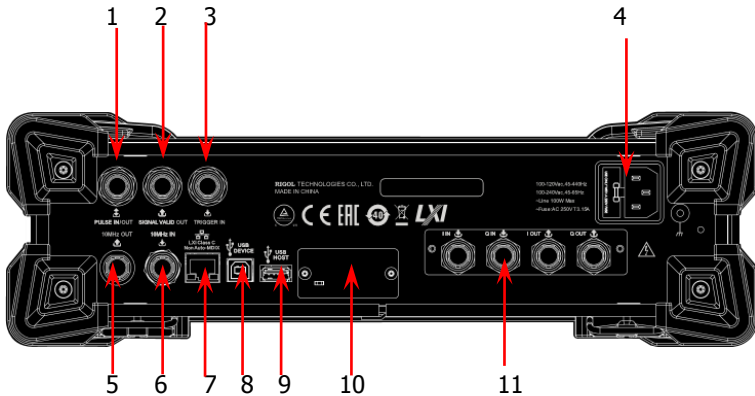
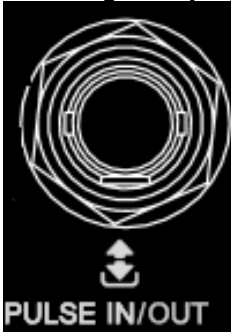

Figure 2 Rear Panel

## 1. Pulse Signal Input/Output Connector



The function of this connector is determined by the current working mode of the pulse modulation.

### **PULSE IN:**

When the modulation source of **Pulse** is external, this connector is used to input the external pulse signal.

### **PULSE OUT:**

When the modulation source of **Pulse** is internal and the switch of pulse output is "on", this connector is used to output the pulse signal of the internal generator. This output signal is related to the choice of pulse mode which can be set to "Single" or "Train".



## 2. Signal Valid Output Connector



When the RF output frequency or amplitude is modified, after a certain response and processing time, the internal circuit of the instrument outputs RF signal with specified frequency and amplitude via the RF output connector on the front panel. During this process, the **[SIGNAL VALID OUT]** connector outputs a pulse sync signal, indicating that the RF output signal is valid.

- High Level (+3.3 V): indicates that the RF signal is in configuration;
- Low Level (0 V): indicates that the RF signal is stable (namely, the signal is valid).

## 3. External Trigger Input Connector



When the trigger type of **[SWEEP]** is "Ext", this connector is used to input the external trigger signal. You can set the polarity of trigger signal by pressing **Trig Slope** to select "Pos" or "Neg".

When the trigger mode of I/Q modulation baseband output is "Ext", this connector is used to input the external trigger signal. When the pulse modulation source is "Int" and the trigger mode is "Ext Trig", it is used to input the external trigger signal. When the pulse modulation source is "Int" and the trigger mode is "Ext Gate", it is used to input the external gated signal.

## 4. Power Input Connector, Fuse and Switch

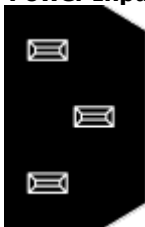

Power input connector.

This signal generator supports 100-240 V, 45-440 Hz; 100-240 Vac, 45-65 Hz. The power consumption of the instrument cannot exceed 100 W. When the signal generator is connected to AC power supply via this connector, the instrument selects the correct voltage range

automatically and users do not need to select the voltage range manually.

Fuse.

The fuse specification of this signal generator is AC 250 V, T3.15A.

If the fuse needs to be replaced, please refer to "**To Replace the Fuse**".



English

### 5. Reference Signal Output Connector

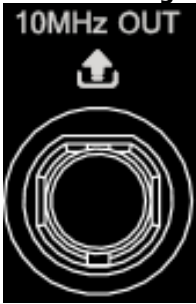

It is used to output the internal 10 MHz reference clock signal used to synchronize the generator with other instruments. For more information about the output clock signal specification of this connector, please refer to *DSG3000B Data Sheet*.

### 6. Reference Signal Input Connector



It is used to input the external 10 MHz reference clock signal which is used to synchronize the generator with other instruments. For more information about the external clock signal specification of this connector, please refer to *DSG3000B Data Sheet*.

## 7. LAN

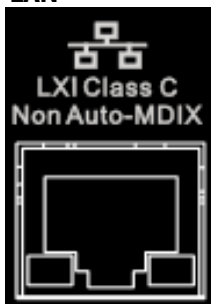

The instrument complies with LXI Device Specification 2011 standard, and supports WebServer, Socket and other remote control modes.

This interface is used to connect the PC or network for remote instrument control.

English

## 8. USB Device



The instrument complies with USBTMC class protocol.

This interface is used to connect to a PC for remote instrument control.

## 9. USB Host



This input is used to connect the USB storage device to update the system, store system states and sweep lists.

## 10. OCXO (option OCXO-B08)



OCXO is an oven-controlled crystal oscillator. It is a frequency reference source with higher temperature stability.

**NOTE:** Forty minutes of warm-up is required for the OCXO to reach its rated frequency. For ordering information of this option, please refer to *DSG3000B Data Sheet*.

## 11. I/Q Modulating Signal In/Out Connectors



When I/Q modulation type is "external", it is used to input the I (In-Phase) baseband signal of I/Q modulation.



When I/Q modulation type is "external", it is used to input the Q (Quadrature Phase) modulating signal of I/Q modulation.



It is used to output the I (In-Phase) components of the I/Q modulation of the built-in baseband generator.



It is used to output the Q (Quadrature Phase) components of the I/Q modulation of the built-in baseband generator.

# To Use DSG3000B for the First Time

## To Connect the Power Supply

Please connect the signal generator to AC power supply using the power cord supplied in the accessories as shown in the figure below. This signal generator supports 100-240 V, 45-440 Hz; 100-240 Vac, 45-65 Hz. The power consumption of the instrument cannot exceed 100 W. When the signal generator is connected to AC power supply via this connector, the instrument selects the correct voltage range automatically and users do not need to select the voltage range manually.

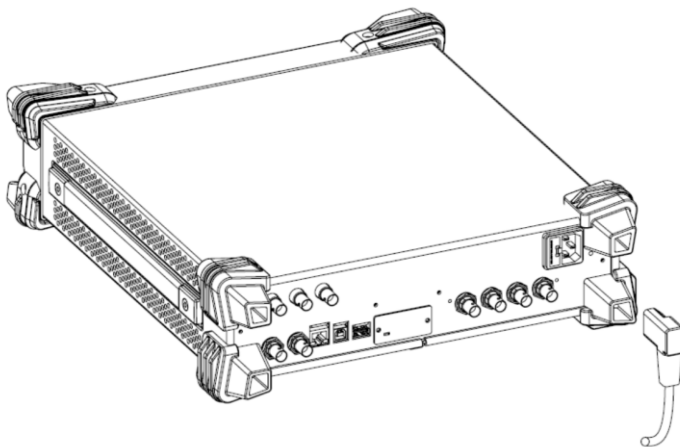



Figure 3 To Connect the Power Supply



### CAUTION

To avoid electric shock, use the standard power cable.

## Turn-on Checkout

After the power supply is correctly connected, press the power key  on the front panel to turn on the signal generator. During the start-up, the instrument performs initialization and self-test. After that, the instrument enters the default interface.

## To Set the System Language

DSG3000B series RF signal generator supports multiple system languages. You can press **System** → **Language** to switch the system language.

# User Interface

The user interface of DSG3000B series RF signal generator provides two display modes: normal display mode and parameter zoom-in mode. At power-on, the instrument enters the normal display mode by default. In this manual, the normal display mode of DSG3136B-IQ is taken as an example to illustrate the user interface of the instrument.

## Normal Display Mode

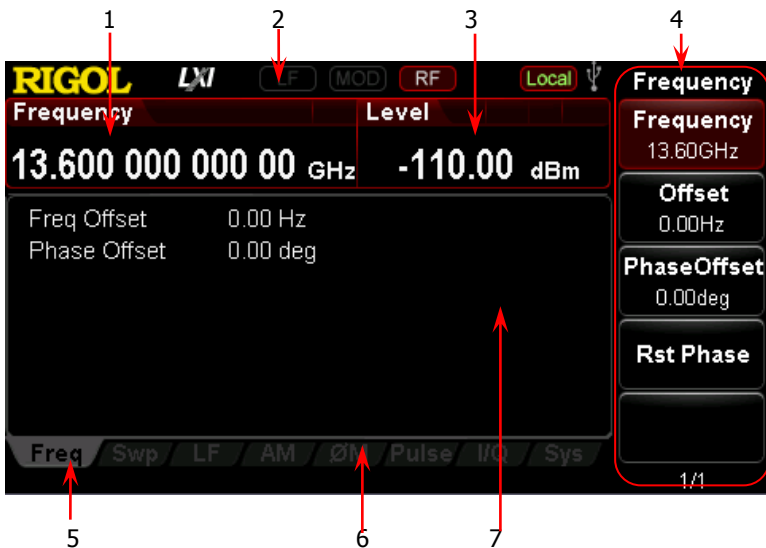







Figure 4 User Interface (Normal Display Mode)

### 1. Frequency Area

Display the current frequency setting of the RF signal generator.





-  : Displayed when the frequency offset is not 0 Hz.
-  : Continuous sweep label. Displayed when the sweep type is "Freq" or "Freq&Lev" and the sweep mode is "Cont".
-  : Single sweep label. Displayed when the sweep type is "Freq" or "Freq&Lev" and the sweep mode is "Single".
-  : Forward sweep label. Displayed when the sweep type is "Freq" or "Freq&Lev" and the sweep direction is "Fwd".

-  : Down sweep label. Displayed when the sweep type is "Freq" or "Freq&Lev" and the sweep direction is "Down".
-  : Frequency sweep progress bar. Displayed when the sweep type is "Freq" or "Freq&Lev".

## 2. Status Bar









Indicate the states of some of the RF signal generator functions.

English

-  : Displayed when the LF output is enabled. This is grayed out when the LF output is disabled.
-  : Displayed when the RF modulation output is enabled. This is grayed out when the RF modulation output is disabled.
-  : Displayed when the RF output is enabled. This is grayed out when the RF output is disabled.
-  : The RF signal generator is operating in remote control mode.
-  : The RF signal generator is operating in local mode.

## 3. Amplitude Area

Display the current level setting of the RF signal generator.

-  : Displayed when the flatness calibration switch is "On".
-  : Displayed when the equal level switch is "On".
-  : Displayed when the amplitude offset is not 0 dB.
-  : Continuous sweep label. Displayed when the sweep type is "Level" or "Freq&Lev" and the sweep mode is "Cont".
-  : Single sweep label. Displayed when the sweep type is "Level" or "Freq&Lev" and the sweep mode is "Single".
-  : Forward sweep label. Displayed when the sweep type is "Level" or "Freq&Lev" and the sweep direction is "Fwd".
-  : Down sweep label. Displayed when the sweep type is "Level" or "Freq&Lev" and the sweep direction is "Down".
-  : Amplitude sweep progress bar. Displayed when the sweep type is "Level" or "Freq&Lev".

## 4. Menu Display Area





The menus in this area correspond to the softkeys at the right of the screen. Pressing any softkey can enable the corresponding menu function.

## 5. Message Display Area

Display the operation error messages and prompt messages. You can press **System** → **Information** → **System Msg** to view the messages. When multiple messages are generated, you can use the up/down arrow keys or knob to select the message row to be viewed. When the messages cannot be displayed completely in the list, press **Verbose** to view the complete information of the current row selected in the message list.

## 6. Function Status Area

Display the current active states of each function. Each function corresponds to at most four kinds of states as shown in the table below.

Type	Remarks	Example
Gray text on a black background	The function is not selected and enabled.	
Black text on a gray background	The function is selected and you can set the corresponding parameters.	
White text on a gray background	The function is selected and enabled.	
White text on a black background	The function is not selected but it is enabled.	

The status labels in the function status area as shown in the figure below.



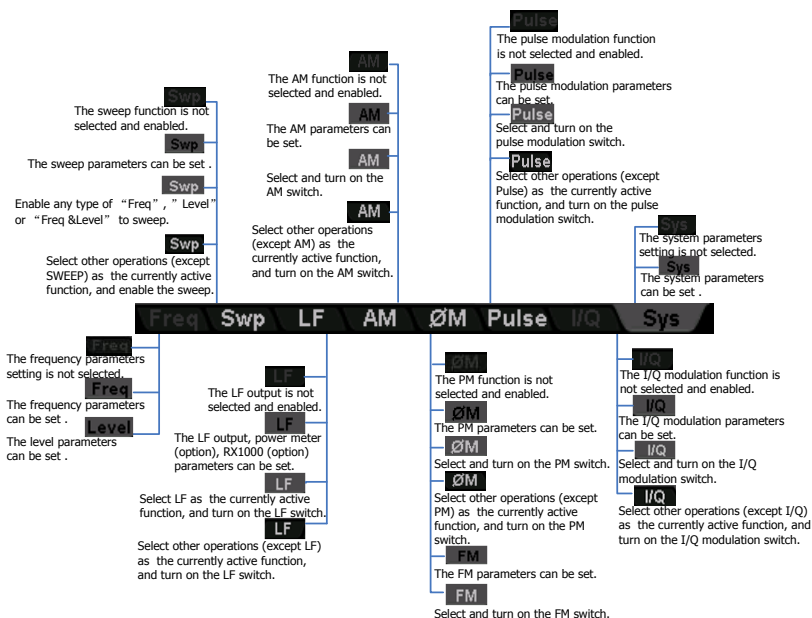

English

Figure 5 Labels in Function Status Area

## 7. Text Display Area

Display the corresponding parameter information of the current function of the RF signal generator.

## Parameter Zoom-in Mode

In normal display mode, pressing the display switch key **View** at the left of the screen can switch to the parameter zoom-in mode as shown in the figure below.

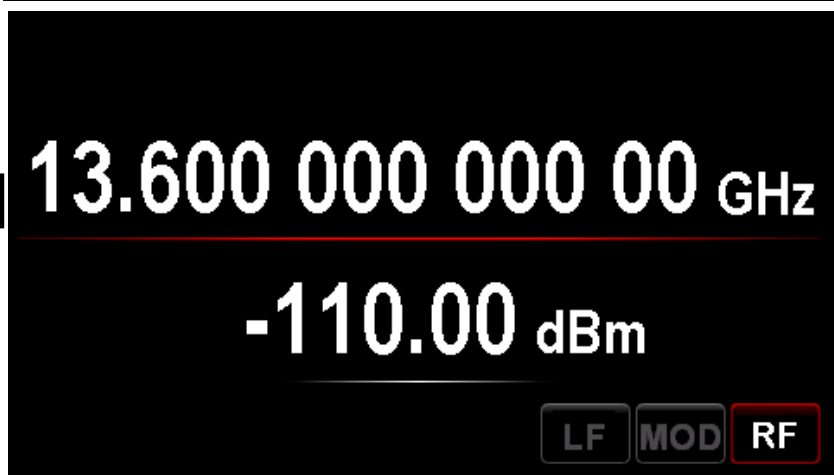

Figure 6 User Interface (Parameter Zoom-in Mode)

## To Replace the Fuse

To replace the fuse, please use the specified fuse and follow the steps below.

1. Turn off the instrument, cut off the power and remove the power cord.
2. Insert a slotted screwdriver into the slot of the fuse holder to pry it out.
3. Take out the fuse.
4. Replace the old fuse with a specified fuse (AC 250 V, T3.15 A).
5. Install the fuse holder.

English

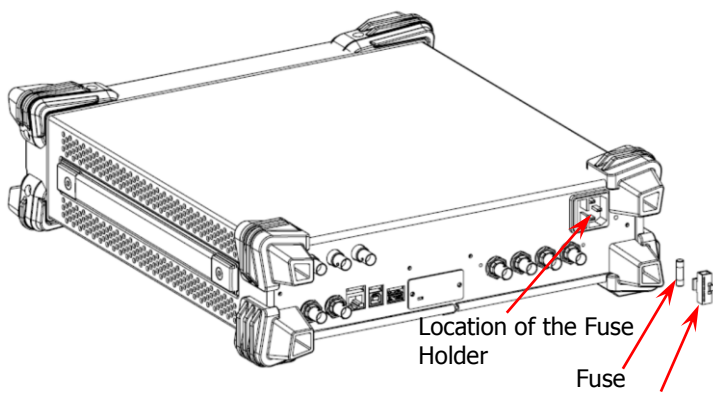

Figure 7 To Replace the Fuse Fuse Holder



### WARNING

To avoid electric shock, make sure that the instrument is turned off, the power supply is disconnected and the fuse used is up to standard before replacing the fuse.

## To Use the Built-in Help System

The DSG3000B built-in help system provides help information for all the function keys and menu softkeys located on the front panel. Users can view the help of any key when operating the instrument.

### 1. Acquire the built-in help

Press **Help** and the prompt message about how to acquire the help

information is displayed in the test display area of the user interface, as shown in Figure 8. Then, press the desired key and the help information of that key is displayed in the text display area.

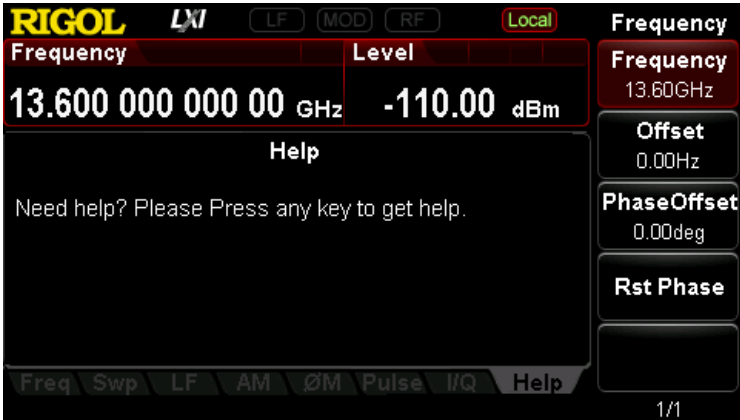

Figure 8 Help Interface

## 2. Page up/down

When the help information is displayed on multiple pages, users can acquire the help information on the previous or next page using the arrow keys or knob.

## 3. Turn off the current help information

When the help information is displayed in the text display area, pressing any key (except the arrow keys and knob) on the front panel will turn off the help information currently displayed.

## 4. Acquire the help information of a menu softkey

Press **Help** and help information is displayed in the text display area. Then, press the desired menu softkey, the help information of the menu item corresponding to this menu softkey is displayed in the text display area.

## 5. Acquire the help information of any function key

Press **Help** and help information is displayed in the text display area. Then, press any function key and the function help information of this key is displayed in the text display area.

# Basic Operations

## To Output RF Signal

Output a RF signal with 1 GHz frequency and -40 dBm amplitude from the [RF OUTPUT 50Ω] connector.

English

### 1. Restore to factory setting

Press **System** → **Reset** → **Preset Type** → "Factory" and then press **Preset** to restore the factory setting (by default, the frequency offset is 0 Hz and the amplitude offset is 0 dB).

### 2. Frequency setting

Press **FREQ** → **Frequency**, use the numeric keyboard to input the frequency value (1) and select the desired unit (GHz) from the pop-up unit menu or unit keys.

- The frequency units available are GHz, MHz, kHz and Hz.
- Pressing **Enter** to select the current frequency unit by default.
- You can also press the Left/Right arrow keys to enter the parameter editing state and move the cursor to the specified digit and then use the Up/Down arrow keys or the knob to modify the value.
- After the frequency is set, you can use the Up/Down arrow keys or the knob to modify the frequency at the current step value.
- Press **FREQ** → **Frequency** and then press **Step** to set the step value.

### 3. Amplitude setting

Press **LEVEL** → **Level**, use the numeric keyboard to input the amplitude value (-40) and select the desired unit (dBm) from the pop-up unit menu or unit keys. You can also press **Enter** to select the default unit dBm.

- The amplitude units available are dBm, -dBm, mV, uV and nV.
- You can also press the Left/Right arrow keys to enter the parameter editing state and move the cursor to the specified digit and then use the Up/Down arrow keys or the knob to modify the value.
- You can also use the Up/Down arrow keys or the knob to modify the amplitude at the current step value.
- Press **LEVEL** → **Level** and then press **Step** to set the step value.

### 4. Enable the RF output

Press **RF**, the backlight lights on and the RF label is displayed in the status

bar of the user interface. The RF output is enabled. At this point, the **[RF OUTPUT 50Ω]** connector outputs RF signal according to the current configuration.



Figure 9 Parameter Setting Interface of RF Signal Output

## To Output RF Sweep Signal

This section introduces how to output a RF sweep signal by configuring continuous linear step sweep. Set the frequency range: 1 GHz to 2 GHz; the amplitude range: -20 dBm to 0 dBm. Set the number of sweep points to 10 and the dwell time to 500 ms.

English

### 1. Restore to factory setting

Press **System** → **Reset** → **Preset Type** → "Factory" and then press **Preset** to restore the factory setting (by default, the sweep mode is continuous, the sweep type is step and the sweep space is linear).

### 2. Step sweep parameter setting

Press **SWEEP** and use the menu page Up/Down key  to turn to the 2/3 menu page; then, press **Step Swp** to enter the step sweep parameter setting interface.

- Start Frequency  
Press **Start Freq**, use the numeric keyboard to input the start frequency value (1) and select the desired unit (GHz) from the pop-up unit menu or unit keys.
- Stop Frequency  
Press **Stop Freq**, use the numeric keyboard to input the stop frequency value (2) and select the desired unit (GHz) from the pop-up unit menu or unit keys.
- Start Level  
Press **Start Lev**, use the numeric keyboard to input the start level value (-20) and select the desired unit (dBm) from the pop-up unit menu or unit keys. You can also press **Enter** to select the default unit (dBm).
- Stop Level  
Press **Stop Lev**, use the numeric keyboard to input the stop level value (0) and select the desired unit (dBm) from the pop-up unit menu or unit keys. You can also press **Enter** to select the default unit (dBm).
- Sweep Points  
Press **Points**, use the numeric keyboard to input the number of

sweep points (10) and then press **OK** or **Enter**.

- Dwell Time

The dwell time indicates the duration of a sweep step.

Press **Dwell Time**, use the numeric keyboard to input the time value (500) and select the desired unit (ms) from the pop-up unit menu or unit keys.

### 3. Enable the RF sweep

Press **SWEEP** → **Sweep** and select "Freq & Level" to enable the frequency and amplitude sweep functions at the same time.

At this point, the RF signal generator sweeps from the start frequency and level to the stop frequency and level continuously at certain step according to the current settings. The frequency and amplitude sweep progress bars as well as the continuous sweep label are displayed in the frequency and amplitude areas in the user interface respectively.

### 4. Enable the RF output

Press **RF**, the backlight lights on and the RF label is displayed in the status bar of the user interface. The RF output is enabled. At this point, the **[RF OUTPUT 50Ω]** connector outputs RF sweep signal according to the current configuration.

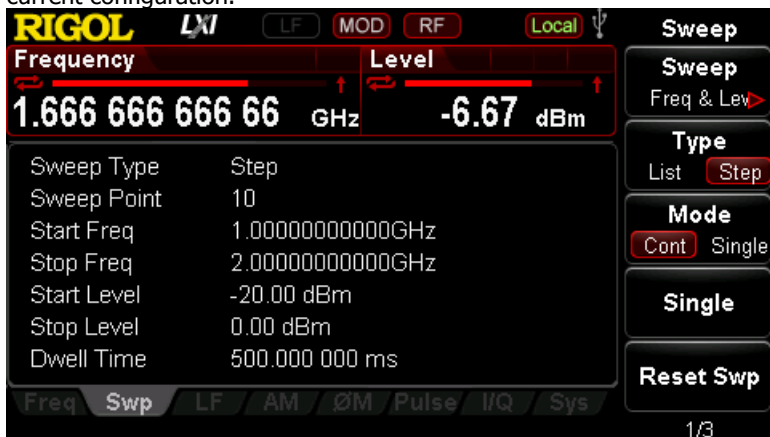

Figure 10 Parameter Setting Interface of RF Sweep Signal Output



## To Output RF Modulated Signal

This section introduces how to output an AM modulated signal. Set the carrier frequency to 800 MHz, the carrier amplitude to -20 dBm, the AM modulation depth to 60% and the modulation frequency to 20 kHz.

English

### 1. Restore to factory setting

Press **System** → **Reset** → **Preset Type** → "Factory" and then press **Preset** to restore the factory setting (by default, the modulation source is internal and the modulation waveform is sine).

### 2. Set the carrier frequency and amplitude

#### (1) Carrier Frequency

Press **FREQ** → **Frequency**, use the numeric keyboard to input the frequency value (800) and select the desired unit (MHz) from the pop-up unit menu or unit keys.

#### (2) Carrier Amplitude

Press **LEVEL** → **Level**, use the numeric keyboard to input the amplitude value (-20) and select the desired unit (dBm) from the pop-up unit menu or unit keys. You can also press **Enter** to select the default unit (dBm).

### 3. Set the AM modulation parameters

(1) Press **AM** to enter the amplitude modulation parameter setting interface.

(2) Press **Depth**, use the numeric keyboard to input the value of the modulation depth (60) and select the desired unit (%) from the pop-up unit menu or by pressing **Enter**.

(3) Press **Freq**, use the numeric keyboard to input the frequency value (20) and select the desired unit (kHz) from the pop-up unit menu or unit keys.

(4) Press **Switch** and select "On" to enable the AM function. The backlight of **AM** lights on.

### 4. Enable the RF modulation output

Press **MOD** and the backlight lights on. Then, press **RF** and the backlight lights on. The MOD and RF labels are displayed in the status bar of the

user interface. The RF modulation output is enabled. At this point, the **[RF OUTPUT 50Ω]** connector outputs RF modulated signal according to the current configuration.

**NOTE:** The backlights of **[RF]** and **[MOD]** should light on.



Figure 11 Parameter Setting Interface of RF Modulated Signal Output

# Remote Control

DSG3000B supports to build communication with the PC via USB, LAN or USB-GPIB interface (option) to realize remote control. The remote control is realized on the basis of the SCPI command set (Standard Commands for Programmable Instruments). This section introduces how to send SCPI commands through the **RIGOL** common PC software Ultra Sigma to control the RF signal generator remotely via the USB interface. For the detailed information of the commands, refer to *DSG3000B Programming Guide*.

English

**Note:** When the instrument is in remote mode, **Rmt** is displayed in the user interface and all the front panel keys (except **Esc**) are locked. At this point, you can press **Esc** to exit the remote mode.

## 1. Install Ultra Sigma

Acquire the Ultra Sigma software and install it as well as its components according to the instructions. You can download the latest version of the software from [www.rigol.com](http://www.rigol.com).

## 2. Control via USB

### (1) Connect the device

Connect the RF signal generator (USB Device) and PC (USB Host) using a USB cable.

### (2) Install USB drive

This RF signal generator is USBTMC device and the **Found New Hardware Wizard** will be displayed after the RF signal generator is correctly connected to the PC (the signal generator will be automatically configured to USB interface) and both of them are started. Please install the "USB Test and Measurement Device" drive program according to the instructions.

### (3) Search for device resource

Start Ultra Sigma and the software will search for the RF signal generator resource currently connected to the PC automatically. You can also click **USB-TMC** to search for the resource manually.

### (4) View the device resource

The resource found together with the instrument model and USB interface information will be displayed under the "RIGOL Online

Resource" directory, as shown in the figure below.

English

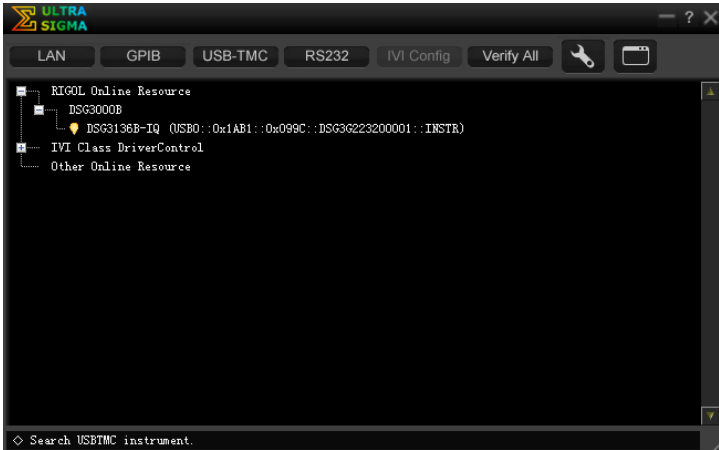

Figure 12 View the USB Device Resource

(5) **Communication test**

Right-click the resource name "DSG3136B-IQ (USB0::0x1AB1::0x099C::DSG3G223200001::INSTR)" and select "SCPI Panel Control" to open the remote command control panel through which you can send commands and read data.

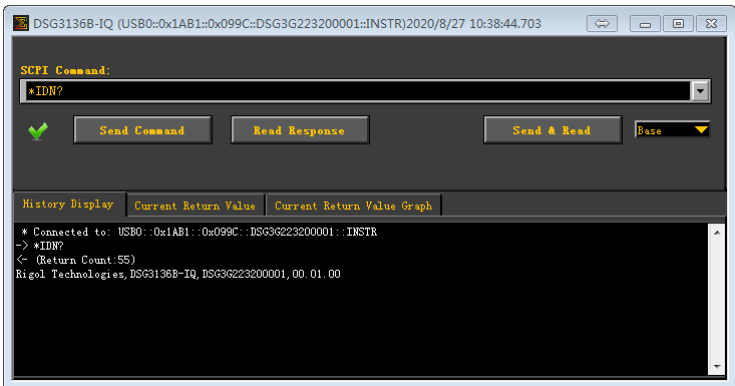

Figure 13 Read and Write Command via USB

# Troubleshooting

The commonly encountered failures and their solutions are listed below. When you encounter those problems, please solve them following the corresponding steps. If the problem remains still, please contact **RIGOL** and provide your device information (**System** → **Information** → **System Info**).

English

## 1. The screen of the RF signal generator is still dark (no display) after pressing the power key.

- (1) Check whether the fan is running;
  - If the fan is running but the screen is dark, the screen connecting wire might be loose.
  - If the fan is not running, the instrument does not start successfully and please go to step (2).
- (2) Check whether the power is correctly connected and the power switch is really on.
- (3) Check whether the fuse is burned out. If the fuse needs to be replaced, please use the specified fuse (AC 250 V, T3.15 A).
- (4) Restart the instrument after finishing the above inspections.
- (5) If it still does not work correctly, please contact **RIGOL**.

## 2. The screen is too dark and cannot be seen clearly.

- (1) Check whether the brightness setting of the LCD screen is too low.
- (2) Press **System** → **Display** → **Brightness** and use the numeric keys or up/down direction keys to adjust the brightness of the LCD screen of the RF signal generator to a proper value.

## 3. The RF signal generator is locked.

- (1) Check whether the RF signal generator is in remote control mode (in remote control, **Rmt** is displayed in the status bar of the user interface). Pressing **Esc** can exit the remote control mode and unlock the front panel.
- (2) Check whether the RF signal generator is in local mode with the screen being locked (when the screen is locked, front panel operations are not available). Pressing **Esc** can unlock the screen and exit the locking state.
- (3) If progress bar is displayed on the screen of the signal generator, some operation is in progress. For example, when saving a file, the progress bar will be displayed indicating that the save operation is in

progress. At this point, the front panel is locked.

- (4) Pressing **Presets** or restarting the signal generator can also unlock the instrument.

#### 4. The setting is correct but the waveform output is incorrect.

- (1) There is no RF output.

- Check whether the signal connecting wire is tightly connected to the corresponding **[RF OUTPUT 50Ω]** connector.
- Check whether the connecting wire has internal damage.
- Check whether the connecting wire is tightly connected to the test instrument.
- Check whether the backlight of **[RF]** goes on. If not, press this key to illuminate the backlight. At this point, the RF label is displayed in the status bar of the user interface and the RF output is enabled.
- Check whether the output amplitude of the RF signal is too small. Adjust the output amplitude properly.

- (2) The RF output is not modulated.

- Check whether the signal connecting wire is tightly connected to the corresponding **[RF OUTPUT 50Ω]** connector.
- Check whether the connecting wire has internal damage.
- Check whether the connecting wire is tightly connected to the test instrument.
- Check whether the backlights of **[MOD]** and **[RF]** are both illuminated and check whether the modulation **Switch** is set to "On".
- Check whether the modulation parameter setting is correct and adjust the parameter appropriately.
- If external modulation source is used, make sure that the external source is correctly connected and outputs signal. At the same time, the external source should work within the specified range of the signal generator.

#### 5. The sweep is abnormal.

- (1) The sweep stagnates

The sweep progress bar is displayed in the frequency area/amplitude area in the user interface indicating that the sweep is in progress. If the sweep stagnates, please check:

- At least one manner of sweep is enabled. Press **[SWEEP]** → **Sweep** to select "Freq", "Level" or "Freq&Level".
- If single sweep mode is selected, press **Single** and the

- instrument performs a sweep if the trigger condition is met.
- If the sweep trigger mode is not set to auto, press **SWEEP** → **Trig** → "Auto" to make sure whether the sweep stagnates due to the loss of sweep trigger.
  - If the point trigger mode is not set to auto, press **SWEEP** → **Point Trig** → "Auto" to make sure whether the sweep stagnates due to the loss of point trigger.
  - Make sure whether the dwell time is too large or too small that the sweep cannot be seen.
  - Make sure that at least two points are set in the step sweep or list sweep.
- (2) The dwell time of list sweep is incorrect
- Press **SWEEP** → **List Swp** to enter the sweep list interface.
  - Make sure whether the dwell time of the list sweep is correct.
  - If the dwell time is incorrect, re-edit it; if it is correct, turn to the next step.
  - Press **SWEEP** → **Sweep Type** to make sure that "List" sweep is selected.  
If "Step" sweep is currently selected, the signal generator sweeps according to the dwell time of the step sweep.
- (3) The list sweep information recalled from the register is lost
- The list sweep information cannot be stored in the status register of the instrument as a part of the instrument state.
  - The signal generator can only use the currently loaded list for sweep.
- (4) In list or step sweep, the amplitude does not change
- Make sure that the sweep manner is set to "Level" or "Freq&Level".
  - If the sweep manner is currently set to "Freq", the amplitude will not change.

## 6. The USB storage device cannot be recognized.

- (1) Check whether the USB storage device can work normally when connected to other instruments or PCs.
- (2) Make sure that the USB storage device used is Flash type. This instrument does not support hardware USB storage device.
- (3) Restart the instrument and insert the USB storage again to check whether it can work normally.
- (4) If the USB storage device still cannot be used normally, please contact **RIGOL**.

**7. No response or incorrect response when key is pressed.**

- (1) After starting the instrument, make sure that whether all the keys are irresponsive.
- (2) Press **System** → **Self-test** → **Key Test** to enter the keyboard test interface. Press the function keys at the front panel sequentially and check whether some key gives no response or incorrect response when it is pressed.
- (3) If the above failures occur, the keyboard connecting wire might be loose or the keyboard is damaged. Please do not disassemble the instrument and contact **RIGOL**.

**8. Performance specification test is not passed.**

- (1) Check whether the RF signal generator is within calibration period (1 year).
- (2) Make sure that the RF signal generator is warmed up for at least 30 minutes before test.
- (3) Check whether the RF signal generator is under the specified temperature.
- (4) Check whether the test is under the magnetic environment.
- (5) Check whether the power supplies of RF signal generator and test system have strong interference.
- (6) Check whether the performance of the test device meets the requirement.
- (7) Make sure that the test device is within calibration period.
- (8) Check whether the test device meets the required conditions of the manual.
- (9) Check whether all connections are tight.
- (10) Check whether all cables have internal damage.
- (11) Make sure that the operations conform to settings and processes which are required by the performance verification manual.
- (12) Check whether the error calculation is a mistake.
- (13) The definitions of "Typical Value" and "Nominal Value" for this product should be correctly understood.
  - Typical Value: the performance specification of this product under specified conditions.
  - Nominal Value: the approximate quantity of the product during application.