

# **RIGOL**

## **快速指南**

### **M300 系列数据采集/开关系统**

2013 年 11 月

**RIGOL Technologies, Inc.**



# 保证和声明

## 版权

© 2013 北京普源精电科技有限公司版权所有。

## 商标信息

**RIGOL** 是北京普源精电科技有限公司的注册商标。

## 文档编号

QGC07005-1110

## 声明

- 公司产品受已获准及尚在审批的中华人民共和国专利的保护。
- 本公司保留改变规格及价格的权利。
- 本手册提供的信息取代以往出版的所有资料。
- 对于本手册可能包含的错误，或因手册所提供的信息及演绎的功能，以及因使用本手册而导致的任何偶然或继发的损失，**RIGOL** 概不负责。
- 未经 **RIGOL** 事先书面许可不得影印复制或改编本手册的任何部分。

## 产品认证

**RIGOL** 认证本产品符合中国国家产品标准和行业产品标准及 ISO9001:2008 标准和 ISO14001:2004 标准，并进一步认证本产品符合其它国际标准组织成员的相关标准。

## 联系我们

如您在使用此产品或本手册的过程中有任何问题或需求，可与 **RIGOL** 联系：

电子邮箱：service@rigol.com

网址：www.rigol.com

# 安全要求

## 一般安全概要

了解下列安全性预防措施，以避免受伤，并防止损坏本产品或与本产品连接的任何产品。为避免可能的危险，请务必按照规定使用本产品。

### 使用正确的电源线。

只允许使用所在国家认可的本产品专用电源线。

### 将产品接地。

本产品通过电源电缆的保护接地线接地。为避免电击，在连接本产品的任何输入或输出端子之前，请确保本产品电源电缆的接地端子与保护接地端可靠连接。

### 正确连接探头。

如果使用探头，探头地线与地电势相同，请勿将地线连接至高电压。

### 查看所有终端额定值。

为避免起火和过大电流的冲击，请查看产品上所有的额定值和标记说明，请在连接产品前查阅产品手册以了解额定值的详细信息。

### 使用合适的过压保护。

确保没有过电压（如由雷电造成的电压）到达该产品。否则操作人员可能有遭受电击的危险。

### 请勿开盖操作。

请勿在仪器机箱打开时运行本产品。

### 请勿将异物插入风扇的排风口。

请勿将异物插入风扇的排风口以免损坏仪器。

### 使用合适的保险丝。

只允许使用本产品指定规格的保险丝。

### 避免电路外露。

电源接通后，请勿接触外露的接头和元件。

### 怀疑产品出故障时，请勿进行操作。

如果您怀疑本产品出现故障，请联络 RIGOL 授权的维修人员进行检测。任何维护、调整或零件更换必须由 RIGOL 授权的维修人员执行。

### 保持适当的通风。

通风不良会引起仪器温度升高，进而引起仪器损坏。使用时应保持良好的通风，定期检查通风口和风扇。

**请勿在潮湿环境下操作。**

为避免仪器内部电路短路或发生电击的危险，请勿在潮湿环境下操作仪器。

**请勿在易燃易爆的环境下操作。**

为避免仪器损坏或人身伤害，请勿在易燃易爆的环境下操作仪器。

**请保持产品表面的清洁和干燥。**

为避免灰尘或空气中的水分影响仪器性能，请保持产品表面的清洁和干燥。

**防静电保护。**

静电会造成仪器损坏，应尽可能在防静电区进行测试。在连接电缆到仪器前，应将其内外导体短暂接地以释放静电。

**正确使用电池。**

如果仪器提供电池，严禁将电池暴露于高温或火中。要让儿童远离电池。不正确地更换电池可能造成爆炸（警告：锂离子电池）。必须使用 **RIGOL** 指定的电池。

**注意搬运安全。**

为避免仪器在搬运过程中滑落，造成仪器面板上的按键、旋钮或接口等部件损坏，请注意搬运安全。

## 安全术语和符号

本手册中的术语。以下术语可能出现在本手册中：

**警告**

警告性声明指出可能会危害操作人员生命安全的条件和行为。

**注意**

注意性声明指出可能导致本产品损坏或数据丢失的条件和行为。

产品上的术语。以下术语可能出现在产品上：

**危险** 表示您如果进行此操作可能会立即对您造成危害。

**警告** 表示您如果进行此操作可能会对您造成潜在的危害。

**注意** 表示您如果进行此操作可能会对本产品或连接到本产品的其他设备造成损坏。

产品上的符号。以下符号可能出现在产品上：



高电压



安全警告



保护性接地端



壳体接地端



测量接地端

## 保养与清洁

### 保养

请勿将仪器放置在长时间受到日照的地方。

### 清洁

请根据使用情况经常对仪器进行清洁。方法如下：

1. 断开电源。
2. 用潮湿但不滴水的软布（可使用柔和的清洁剂或清水）擦试仪器外部的浮尘。清洁带有液晶显示屏的仪器时，请注意不要划伤 LCD 显示屏。



#### 注意

请勿使任何腐蚀性的液体沾到仪器上，以免损坏仪器。

---



#### 警告

重新通电之前，请确认仪器已经干透，避免因水分造成电气短路甚至人身伤害。

---

## 环境注意事项

以下符号表明本产品符合WEEE Directive 2002/96/EC 所制定的要求。



### 设备回收

本产品中包含的某些物质可能会对环境或人体健康有害，为避免将有害物质释放到环境中或危害人体健康，建议采用适当的方法回收本产品，以确保大部分材料可正确地重复使用或回收。有关处理或回收的信息，请与当地权威机构联系。

# 目录

保证和声明 .....	I
安全要求 .....	II
一般安全概要 .....	II
安全术语和符号 .....	III
保养与清洁 .....	IV
环境注意事项 .....	IV
文档概述 .....	1
快速入门 .....	1
一般性检查 .....	1
外观尺寸 .....	2
前面板 .....	3
后面板 .....	6
开机检查 .....	9
用户界面 .....	10
插入式模块概述 .....	11
外观图 .....	11
向主机中插入模块 .....	12
模块简介 .....	13
使用内置帮助系统 .....	15
菜单快速导航 .....	16
Config .....	16
Monitor .....	17
视图切换键 .....	17
Control .....	18
报警通道设置键 .....	18
基本操作 .....	19
测量连接 .....	19
配置扫描列表 .....	23
配置拷贝 .....	25
通道监视 .....	26
远程控制 .....	27
故障处理 .....	29





## 文档概述

本手册概述 M300 系列数据采集/开关系统的前后面板、用户界面及其基本测量的操作方法，旨在指导用户快速熟悉仪器。更多详细的信息，请查阅本产品用户手册。

## 快速入门

本部分概述 M300 系列数据采集/开关系统的前后面板、用户界面以及各插入式模块的基本信息。

## 一般性检查

### 1. 检查运输包装

如运输包装已损坏，请保留被损坏的包装或防震材料，直到货物经过完全检查且仪器通过电性和机械测试。

因运输造成仪器损坏，由发货方和承运方联系赔偿事宜。**RIGOL**公司恕不进行免费维修或更换。

### 2. 检查整机

若存在机械损坏或缺失，或者仪器未通过电性和机械测试，请联系您的 **RIGOL** 经销商。

### 3. 检查随机附件

请根据装箱单检查随机附件，如有损坏或缺失，请联系您的**RIGOL**经销商。

# 外观尺寸



图 1 正视图

单位：毫米 mm

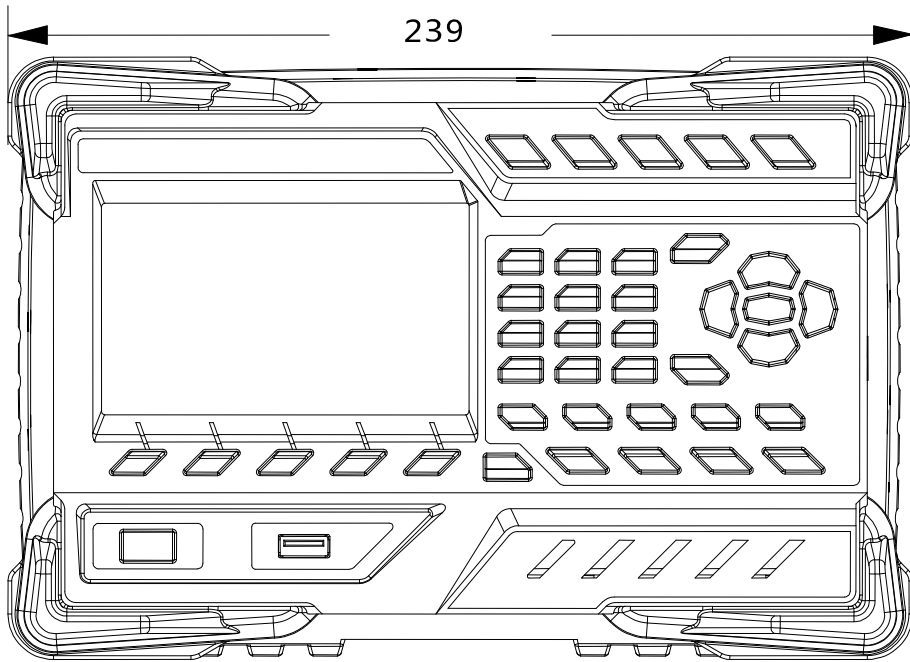

图 2 侧视图

单位：毫米 mm

## 前面板

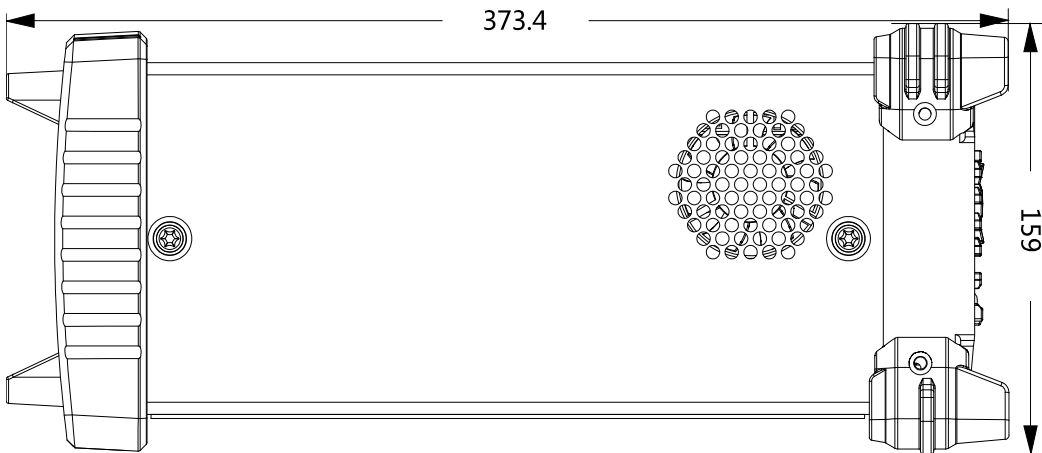

图 3 M300 前面板

### 1. 液晶显示屏

4.3 英寸高清晰彩色液晶显示屏，显示菜单、配置向导、测量参数、系统状态以及提示消息等。

### 2. 功能键

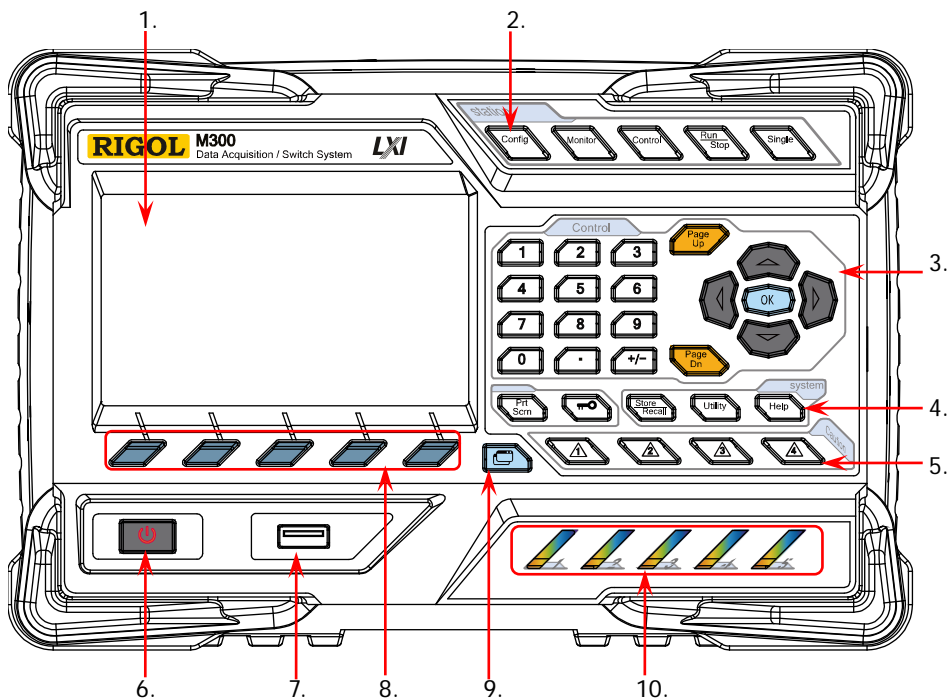

配置扫描列表及各通道的测量参数。

- 创建、编辑、读取、保存扫描列表。
- 设置扫描次数、触发模式和扫描间隔时间。
- 提供通道配置向导，可配置通道的测量参数、定标参数、报警参数和高级测量参数。



开启或关闭通道监视功能。

- 支持单通道、多通道和全通道监视功能。
- 单通道监视功能下，您可以随时变换被监视的通道。
- 多通道监视功能下，您可以监视当前扫描列表中最多7个通道。
- 全通道监视功能下，您可以监视当前扫描列表中的所有通道。



控制当前已插入的模块。

- 控制模块各通道的状态。

- 初始化各模块。
- 配置多功能模块。
- 不可控制 DMM 模块。



自动触发/停止  
按下该按键，仪器开始触发或进入等待触发状态，背灯点亮。此时，长按该按键，仪器停止触发或退出等待触发状态，背灯熄灭。  
**注意：**当前扫描列表为空时，该按键无效。



单通道切换  
仪器处于单通道监视界面时，按下该按键可将被监视的通道切换为扫描列表中的下一通道；仪器处于其它界面时，按下该按键，仪器进入单通道监视界面。

### 3. 控制键

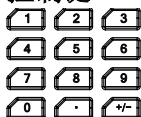

数字键盘

- 提供数字 (0-9)、小数点 (.) 和正负号 (+/-)。
- 用于输入参数值、日期和时间等。



用于打开当前界面的上一页或下一页。  
**注意：**该按键区别于菜单翻页键 (上一頁 或 下一頁)。

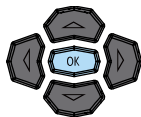

方向键和确认键。

### 4. 系统键



若当前仪器已连接 U 盘，按下该键将屏幕当前内容以 \*.bmp 格式保存到 U 盘中。



- 仪器工作在本地模式时，按下该键锁定前面板。此时，前面板除该键之外的其它按键无效。长按该键解锁前面板。
- 仪器工作在远程模式时，按下该键切换到本地模式。



存储和调用系统配置、测量配置、测量数据等文件。

- 可将文件存储到内部非易失性存储器或外部 U 盘。
- 可读取已存储的文件。



配置系统相关参数。

- 设置时间、日期、系统语言、显示亮度等参数。
- 配置远程接口 (RS232、LAN、GPIB、USB) 参数。
- 查询系统信息 (设备型号、序列号等)。
- 执行自检并查看各模块的信息 (名称、型号等)。
- 系统升级。



打开内置帮助系统。提供前面板各功能按键以及各菜单项的中英文帮助信息。

## 5. 报警通道设置



M300 提供 4 个报警通道。报警产生时，后面板 Alarms/Ext Trig 接口（由 [RS-232/Alarms/Ext Trig] 接口转换而来）对应的引脚产生脉冲输出。按下对应的按键，您可以设置对应引脚的输出方式。

## 6. 电源开关



按下该键可启动或关闭仪器。

## 7. USB Host



通过该接口，M300 可作为主设备，连接 U 盘以存储或调用仪器状态、测量配置、测量数据等文件。

## 8. 菜单软键

与其上方的菜单一一对应。按下任一软键激活对应的菜单。

## 9. 视图切换

查看扫描历史信息、通道状态表、测量曲线和通道信息。

- 扫描历史信息：可查看最近一次扫描的开始时间、扫描圈数、扫描值个数、通道号及其对应的功能、测量的最大值、最小值、平均值、标准偏差以及各通道的扫描读数。
- 通道状态表：显示各通道当前的状态。
- 测量曲线：显示指定通道的测量曲线。
- 通道信息：查看所有模块上各继电器的开关次数、当前扫描的报警信息（各报警通道上的前 100 个，包括报警产生时的读数和时时间）和错误信息（最多 20 个）。

**注意：**每个报警通道上的前 100 个报警信息被存储至报警队列中，之后的报警信息将丢失。错误队列最多可存储前 20 个错误信息，之后的错误信息也将丢失。



## 10. 模块指示灯

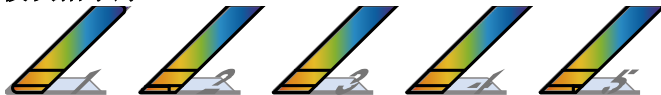

与后面板 5 个槽位一一对应。当后面板的槽位插入模块时，对应的指示灯点亮。

## 后面板



图 4 M300 后面板

### 1. 槽位

M300 提供 5 个槽位，可插入任意 5 个模块。上图中从左到右的 5 个槽位依次与前面板 5 个模块指示灯对应。某一槽位插入模块时，前面板对应的指示灯点亮。图 4 为未插入模块的效果图。欲了解各模块的相关信息，请参考“插入式模块概述”一节。

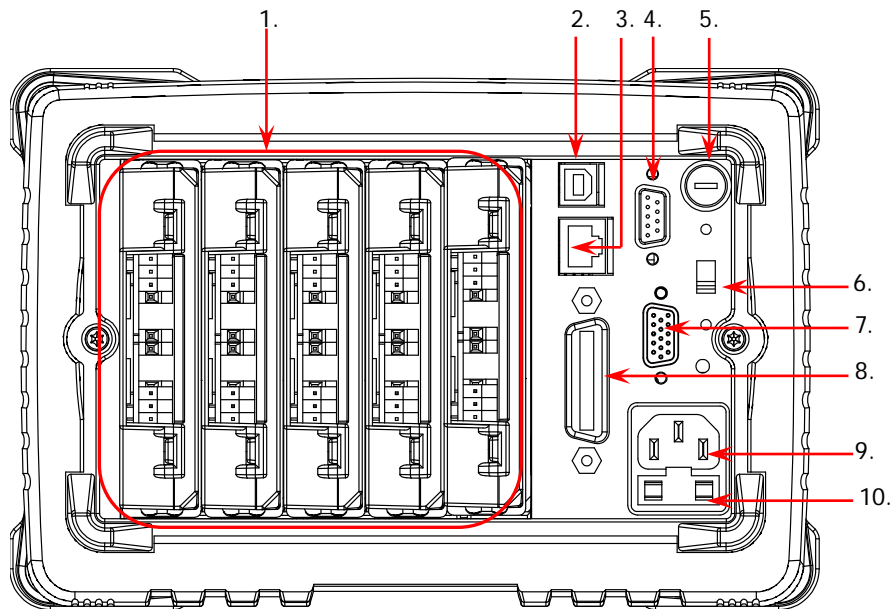

#### 注意

一台主机只允许插入一个 DMM 模块。

### 2. USB Device 接口

通过该接口，M300 作为从设备，可与计算机建立通信。您可以通过计算机远程控制该仪器。

### 3. LAN 接口

M300 符合 LXI Core Device 2011 类仪器标准。通过该接口将仪器连接至网络中，您可以通过位于同一网络中的计算机远程控制该仪器。

### 4. 模拟总线接口 (Female)

M300 提供两个二线内部模拟总线用于信号路由，并提供模拟总线的外部接口（即模拟总线接口）。该接口为 9 针母型接口。

## 5. DMM模块电源保险丝

由电源插口接入的交流电源被分成两路。一路为DMM模块供电，另一路为除DMM模块以外的其它电路供电。M300在此处提供DMM模块电源保险丝（规格为AC 250V T250 mA）。如需更换保险丝，请按照下面的方法进行更换：

- 1) 关闭仪器，拔除电源线。
- 2) 使用一字螺丝刀按下保险丝盖并顺时针旋转。
- 3) 卸下保险丝帽和保险丝。
- 4) 更换指定规格的保险丝，将保险丝帽重新装入。



### 注意

为避免电击或火灾，请使用指定规格的保险丝。

## 6. 电压选择器

M300 支持两种交流电压规格：115 V 和 230 V。请根据您所使用的交流电规格选择正确的电压档位。

## 7. RS-232/Alarms/Ext Trig 混合接口 (Male)

该接口为 25 针公头接口。使用混合接口拆分线（附件）可将该接口转换为 2 个具有 9 引脚的接口。其中，一个为 9 引脚公头，用作标准 RS232 接口；另一个为 9 引脚母头，用于报警输出和外部触发信号输入等。

- RS232: 通过该接口，M300 可与计算机建立通信。您可以通过计算机远程控制该仪器。

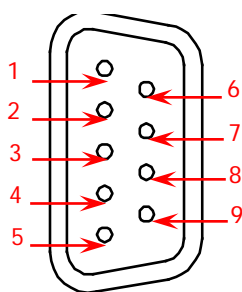

RS232 接口

引脚	名称	定义
1	--	--
2	RXD	接收数据(Received Data)
3	TXD	发送数据(Transmitted Data)
4	DTR	数据终端准备就绪(Data Terminal Ready)
5	SGND	信号地(Signal Ground)
6	DSR	数据准备就绪(Data Set Ready)
7	RTS	请求发送(Request To Send)
8	CTS	清除发送(Clear To Send)
9	--	--

- Alarms/Ext Trig: 如下图所示，引脚 1 至引脚 4 用于在相应报警通道产生报警时输出 TTL 脉冲。引脚 6 用于接收外部触发信号。在连接外部数字万用表进行测量时，引脚 5 和引脚 6 共同用于控制测量。

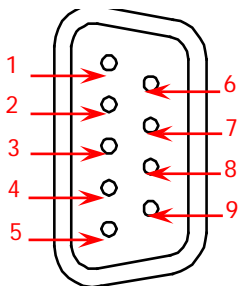

Alarms/Ext Trig 接口

引脚	定义
1	报警通道 1 输出 (Alarm 1 Output)
2	报警通道 2 输出 (Alarm 2 Output)
3	报警通道 3 输出 (Alarm 3 Output)
4	报警通道 4 输出 (Alarm 4 Output)
5	通道关闭输出 (Channel Closed Output)
6	外部触发输入/通道高级输入 (Ext Trig Input/Channel Advance Input)
7	地 (GND)
8	未使用 (Not Used)
9	未使用 (Not Used)

**说明：**每次测量完成时，引脚 5 输出 TTL 负脉冲，脉宽约为  $7\mu\text{s}$ ，输出速度与实际测量速度有关，不超过 1000 次/秒。

外部触发模式下，当引脚 6 接收到脉冲宽度大于或等于  $2\mu\text{s}$  且具有指定边沿（按 **Config** 键，选择“外部”触发模式后，在 **边沿类型** 项中选择“上升沿”或“下降沿”）的外部触发信号时，仪器开始触发。若外部触发信号为连续脉冲，请确保脉冲周期大于  $100\mu\text{s}$ 。

## 8. GPIB 接口

M300 符合 IEEE-488.2 规范。通过该接口，M300 可与计算机建立通信。您可以通过计算机远程控制该仪器。

## 9. 电源插口

M300 可输入两种规格的交流电源。使用附件提供的电源线将交流电通过该插口接入仪器中。



### 注意

连接交流电之前，请先选择正确的电压档位（使用**电压选择器**）。

## 10. 电源保险丝

M300电源保险丝的规格为AC 250V T3.15 A。如需更换，请按照如下步骤操作：

- 1) 关闭仪器，拔除电源线。
- 2) 使用小一字螺丝刀插入电源插口处的凹槽，撬出保险丝座。
- 3) 更换指定规格的保险丝。
- 4) 将保险丝座重新装入卡槽中。



### 注意

为避免电击或火灾，请使用指定规格的保险丝并确保保险丝支架没有短路。



## 开机检查

### 1. 连接电源

- 1) 根据您的供电电压调节仪器后面板的电源电压选择器。M300 支持两种类型的交流电压输入：  
供电电压处于  $115 \times (1-10\%) \text{ V}$  至  $115 \times (1+10\%) \text{ V}$  范围内，请选择 115；  
供电电压处于  $230 \times (1-10\%) \text{ V}$  至  $230 \times (1+10\%) \text{ V}$  范围内，请选择 230。
- 2) 使用附件提供的电源线将仪器连接至交流电源。

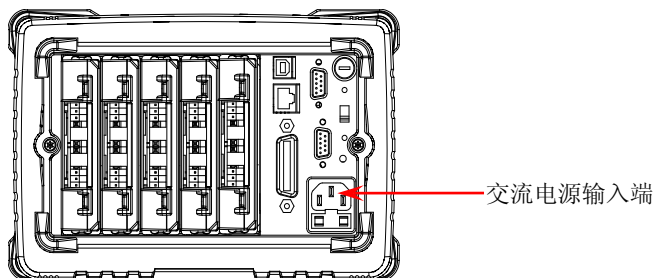

### 2. 启动仪器

按下前面板电源开关。此时，仪器启动。

仪器启动后会检测模块，根据您插入模块数量的不同，此过程可能需要几秒至几十秒的时间，检测过程中 M300 不允许用户操作。

### 3. 若仪器未正常启动，请按照如下步骤进行检查

- 检查电源线是否已正确连接。
- 检查前面板电源开关是否已经打开。
- 拔掉电源线，检查电压选择器是否处于正确的档位，电源输入保险丝是否已经熔断。如果已经熔断，请按要求更换保险丝。
- 做完上述检查后，重新启动仪器。
- 如果故障仍然存在，请与 **RIGOL** 联系。

## 用户界面



图 5 用户界面

### 1. 状态栏

- Help 打开内置帮助时显示。
- Error 产生错误时显示。
-  锁定键盘时显示。
-  产生报警时显示。
-  系统声音关闭时显示。
-  仪器正确连接至网络时显示。
-  仪器检测到 U 盘时显示。
- Local 仪器工作在本地模式时显示。
- Rmt 仪器工作在远程模式时显示。

### 2. 内容栏

显示测量配置向导、测量参数配置等内容，更多信息请参考本产品用户手册。

### 3. 菜单栏

显示当前功能的菜单，与其下方的菜单软键一一对应。按下软键激活相应的菜单。

## 插入式模块概述

M300 提供 DMM 模块、20 通道多路复用器、32 通道多路复用器、64 通道单端多路复用器、多功能模块等共 11 种插入式模块。本节概述 M300 各模块的功能与特点。

### 外观图



图 6 插入式模块外观图

## 向主机中插入模块

向主机中插入模块之前，请首先关闭主机，然后按下述说明进行安装。

如图 6，模块上下各有一条外露的金色电路板边缘。将模块的两条边缘对准主机插槽内的滑槽（如下图箭头所示）后推入，听到“咔嗒”的声音表明已插入到位。此时，接口 2 已与主机连接。

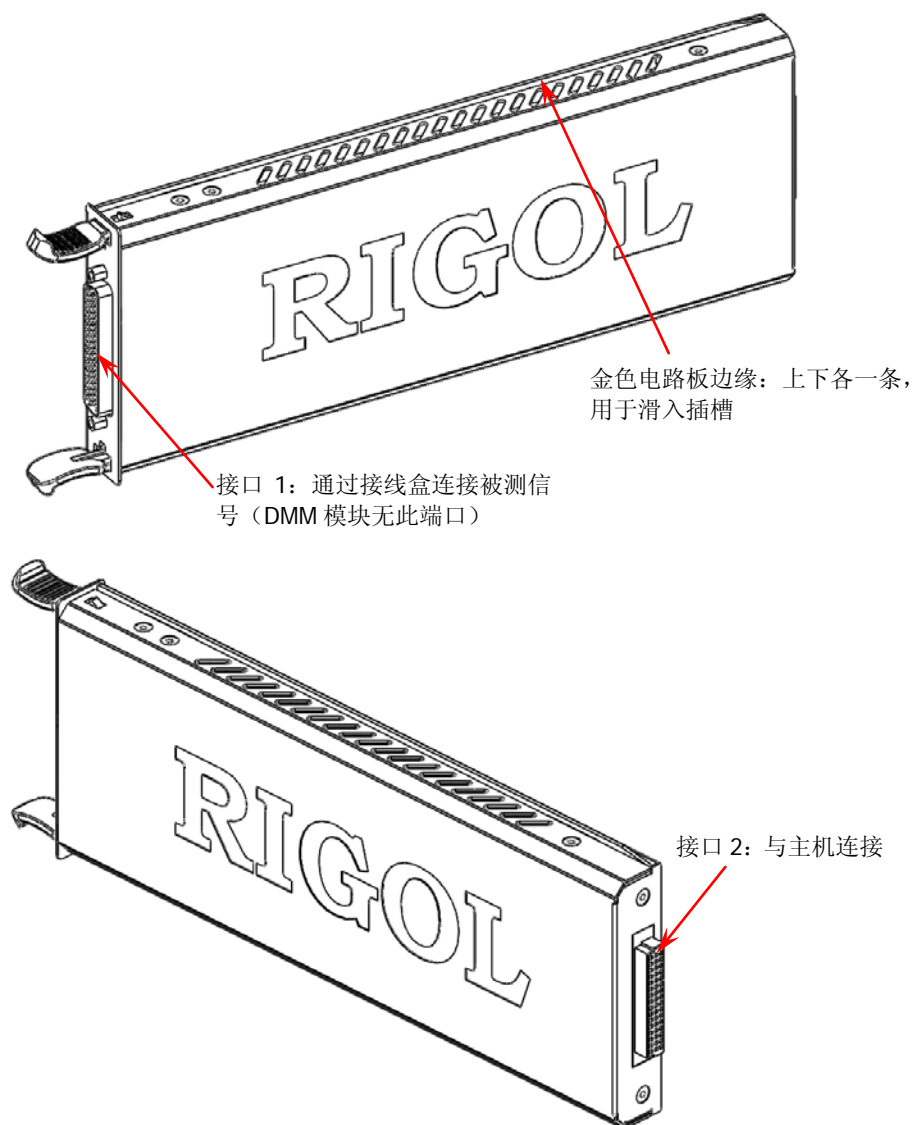
**注意：**对于需要连接被测信号的模块，将之插入主机之前，请先参考“测量连接”一节连接外部接线盒和被测信号。



图 7 向主机中插入模块

**注意：**

M300 的所有模块不支持热插拔。因此，向主机中插入模块之前，请首先关闭主机。

## 模块简介

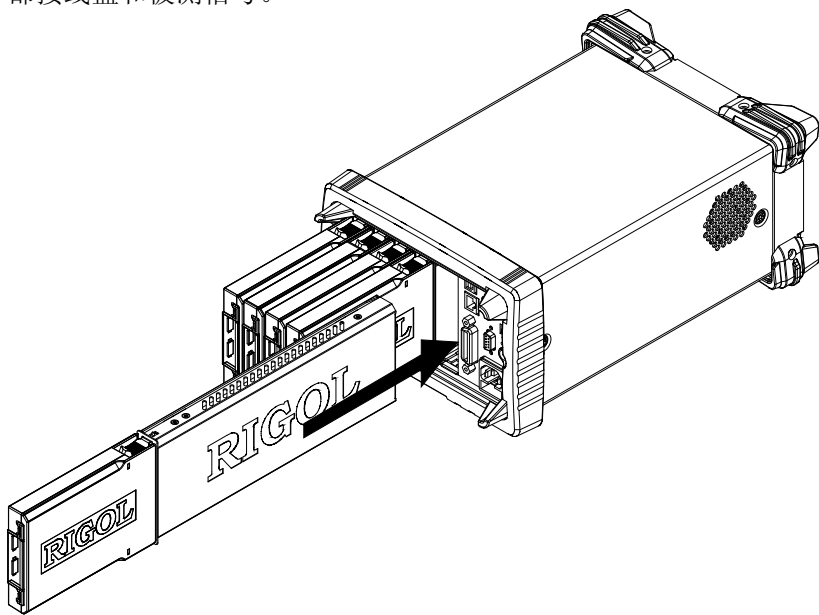
### 1. MC3065 (DMM Module):

DMM 模块用于测量被测信号。6½位读数分辨率。测量功能包括直流电压、交流电压、直流电流、交流电流、二线电阻、四线电阻、频率、周期、温度以及任意传感器。

**注意：**在接入 DMM 模块后，需要确保接入模拟总线的被测信号不高于 300 Vdc 或 300 Vrms。

### 2. MC3120 (20-Channel Multiplexer):

20 通道多路复用器。

20 个通道均可转换 HI 和 LO 输入，从而为 DMM 模块提供完全隔离的信号。MC3120 分为两排（称为 A 和 B），每排具有 10 个双线通道。当执行四线电阻测量时，A 排和 B 排的通道自动配对。所有通道均为先断后通。当任一通道均未被添加在扫描列表时，允许闭合多个通道。可与 MC3065 (DMM Module) 相连（若当前已插入 MC3065）。有关该模块的技术指标，请查阅本产品用户手册或数据手册。

### 3. MC3132 (32-Channel Multiplexer):

32 通道多路复用器。

32 个通道均可转换 HI 和 LO 输入，从而为 DMM 模块提供完全隔离的信号。MC3132 分为两排（称为 A 和 B），每排具有 16 个双线通道。当执行四线电阻测量时，A 排和 B 排的通道自动配对。所有通道均为先断后通。当任一通道均未被添加在扫描列表时，允许闭合多个通道。可与 MC3065 (DMM Module) 相连（若当前已插入 MC3065）。有关该模块的技术指标，请查阅本产品用户手册或数据手册。

### 4. MC3164 (64-Channel Single-Ended Multiplexer):

单端 64 通道多路复用器。

64 个通道均只可转换 HI 输入。MC3164 分为两排（称为 A 和 B），每排具有 32 个单端通道。所有通道均为先断后通。任何情况下均不允许闭合多个通道。可与 MC3065 (DMM Module) 相连（若当前已插入 MC3065）。不可用于四线电阻测量。有关该模块的技术指标，请查阅本产品用户手册或数据手册。

### 5. MC3232 (32-Channel Reed Multiplexer):

干簧 32 通道多路复用器。

MC3232 适用于高速扫描和高通量自动测试的应用。32 个通道均可转换 HI 和 LO 输入，从而为 DMM 模块提供完全隔离的输入。MC3232 分为两排（称为 A 和 B），每排具有 16 个双线通道。当执行四线电阻测量时，A 排和 B 排的通道自动配对。所有通道均为先断后通。当任一通道均未被配置在扫描列表时，允许闭合多个通道。可与 MC3065 (DMM Module) 相连（若当前已插入 MC3065）。有关该模块的技术指标，请查阅本产品用户手册或数据手册。

## 6. MC3264 (64-Channel Single-Ended Reed Multiplexer):

干簧 64 通道单端多路复用器。

MC3264 适用于高速扫描和高通量自动测试的应用。64 个通道均只可转换 HI 输入。MC3264 分为两排（称为 A 和 B），每排具有 32 个单端通道。所有通道均为先断后通。任何情况下均不允许闭合多个通道。可与 MC3065 (DMM Module) 相连（若当前已插入 MC3065）。不可用于四线电阻测量。有关该模块的技术指标，请查阅本产品用户手册或数据手册。

## 7. MC3324 (24-Channel Multiplexer):

20 个电压通道+4 个电流通道混合多路复用器。

20 个电压通道均可转换 HI 和 LO 输入，从而为 DMM 模块提供完全隔离的输入。20 个电压通道分为两排（称为 A 和 B），每排具有 10 个双线通道。当执行四线电阻测量时，A 排和 B 排的通道自动配对。所有通道均为先断后通。当所有通道均未被配置在扫描列表时，允许闭合多个通道。

4 个电流通道用于配合 DMM 模块执行直流电流或交流电流测量功能。所有通道均为先断后通。任何情况下均不允许闭合多个通道。可与 MC3065 (DMM Module) 相连（若当前已插入 MC3065）。有关该模块的技术指标，请查阅本产品用户手册或数据手册。

## 8. MC3416 (16-Channel Actuator):

16 通道执行器。

MC3416 可将信号切换到被测设备或启动外部设备。16 通道中的每一通道可切换至常开（Normally-Open, NO）和常闭（Normally-Closed, NC）状态。有关该模块的技术指标，请查阅本产品用户手册或数据手册。

## 9. MC3534 (Multifunction Module):

多功能模块。

3 种功能，每种功能有 4 个通道。该模块可用于检测状态或控制外部设备，如螺线管、功率继电器、微波开关等。您还可以在扫描过程中读取数字输入以及计数器的计数。

- 4 个 8 位数字输入/输出（digital input/output, DIO）端口
- 4 个计数器（totalizer, TOT）输入端（前 2 个通道为 10 MHz TOT，后 2 个通道为 100 kHz TOT），灵敏度为 1 Vpp
- 4 个模拟输出端，±12 V 已校准电压

有关该模块的技术指标，请查阅本产品用户手册或数据手册。

## 10. MC3648 (4×8 Matrix Switch):

4×8 双线矩阵开关。

MC3648 用于在测试时同时将多台仪器连接到被测设备的多个点上。您可以连接多个矩阵开关的行和列以建立较大的矩阵（如 8×8、4×16，最多 160 个交叉点）。

32 个双线交叉点，可以同时连接任何输入和输出组合。有关该模块的技术指标，

请查阅本产品用户手册或数据手册。

## 11. MC3724 (Dual 4-Channel RF Multiplexers):

双 4 通道射频多路复用器。

MC3724 由两排独立的 4 转 1 多路转换器组成，可转换高频信号或脉冲信号。有关该模块的技术指标，请查阅本产品用户手册或数据手册。

## 使用内置帮助系统

M300 内置帮助系统提供前面板任一按键和菜单的帮助信息。如需获得任何前面板按键或菜单的帮助信息，请首先按下 **Help** 按键将其点亮，用户界面状态栏显示“Help”状态图标，此时，再按下您需要获得帮助的按键或菜单即可。内置帮助界面如下图所示，按 **确定** 退出内置帮助系统。



图 8 内置帮助系统示意图

# 菜单快速导航

本节提供 M300 主要操作菜单的结构图，旨在指导用户快速了解 M300 的操作方法，更多详细信息，请查阅本产品用户手册。

## Config

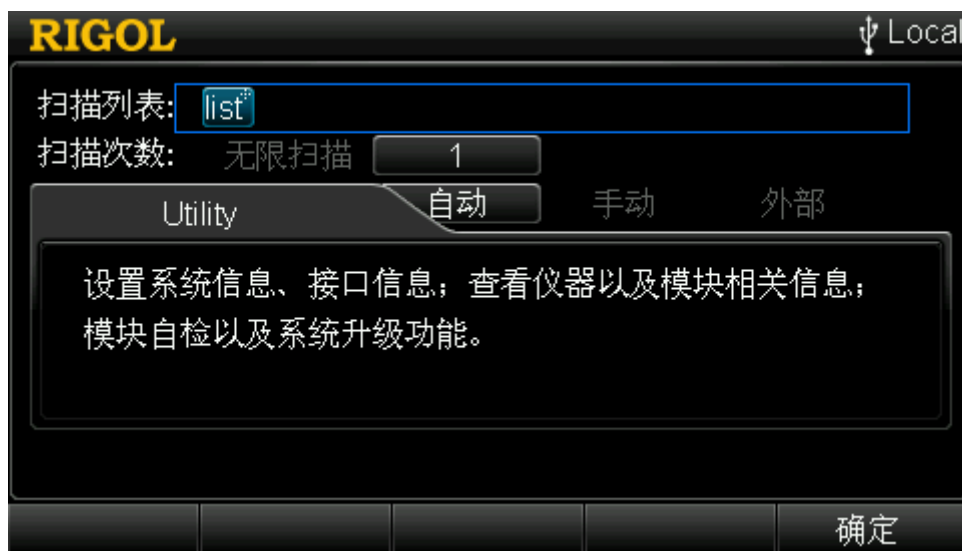
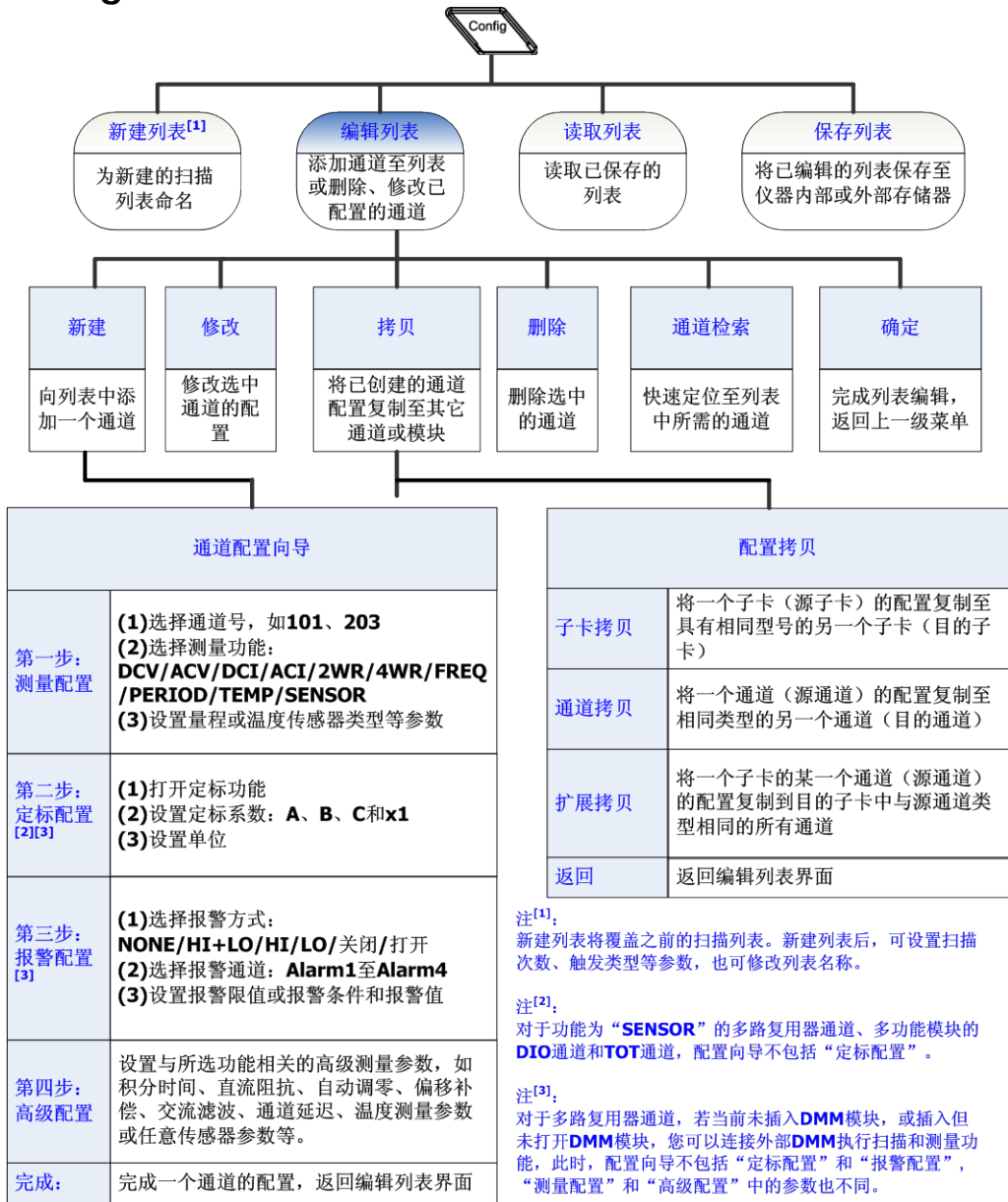



## Monitor

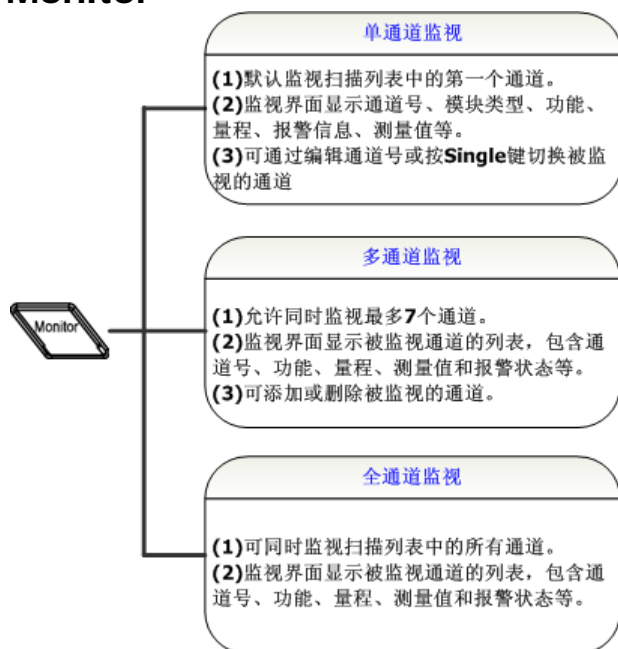

## 视图切换键

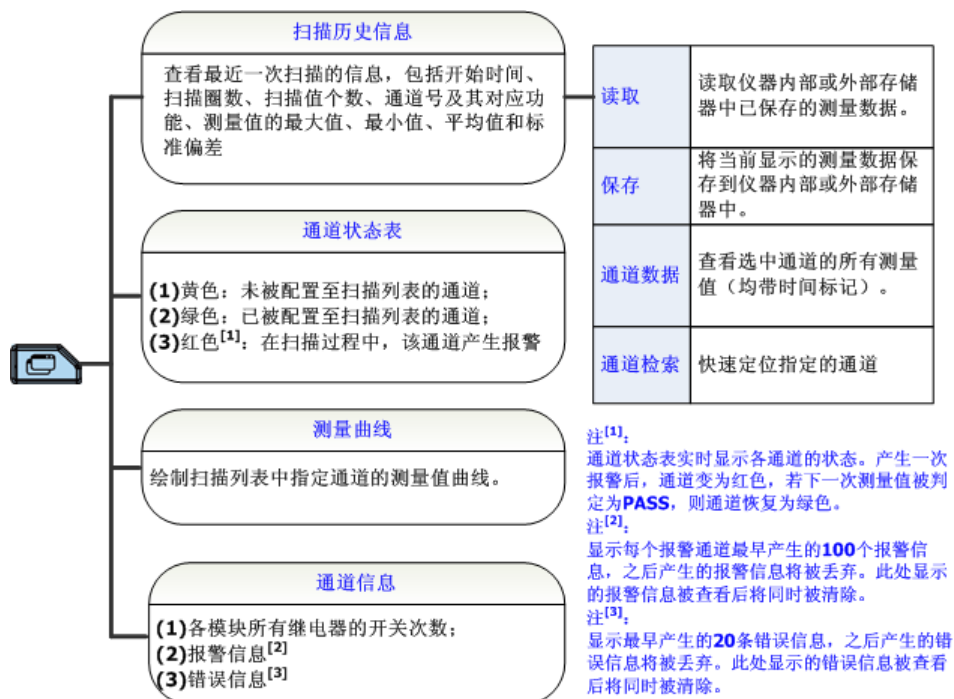

## Control

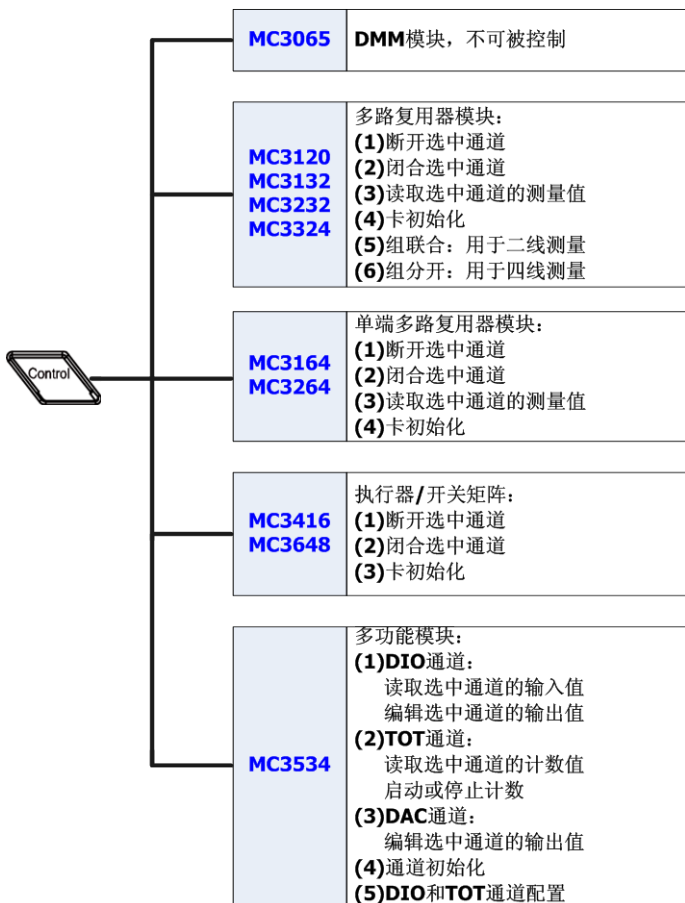

## 报警通道设置键

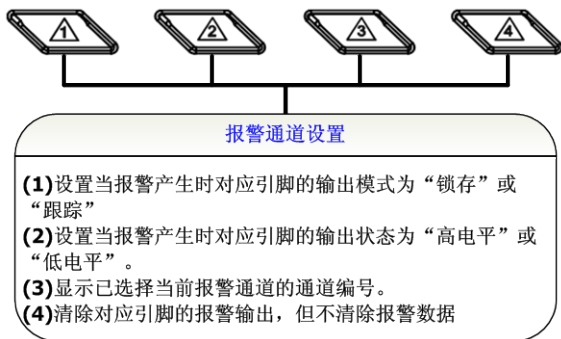

## 基本操作

本部分介绍 M300 的基本操作，包括如何连接被测信号、配置扫描列表、远程控制仪器的方法。

## 测量连接

多个被测信号通过外部接线盒被连接至插入式模块，进而被接入 DMM 模块或外部 DMM。M300 提供 7 种规格的外部接线盒。接线盒的型号及其适用的模块如下表所示。本节介绍如何通过外部接线盒连接被测信号。

表 1 外部接线盒

	外部接线盒型号	适用的模块型号
1.	M3TB20	MC3120
2.	M3TB32	MC3132、MC3232
3.	M3TB64	MC3164、MC3264
4.	M3TB24	MC3324
5.	M3TB48	MC3648
6.	M3TB16	MC3416
7.	M3TB34	MC3534

**注意：**MC3724 无需使用接线盒，可直接将信号连接到模块上的 SMB 连接器。



### 警告

务必断开所有电源后，才可以打开接线盒或使接线盒脱离模块。

1. 将接线盒正面（带有 **RIGOL**）朝下，按下图箭头所示方向同时扳动两个卡勾向下压。将接线盒正面朝上，揭起接线盒上盖后拆掉。

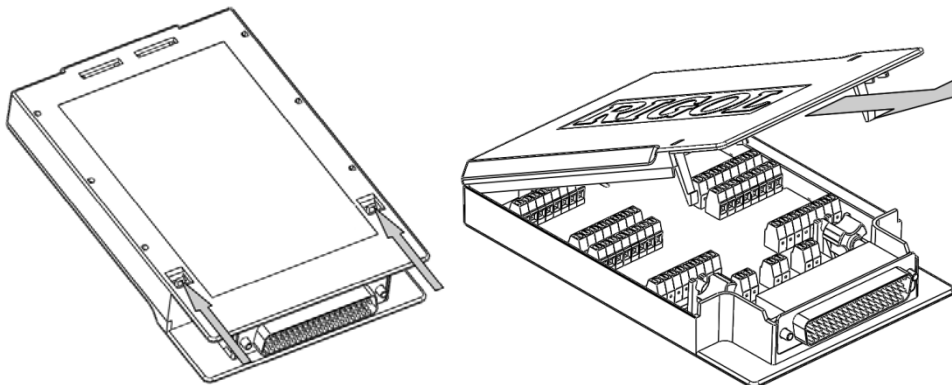

- 按照接线盒电路板上的标识分别连接用于连接被测信号的电缆（连接方式见表 2）。下图中箭头所示的两组孔用于穿过扎线带以固定所连接的电缆。请注意电缆连接的通道或端子以保证接入正确的信号。

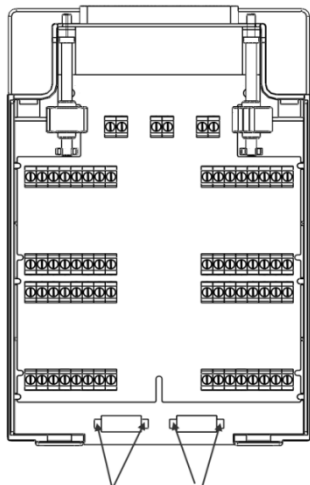

以 M3TB32 为例，接线盒详细布局如下图所示。自左下角至右上角依次分布 32 对接线端子，分别与 MC3132 或 MC3232 的 32 个通道一一对应，可通过接线端子下方或上方的标签 CH01-CH32 识别。下图分别给出二线和四线的连接示意图。



表 2 测量连接

<p><b>DCV/ACV/频率/周期/任意传感器 (DCV、FREQ)</b></p>  <p>H L CH1</p>	<p><b>DCI/ACI/任意传感器 (DCI)</b></p>  <p>H L CH21</p> <p>注：仅适用于 MC3324 的通道 21 至通道 24。</p>
<p><b>2WR/RTD/热敏电阻/任意传感器 (2WR)</b></p>  <p>H L CH1</p>	<p><b>4WR/RTD 4W/任意传感器 (4WR)</b></p>  <p>H L Source CH1</p> <p>H L Sense CH17</p> <p>注：适用于 MC3120、MC3132 和 MC3232 以及 MC3324 的通道 1 至通道 20。</p>
<p><b>热电偶</b></p>  <p>H L CH1</p>	

**警告**

为防止电击，测量电缆需要符合最高耐压要求。为防止损害模块，确保任何输入信号在其所标称的额定输入范围之内。

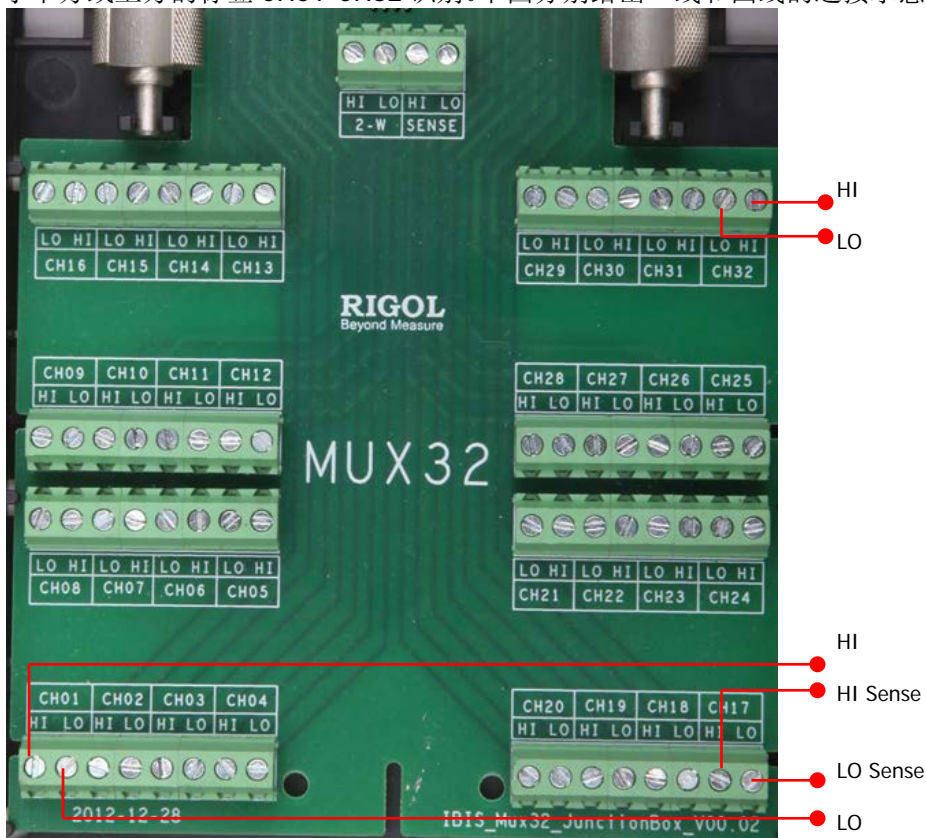
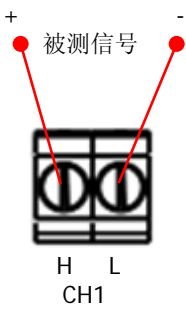
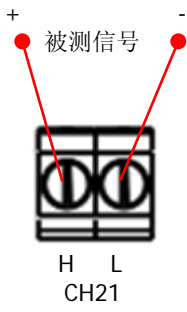
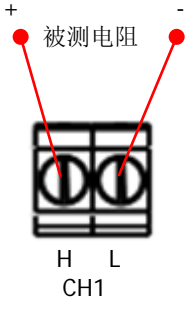
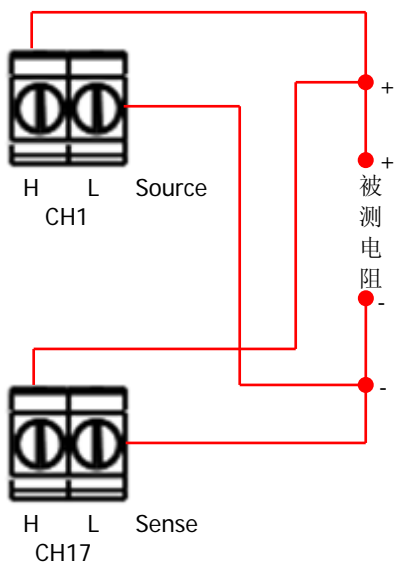
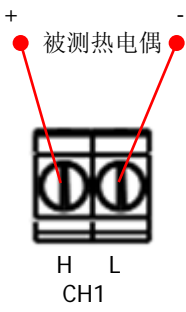
3. 将接线盒与模块上的接口 1（接口定义见图 6）对接，旋紧两个螺杆使之与模块上的螺母紧固。

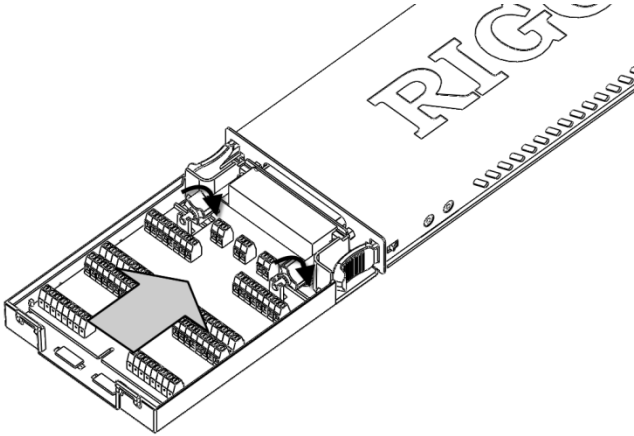

4. 扣上接线盒上盖。

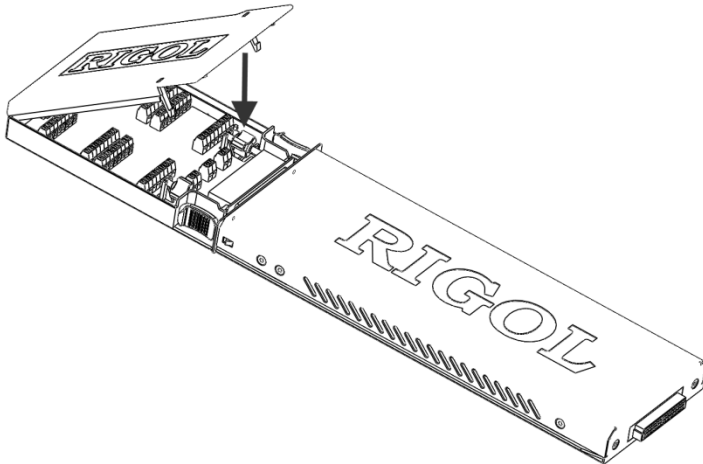

5. 将已连接接线盒的模块插入主机插槽。

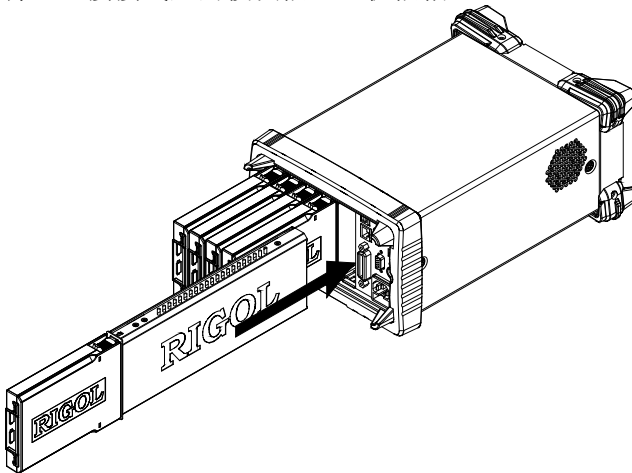

## 配置扫描列表

创建一个扫描列表，将多路复用器的任意通道或多功能模块的 DIO 或 TOT 通道添加到扫描列表，并为每个通道配置基本测量、定标、报警和高级测量参数。编辑完成的扫描列表可以存储至内部或外部存储器，并可在需要使用时调用。

### 1. 新建列表

按 **Config** → **新建列表**，输入所需的列表名称按 **确认** 软键完成命名。

**注意：**新建列表后，原扫描列表将被覆盖。

### 2. 设置扫描参数

- (1) 选中 **扫描次数** 项，使用左右方向键选择“无限扫描”或“1”（需设置一个扫描次数值，可设置范围为 1 至 50000）。
- (2) 选中 **触发模式** 项，使用左右方向键选择“自动”、“手动”、“外部”、“绝对时间”或“报警”。
- (3) 若选择“自动”触发模式，请选中 **间隔时间** 项，使用数字键盘设置所需的间隔时间。可设置范围为 00:00:00.000 至 99:59:59.999（时间格式为小时:分:秒.毫秒），默认为 0。  
若选择“外部”触发模式，请选中 **边沿类型** 项，使用左右方向键选择“上升沿”或“下降沿”。  
若选择“绝对时间”触发模式，请选中 **绝对时间** 项，使用数字键盘设置所需的时间。时间格式为“月-日 时:分:秒”。  
若选择“报警”触发模式，请选中 **报警通道** 项，使用左右方向键选择报警通道为“Alarm1”、“Alarm2”、“Alarm3”或“Alarm4”。

### 3. 配置一个通道至扫描列表（以 DCV 功能为例）

按 **Config** → **编辑列表** → **新建**，进入通道配置向导。

- (1) 第一步：测量配置  
选中 **通道号** 项，使用左右方向键或数字键盘选择所需的通道号（如 101）；  
选中 **测量功能** 项，使用左右方向键选择所需的功能（DCV）；  
选中 **量程** 项，使用左右方向键选择所需的量程（如 2V）。

**注意：**此处需要设置的参数取决于您所选择的测量功能。

- (2) 第二步：定标配置  
选中 **定标配置** 项，使用左右方向键打开定标配置；  
分别选中 **A**、**B** 和 **C**，使用数字键盘设置所需的定标系数；  
选中 **x1**，按 **当前值** 获取 x1。  
选中 **单位** 项，输入所需的单位。

**注意：**对于功能为“SENSOR”的多路复用器通道、多功能模块的 DIO 通道和 TOT 通道，配置向导不包括定标配置。另外，对于多路复用器通道，若当

前未插入 DMM 模块或插入但未打开 DMM 模块，连接外部 DMM 执行扫描和测量时，配置向导也不包括“定标配置”。

(3) 第三步：报警配置

选中 **报警方式** 项，使用左右方向键选择所需的报警方式（如 HI）；

选中 **报警通道** 项，使用左右方向键选择所需的报警通道（如 Alarm1）；

选中 **HI** 或 **LO** 项，使用数字键盘设置所需的报警限值（如 12）；

**注意：**对于多路复用器通道，若当前未插入 DMM 模块或插入但未打开 DMM 模块，连接外部 DMM 执行扫描和测量时，配置向导不包括“报警配置”。

(4) 第四步：高级配置选中 **积分时间** 项，使用左右方向键选择所需的积分时间（如 1PLC）；

选中 **输入阻抗** 项，使用左右方向键选择 10M $\Omega$  或 >10G $\Omega$ ；

选中 **AZ** 项，使用左右方向键选择“打开”或“关闭”；

选中 **延迟** 项，使用左右方向键选择“自动”或手动设置一个延迟时间；

**注意：**此处需要设置的参数取决于您所选择的测量功能。

按 **完成**，通道配置向导结束，返回扫描列表编辑界面。

#### 4. 配置其它通道至扫描列表

按 **新建** 并按照步骤 3 将其它通道配置至扫描列表。

#### 5. 保存扫描列表

扫描列表配置完成后，您可以按 **保存列表** 将已配置的扫描列表保存到仪器内部或外部存储器中。



## 配置拷贝

M300 提供配置拷贝功能（模块拷贝、通道拷贝和扩展拷贝），可用于快速将具有相同配置的通道配置至扫描列表。

按 **Config** → **编辑列表** → **拷贝**，进入配置拷贝界面。

### 1. 模块拷贝：

可将一个模块（源模块）的配置复制至具有相同型号的另一个模块（目的模块）。完成模块拷贝后，源模块各通道的配置情况被自动复制至目的模块。

在配置拷贝界面中，按 **模块拷贝** 软键，打开模块拷贝界面。

(1) 默认选中“源模块”区，使用上下方向键选择所需的源模块。

(2) 按 **切换** 将光标切换至“目的模块”区，使用上下方向键选择所需的目的模块。

(3) 按 **确定** 执行模块拷贝。

**注意：**所选的源模块和目的模块必须具有相同的型号，且不允许对同一模块执行拷贝操作。

### 2. 通道拷贝：

可将一个通道（源通道）的配置复制至相同类型的另一个或多个通道（目的通道）。

在配置拷贝界面中，按 **通道拷贝** 软键，打开通道拷贝界面。默认将所选通道固定为源通道且选中上区域，此时，使用左右方向键选择所需的目的通道，然后按 **OK** 键选中目的通道（再次按 **OK** 键取消选中），按 **完成** 执行通道拷贝。

打开通道拷贝界面后，您也可以按 **切换**，将所选通道固定为目的通道。此时，下区域被选中，使用左右方向键选择所需的源通道，按 **完成** 执行通道拷贝。

#### 提示：

(1) 固定所选通道为源通道时，允许选择多个目的通道。所选的目的通道显示在界面的下区域。

(2) 固定所选通道为目的通道时，只允许选择一个源通道。

(3) 若当前扫描列表仅有一个通道，则 **切换** 置灰禁用。

**注意：**通道拷贝，只允许同一类型通道间的拷贝，即属于同一类型模块的通道。

### 3. 扩展拷贝：

可将一个模块的某一个通道（源通道）的配置复制到目的模块中与源通道类型相同的所有通道。

在配置拷贝界面中，按 **扩展拷贝** 软键，进入扩展拷贝界面。

- (1) 默认选中“源通道”区，使用方向键选择所需的源通道。
- (2) 按 **切换** 将光标切换至“目的模块”区，使用上下方向键选择所需的目的模块。
- (3) 按 **确定** 执行扩展拷贝。

**注意：**扩展拷贝，只允许同一类型模块间的复制。该功能便于配置多个相同的测量通道。

## 通道监视

M300 通道监视功能可监视单通道、扫描列表中的多个通道或全部通道。无论当前是否处于扫描过程中，仪器对通道进行连续监视，不断从被监视通道读取读数。该功能对于在测试前排除系统故障或观测重要信号有极大作用。

通道监视功能可监视如下通道：多路复用器通道（已配置到扫描列表且 DMM 模块已打开）、多功能模块的 DIO 通道和 TOT 通道（无论是否配置到扫描列表，均可监视，且 DMM 模块不必打开）。按前面板 **Monitor** 键，您可以配置通道监视功能。

### 1. 单通道监视

按 **Monitor** → **单通道**，进入单通道监视界面，默认监视扫描列表中的第一个通道。若当前没有配置扫描列表，则监视多功能模块的第 1 个通道（DIO 通道）。单通道监视功能只允许在同一时间监视一个通道。您可以随时更改被监视的通道。监视过程中，仪器仅显示但不存储读数。报警功能应用于被监视通道时，所有报警数据存储在报警队列中（仪器断电时清除数据）。欲监视多路复用器通道，需确保 DMM 模块安装并打开（**Utility** → **DMM** → “开”）且被监视的通道已加入扫描列表。允许监视未加入扫描列表的 DIO 通道和 TOT 通道。

### 2. 多通道监视

按 **Monitor** → **多通道**，进入多通道监视界面。多通道监视允许监视最多 7 个通道。您可以添加或删除被监视的通道。

### 3. 全通道监视

按 **Monitor** → **全通道**，进入全通道监视界面。全通道监视可以监视扫描列表中的所有通道。

## 远程控制

M300 支持通过 USB、LAN、GPIB 或 RS232（由后面板的[RS-232/Alarms/Ext Trig]接口转换）接口与计算机进行通信从而实现远程控制。远程控制基于 SCPI 命令集（Standard Commands for Programmable Instruments）实现。本节将介绍如何使用 RIGOL 提供的通用 PC 软件 Ultra Sigma 发送 SCPI 命令并通过 USB 接口对仪器进行远程控制。有关命令的详细说明请参考本产品编程手册。

### 1. 安装 Ultra Sigma 软件

登陆 RIGOL 网站（www.rigol.com）下载 Ultra Sigma 软件，然后按照指导正确安装。

### 2. 通过 USB 控制

#### (1) 连接设备

使用 USB 数据线连接 M300（USB Device）与计算机（USB Host）。

#### (2) 安装 USB 驱动

本仪器为 USB-TMC 设备，将仪器与 PC 正确连接并开机后，PC 将弹出硬件更新向导对话框，请按照向导的提示安装“USB Test and Measurement Device”驱动程序。

#### (3) 搜索设备资源

打开 Ultra Sigma，软件将自动搜索当前连接到计算机上的仪器资源，您也可以点击 **USB-TMC** 进行搜索。

#### (4) 查看设备资源

搜索到的资源将出现在“RIGOL Online Resource”目录下，并且显示仪器的型号和 USB 接口信息，如下图所示：



图 9 查看 USB 仪器资源

#### (5) 通讯测试

右击资源名“M300 (USB0::0x1AB1::0x0C80::M3001111333::INSTR)”，选

择“SCPI Panel Control”，打开远程命令控制面板，即可通过该面板发送命令和读取数据。

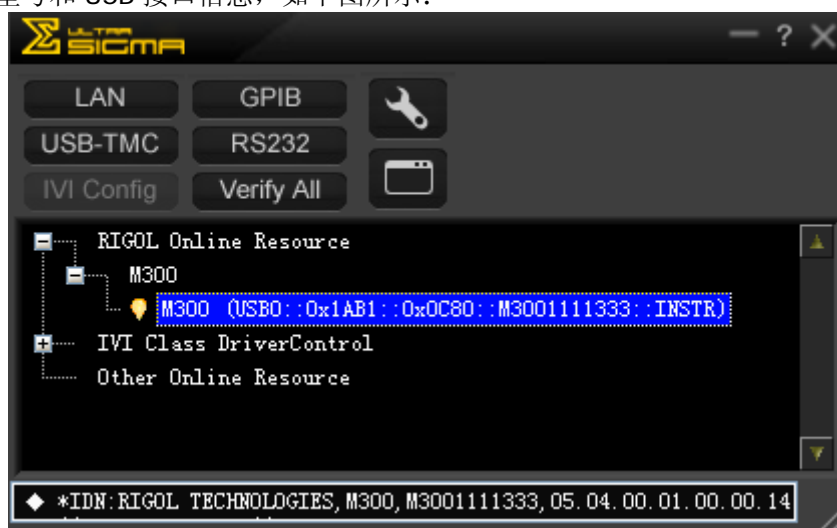



图 10 通过 USB 读写命令

**说明：**

当仪器工作在远程模式时，用户界面状态栏显示 Rmt，前面板按键被锁定（ 除外）。此时，您可以按  键退出远程模式。

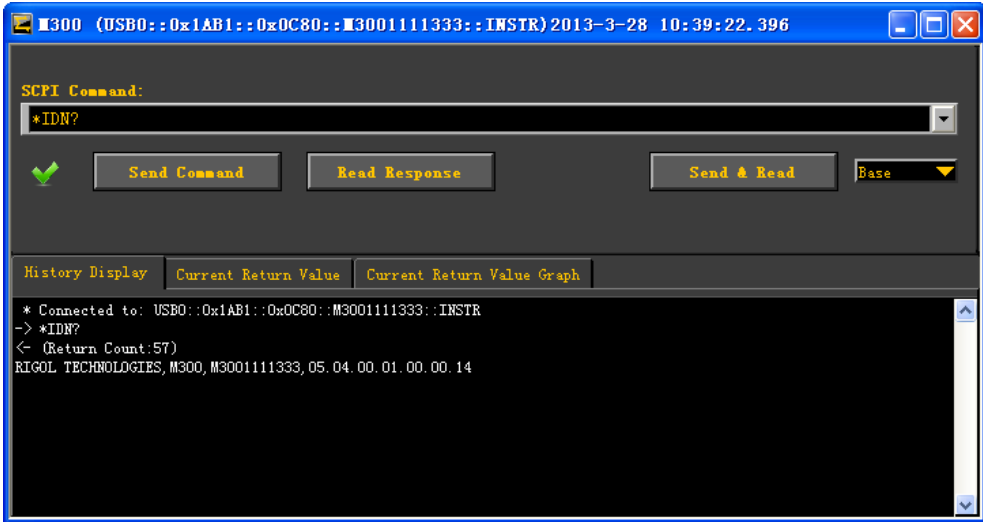
# 故障处理

当您遇到如下问题时，请按照相应的步骤处理。若问题依然存在，请与 **RIGOL** 联系，同时请提供机器的系统信息（获取方法：**Utility** → **信息**）。

## 1 无法开机？

- 1) 检查电源线是否已正确连接。
- 2) 检查前面板电源开关是否已经打开。
- 3) 拔掉电源线，检查电压选择器是否处于正确的档位，电源输入保险丝是否已经熔断。如果已经熔断，请按要求更换保险丝。
- 4) 做完上述检查后，重新启动仪器。
- 5) 如果故障仍然存在，请与 **RIGOL** 联系。

## 2 U 盘不能被识别？

- 1) 检查 U 盘是否可以正常工作。
- 2) 确认使用的为闪存型 U 盘，本仪器不支持硬盘型 U 盘。
- 3) 重新启动仪器，再插入 U 盘进行检查。
- 4) 如果仍然无法正常使用 U 盘，请与 **RIGOL** 联系。



## 3 如果测量过程中发生断电或意外关机，如何恢复断电之前的配置并自动继续关机之前的工作？

重启机器。按 **Utility** → **System**，使用上下方向键选中 **掉电配置** 项，使用左右方向键选择“开”。

## 4 屏幕显示太暗？

按 **Utility** → **System**，使用上下方向键选中 **亮度** 项，使用左右方向键将亮度调整到合适的状态。

## 5 仪器被锁定？

- 1) 检查仪器是否工作在远程模式：仪器工作在远程模式时，用户界面状态栏显示“Rmt”，此时，按  键可退出远程模式，解锁前面板。
- 2) 检查仪器前面板是否被锁定：仪器前面板被锁定时，用户界面状态栏显示 ，此时，长按  键可解锁前面板。
- 3) 检查界面是否显示进度条：等待进度条消失后重试。
- 4) 如果故障仍然存在，重新启动仪器可解除锁定。

## 6 如何切换系统语言？

按 **Utility** → **System**，使用上下方向键选中 **Language** 项，使用左右方向键选择所需的系统语言。

## 7 如何查看插入式模块的信息与型号？

按 **Utility** → **检测**，使用左右方向键选择所需查看的模块，按 **查看** 菜单即可查

看模块的信息与型号。

#### 8 插入模块后，对应插槽的模块指示灯没有点亮？

- 1) 按 **Utility** → **检测**，使用左右方向键选择该模块，按 **重检模块**。
- 2) 若问题依然存在，请按 **查看**。如果无法查看，请参考故障 9 解决；
- 3) 如果可以查看，则判定为模块指示灯损坏，请与 **RIGOL** 联系咨询维修事宜。

#### 9 插入模块后，无法查看模块信息或无法使用该模块？

- 1) 关机，拔掉模块，重新安装模块并确保安装可靠稳定。
- 2) 重启主机，等待 1 分钟，重试查看模块信息。
- 3) 如果故障仍然存在，请与 **RIGOL** 联系。

#### 10 插入 DMM 模块，但是无法执行与 DMM 模块相关的配置或操作？

- 1) 确保 **Utility** → **System** → **DMM** 项的设置为“开”。
- 2) 按 **Utility** → **检测**，使用左右方向键选择 DMM 模块，按 **查看** 菜单查看 DMM 模块信息是否正常。若无显示或不正常显示，则可能由于大电流或电源负载故障导致 DMM 模块工作异常，请关机并等待几分钟后重启。
- 3) 如果故障仍然存在，请与 **RIGOL** 联系。

#### 11 GPIB 接口不能正常工作？

- 1) 检查连接线是否可以正常工作并确保连接正确可靠。
- 2) 确保 M300 的 GPIB 地址与计算机的 GPIB 地址一致。
- 3) 如果故障仍然存在，请与 **RIGOL** 联系。

#### 12 USB Device 接口不能正常工作？

- 1) 检查连接线是否可以正常工作并确保连接正确可靠。
- 2) 检查您的 PC 是否正确安装“USB Test and Measurement Device”驱动程序。
- 3) 如果故障仍然存在，请与 **RIGOL** 联系。

#### 13 RS232 接口不能正常工作？

- 1) 确保仪器与计算机的 RS232 接口参数（波特率等）设置一致。
- 2) 检查 RS232 连接线是否为交叉线。
- 3) 如果故障仍然存在，请与 **RIGOL** 联系。

#### 14 LAN 接口不能正常工作？

- 1) 检查连接线是否可以正常工作并确保连接正确可靠。
- 2) 检查 IP 配置模式：
  - 若 DHCP 打开，请确保当前网络支持 DHCP 配置模式并能够自动为 M300 分配 IP 地址等网络参数；
  - 若 DHCP 关闭，自动 IP 打开，请检查 M300 自动获取的 IP 地址与计算机的网络参数是否处于同一网段；
  - 若仅手动 IP 打开，请确保 M300 与计算机的网络参数设置处于同一网段。
- 3) 如果故障仍然存在，请与 **RIGOL** 联系。

**RIGOL**

**Quick Guide**

**M300 Series  
Data Acquisition/Switch System**

**Nov. 2013  
RIGOL Technologies, Inc.**





# Guaranty and Declaration

## Copyright

© 2013 RIGOL Technologies, Inc. All Rights Reserved.

## Trademark Information

**RIGOL** is a registered trademark of RIGOL Technologies, Inc.

## Publication Number

QGC07105-1110

## Notices

- **RIGOL** products are protected by patent law in and outside of P.R.C.
- **RIGOL** reserves the right to modify or change parts of or all the specifications and pricing policies at company's sole decision.
- Information in this publication replaces all previously corresponding material.
- **RIGOL** shall not be liable for losses caused by either incidental or consequential in connection with the furnishing, use or performance of this manual as well as any information contained.
- Any part of this document is forbidden to be copied or photocopied or rearranged without prior written approval of **RIGOL**.

## Product Certification

**RIGOL** guarantees this product conforms to the national and industrial standards in China as well as the ISO9001:2008 standard and the ISO14001:2004 standard. Other international standard conformance certification is in progress.

## Contact Us

If you have any problem or requirement when using our products or this manual, please contact **RIGOL**.

E-mail: [service@rigol.com](mailto:service@rigol.com)

Website: [www.rigol.com](http://www.rigol.com)

# Safety Requirement

## General Safety Summary

Please review the following safety precautions carefully before putting the instrument into operation so as to avoid any personal injuries or damages to the instrument and any product connected to it. To prevent potential hazards, please use the instrument only specified by this manual.

### **Use Proper Power Cord.**

Only the power cord designed for the instrument and authorized for use within the local country could be used.

### **Ground The Instrument.**

The instrument is grounded through the Protective Earth lead of the power cord. To avoid electric shock, it is essential to connect the earth terminal of power cord to the Protective Earth terminal before any inputs or outputs.

### **Connect the Probe Correctly.**

If a probe is used, do not connect the ground lead to high voltage since it has the isobaric electric potential as ground.

### **Observe All Terminal Ratings.**

To avoid fire or shock hazard, observe all ratings and markers on the instrument and check your manual for more information about ratings before connecting.

### **Use Proper Overvoltage Protection.**

Make sure that no overvoltage (such as that caused by a thunderstorm) can reach the product, or else the operator might expose to danger of electrical shock.

### **Do Not Operate Without Covers.**

Do not operate the instrument with covers or panels removed.

### **Do Not Insert Anything into the Holes of Fan.**

Do not insert anything into the holes of the fan to avoid damaging the instrument.

### **Use Proper Fuse.**

Please use the specified fuses.

### **Avoid Circuit or Wire Exposure.**

Do not touch exposed junctions and components when the unit is powered.

### **Do Not Operate With Suspected Failures.**

If you suspect damage occurs to the instrument, have it inspected by qualified service personnel before further operations. Any maintenance, adjustment or replacement especially to circuits or accessories must be performed by **RIGOL** authorized personnel.

**Keep Well Ventilation.**

Inadequate ventilation may cause increasing of temperature or damages to the device. So please keep well ventilated and inspect the intake and fan regularly.

**Do Not Operate in Wet Conditions.**

In order to avoid short circuiting to the interior of the device or electric shock, please do not operate in a humid environment.

**Do Not Operate in an Explosive Atmosphere.**

In order to avoid damages to the device or personal injuries, it is important to operate the device away from an explosive atmosphere.

**Keep Product Surfaces Clean and Dry.**

To avoid the influence of dust and/or moisture in air, please keep the surface of device clean and dry.

**Electrostatic Prevention.**

Operate in an electrostatic discharge protective area environment to avoid damages induced by static discharges. Always ground both the internal and external conductors of the cable to release static before connecting.

**Proper Use of Battery.**

If a battery is supplied, it must not be exposed to high temperature or in contact with fire. Keep it out of the reach of children. Improper change of battery (note: lithium battery) may cause explosion. Use **RIGOL** specified battery only.

**Handling Safety.**

Please handle with care during transportation to avoid damages to buttons, knob interfaces and other parts on the panels.

## Safety Terms and Symbols

**Terms in this Manual.** These terms may appear in this manual:



---

**WARNING**

Warning statements indicate the conditions or practices that could result in injury or loss of life.

---



---

**CAUTION**

Caution statements indicate the conditions or practices that could result in damage to this product or other property.

---

**Terms on the Product.** These terms may appear on the Product:

**DANGER** indicates an injury or hazard may immediately happen.

**WARNING** indicates an injury or hazard may be accessible potentially.

**CAUTION** indicates a potential damage to the instrument or other property might occur.

**Symbols on the Product.** These symbols may appear on the product:



**Hazardous Voltage**



**Safety Warning**



**Protective Earth Terminal**



**Chassis Ground**



**Test Ground**

## Allgemeine Sicherheits Informationen

Überprüfen Sie die folgenden Sicherheitshinweise sorgfältig um Personenschäden oder Schäden am Gerät und an damit verbundenen weiteren Geräten zu vermeiden. Zur Vermeidung von Gefahren, nutzen Sie bitte das Gerät nur so, wie in diesem Handbuch angegeben.

### **Um Feuer oder Verletzungen zu vermeiden, verwenden Sie ein ordnungsgemäßes Netzkabel.**

Verwenden Sie für dieses Gerät nur das für ihr Land zugelassene und genehmigte Netzkabel.

### **Erden des Gerätes.**

Das Gerät ist durch den Schutzleiter im Netzkabel geerdet. Um Gefahren durch elektrischen Schlag zu vermeiden, ist es unerlässlich, die Erdung durchzuführen. Erst dann dürfen weitere Ein- oder Ausgänge verbunden werden.

### **Anschluss eines Tastkopfes.**

Die Erdungsklemmen der Sonden sind auf dem gleichen Spannungspegel des Instruments geerdet. Schließen Sie die Erdungsklemmen an keine hohe Spannung an.

### **Beachten Sie alle Anschlüsse.**

Zur Vermeidung von Feuer oder Stromschlag, beachten Sie alle Bemerkungen und Markierungen auf dem Instrument. Befolgen Sie die Bedienungsanleitung für weitere Informationen, bevor Sie weitere Anschlüsse an das Instrument legen.

### **Verwenden Sie einen geeigneten Überspannungsschutz.**

Stellen Sie sicher, daß keinerlei Überspannung (wie z.B. durch Gewitter verursacht) das Gerät erreichen kann. Andernfalls besteht für den Anwender die Gefahr eines Stromschlages.

### **Nicht ohne Abdeckung einschalten.**

Betreiben Sie das Gerät nicht mit entfernten Gehäuse-Abdeckungen.

### **Betreiben Sie das Gerät nicht geöffnet.**

Der Betrieb mit offenen oder entfernten Gehäuseteilen ist nicht zulässig. Nichts in entsprechende Öffnungen stecken (Lüfter z.B.)

### **Passende Sicherung verwenden.**

Setzen Sie nur die spezifikationsgemäßen Sicherungen ein.

### **Vermeiden Sie ungeschützte Verbindungen.**

Berühren Sie keine unisolierten Verbindungen oder Baugruppen, während das Gerät in Betrieb ist.

### **Betreiben Sie das Gerät nicht im Fehlerfall.**

Wenn Sie am Gerät einen Defekt vermuten, sorgen Sie dafür, bevor Sie das Gerät wieder betreiben, dass eine Untersuchung durch qualifiziertes Kundendienstpersonal

durchgeführt wird. Jedwede Wartung, Einstellarbeiten oder Austausch von Teilen am Gerät, sowie am Zubehör dürfen nur von **RIGOL** autorisiertem Personal durchgeführt werden.

**Belüftung sicherstellen.**

Unzureichende Belüftung kann zu Temperaturanstiegen und somit zu thermischen Schäden am Gerät führen. Stellen Sie deswegen die Belüftung sicher und kontrollieren regelmäßig Lüfter und Belüftungsöffnungen.

**Nicht in feuchter Umgebung betreiben.**

Zur Vermeidung von Kurzschluß im Geräteinneren und Stromschlag betreiben Sie das Gerät bitte niemals in feuchter Umgebung.

**Nicht in explosiver Atmosphäre betreiben.**

Zur Vermeidung von Personen- und Sachschäden ist es unumgänglich, das Gerät ausschließlich fernab jedweder explosiven Atmosphäre zu betreiben.

**Geräteoberflächen sauber und trocken halten.**

Um den Einfluß von Staub und Feuchtigkeit aus der Luft auszuschließen, halten Sie bitte die Geräteoberflächen sauber und trocken.

**Schutz gegen elektrostatische Entladung (ESD).**

Sorgen Sie für eine elektrostatisch geschützte Umgebung, um somit Schäden und Funktionsstörungen durch ESD zu vermeiden. Erden Sie vor dem Anschluß immer Innen- und Außenleiter der Verbindungsleitung, um statische Aufladung zu entladen.

**Die richtige Verwendung des Akkus.**

Wenn eine Batterie verwendet wird, vermeiden Sie hohe Temperaturen bzw. Feuer ausgesetzt werden. Bewahren Sie es außerhalb der Reichweite von Kindern auf. Unsachgemäße Änderung der Batterie (Anmerkung: Lithium-Batterie) kann zu einer Explosion führen. Verwenden Sie nur von RIGOL angegebene Akkus.

**Sicherer Transport.**

Transportieren Sie das Gerät sorgfältig (Verpackung!), um Schäden an Bedienelementen, Anschlüssen und anderen Teilen zu vermeiden.

## Sicherheits Begriffe und Symbole

Begriffe in diesem Guide. Diese Begriffe können in diesem Handbuch auftauchen:



### WARNING

Die Kennzeichnung WARNING beschreibt Gefahrenquellen die leibliche Schäden oder den Tod von Personen zur Folge haben können.



### CAUTION

Die Kennzeichnung Caution (Vorsicht) beschreibt Gefahrenquellen die Schäden am Gerät hervorrufen können.

Begriffe auf dem Produkt. Diese Bedingungen können auf dem Produkt erscheinen:

**DANGER** weist auf eine Verletzung oder Gefährdung hin, die sofort geschehen kann.

**WARNING** weist auf eine Verletzung oder Gefährdung hin, die möglicherweise nicht sofort geschehen.

**CAUTION** bedeutet, dass eine mögliche Beschädigung des Instruments oder anderer Gegenstände auftreten kann.

Symbole auf dem Produkt. Diese Symbole können auf dem Produkt erscheinen:



Gefährliche  
Spannung



Sicherheits-  
Hinweis



Schutz-erde



Gehäusemasse



Erde

## General Care and Cleaning

### General Care:

Do not store or leave the instrument in where the instrument will be exposed to direct sunlight for long periods of time.

### Cleaning:

Clean the instrument regularly according to its operating conditions. To clean the exterior surface, perform the following steps:

1. Disconnect the instrument from all power sources.
2. Clean the loose dust on the outside of the instrument with a lint- free cloth (with a mild detergent or water). When cleaning the LCD, take care to avoid scarifying it.



### CAUTION

To avoid damages to the instrument, do not expose them to liquids which have causticity.

---



### WARNING

To avoid injury resulting from short circuit, make sure the instrument is completely dry before reconnecting to a power source.

---

## Environmental Considerations

The following symbol indicates that this product complies with the applicable WEEE Directive 2002/96/EC.



### Product End-of-Life Handling

The equipment may contain substances that could be harmful to the environment or human health. In order to avoid release of such substances into the environment and harm to human health, we encourage you to recycle this product in an appropriate system that will ensure that most of the materials are reused or recycled appropriately. Please contact your local authorities for disposal or recycling information.



# Content

<b>Guaranty and Declaration .....</b>	<b>I</b>
<b>Safety Requirement .....</b>	<b>II</b>
General Safety Summary.....	II
Safety Terms and Symbols .....	IV
Allgemeine Sicherheits Informationen .....	V
Sicherheits Begriffe und Symbole.....	VII
General Care and Cleaning.....	VIII
Environmental Considerations.....	VIII
<b>Document Overview.....</b>	<b>1</b>
<b>Quick Start .....</b>	<b>1</b>
General Inspection .....	1
Appearance and Dimensions .....	2
Front Panel .....	3
Rear Panel .....	7
Power On and Inspection.....	10
User Interface.....	11
Plug-in Module Overview.....	12
Outside View drawing of the module .....	12
Insert the Module into the Mainframe.....	13
Module Overview .....	14
To Use the Built-in Help System.....	16
Menu Quick Navigation .....	17
Config.....	17
Monitor .....	18
View Switch Key .....	18
Control.....	19
Alarm Channel Setting Keys.....	19
<b>Basic Operations .....</b>	<b>20</b>
Measurement Connections .....	20
To Configure Scan List .....	24
Configuration Copy.....	26
Channel Monitor.....	27
Remote Control .....	28
<b>Troubleshooting .....</b>	<b>30</b>



---

# Document Overview

This manual introduces the front and rear panels, the user interface and the basic measurement method of M300 Series Data Acquisition/Switch System briefly and guides users to be familiar with the instrument quickly. For more detailed information, please refer to the User's Guide.

## Quick Start

This section provides the basic information about the front and rear panels, the user interface and the plug-in modules.

## General Inspection

### 1. Inspect the shipping container for damage

Keep the damaged shipping container or cushioning material until the contents of the shipment have been checked for completeness and the instrument has passed both electrical and mechanical tests.

The consigner or carrier shall be liable for the damage to instrument resulting from shipment. **RIGOL** would not be responsible for free maintenance/rework or replacement of the unit.

### 2. Inspect the instrument

In case of any damage, or defect, or failure, notify your **RIGOL** sales representative.

### 3. Check the accessories

Please check the accessories according to the packing lists. If the accessories are incomplete or damaged, please contact your **RIGOL** sales representative.

# Appearance and Dimensions

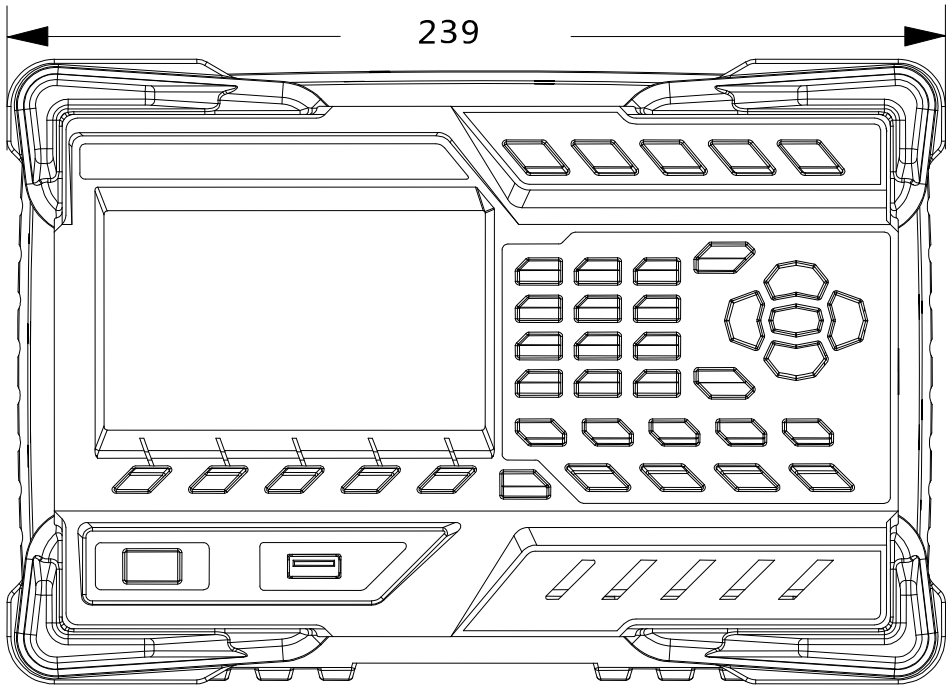

Figure 1 Front View (Unit: mm)

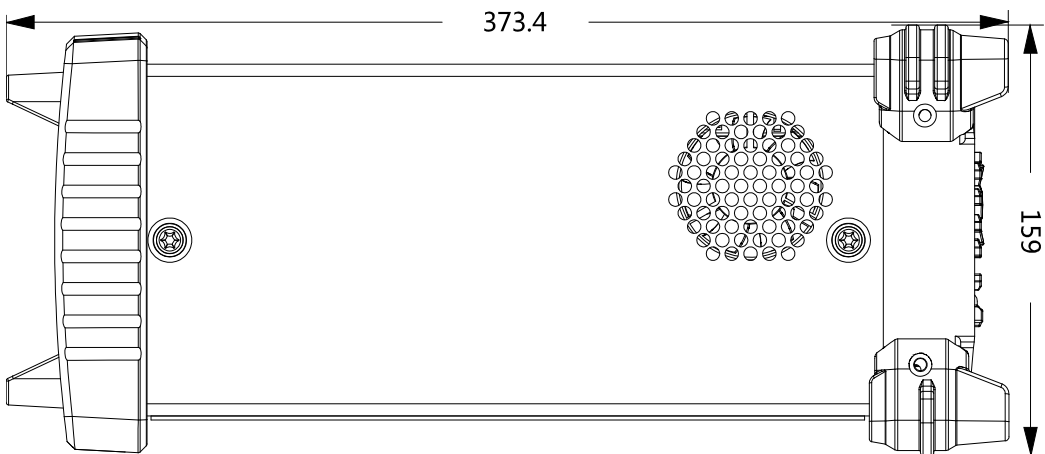

Figure 2 Side View (Unit: mm)

## Front Panel

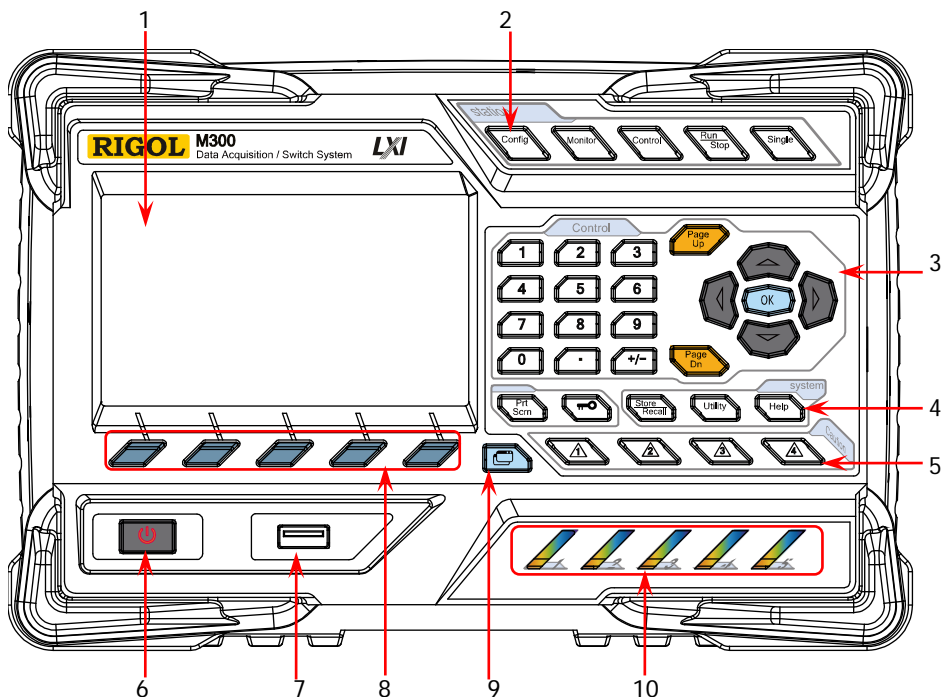

Figure 3 Front Panel

### 1. LCD

4.3 inches high-resolution color LCD displaying the menu, configuration guide, measurement parameters, system status, prompt messages, etc.

### 2. Function Keys



Configure the scan list and the measurement parameters of each channel.

- Create, edit, read and save the scan list.
- Set the number of scans, trigger mode and scan interval.
- Provide the channel configuration guide which can be used to configure the measurement parameters, scaling parameters, alarm parameters and advanced measurement parameters of the channel.



Enable or disable the channel monitor function.

- Support single-channel, multi-channel and all-channel monitor functions.
- In single-channel monitor function, you can switch the channel monitored at any time.
- In multi-channel monitor function, you can monitor up to 7 channels in the scan list.

- In all-channel monitor function, you can monitor all the channels in the scan list.



Control the modules currently inserted.

- Control the status of each channel of the modules.
- Reset the modules.
- Configure the channels of multifunction module.
- Can not control the DMM module.



Auto Trigger/Stop

Press this key, the instrument triggers or enters the wait-for-trigger state and the backlight goes on; at this point, press and hold this key, the instrument stops triggering or exits the wait-for-trigger state and the backlight goes off.

**Note:** this key is invalid when the scan list is empty.



Single-channel Switch

When the instrument is in the single-channel monitor interface, press this key to switch the channel monitored to the next channel in the scan list; when the instrument is in other interfaces, press this key to switch the instrument to the single-channel monitor interface.

### 3. Control Keys

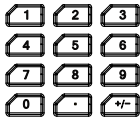

#### Numeric Keyboard

- Include numbers (0-9), decimal point (.) as well as positive/negative signs (+/-).
- Used to input parameter value, date and time.



Use this key to open the previous or next page of the current interface.

**Note:** these keys are different from the menu page up/down keys (**Page Up** and **Page Dn**).

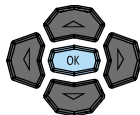

Direction keys and confirmation key.

### 4. System Keys



If a USB storage device is currently connected to the instrument, press this key to store the current content on the screen in USB storage device in \*.bmp format.



- When the instrument is in local mode, pressing this key can lock the front panel. At this point, all the keys at the front panel except this key become invalid. Press and hold this key to unlock the front panel.

- When the instrument is in remote mode, press this key to switch to local mode.



Store and recall the system configuration, measurement configuration and measurement data, etc.

- Store the file in the internal non-volatile memory or external USB storage device.
- Read the file stored.



Configure the system-related parameters.

- Set various parameters such as the time, date, system language and display brightness.
- Configure the remote interface (RS232, LAN, GPIB and USB) parameters.
- Query the system information (such as the model and serial number).
- Execute self-test and view the information of each module (such as the name and model of the module).
- System update.



Enable the built-in help system. Provide Chinese/English help information for the front panel function keys and menu items.

## 5. Alarm Channel Setting



M300 provides 4 alarm channels. When an alarm is generated, the corresponding pin of the Alarms/Ext Trig interface (converted from the **[RS-232/Alarms/Ext Trig]** interface) at the rear panel outputs a pulse. You can press the corresponding key to set the output mode of the corresponding pin.

## 6. Power Key



Press this key to turn on or off the instrument.

## 7. USB Host



Via this interface, M300 can be as a host device and connected with an USB storage device to store or recall instrument status, measurement configuration, measurement data, etc.

## 8. Menu Softkeys

Correspond to the menus on the screen. Pressing any softkey can enable the corresponding menu.

## 9. View Switch

View the scan history information, channel status table, measurement curve and channel information.



- Scan history information: view the start time, scan sweep, count, channel number as well as the corresponding function, maximum, minimum, average and standard deviation measured and the scan readings of each channel of the latest scan.
- Channel status table: display the current status of each channel.
- Measurement curve: display the measurement curve of the specified channel.
- Channel information: view the cycle count of each relay of the module, the alarm messages of the current scan (the first 100 on each alarm channel, including the reading and time when the alarm is generated) and error messages (up to 20).

**Note:** up to 100 alarm messages on each alarm channel can be logged in the alarm queue and the other alarm messages would be lost and up to 20 error messages can be logged in the error queue and the other error messages will also be lost.

## 10. Module Indicators

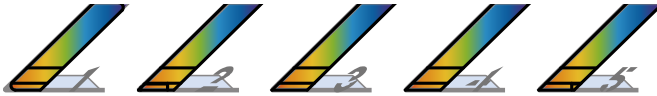

Correspond to the 5 module slots at the rear panel respectively. The corresponding module indicator goes on when the module is inserted into the slot at the rear panel.



## Rear Panel

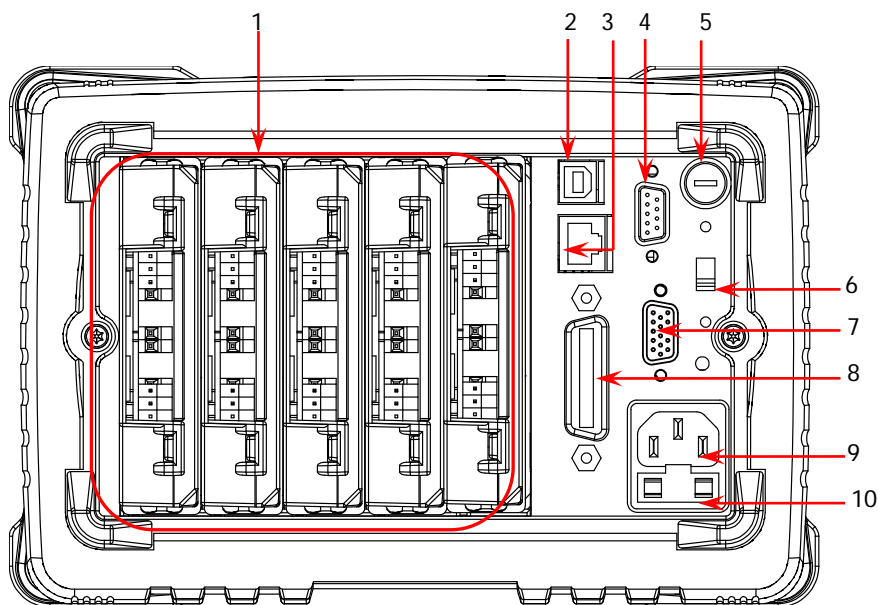

Figure 4 Rear Panel

### 1. Slots

M300 provides 5 slots for 5 modules and only one DMM module is permitted for one mainframe. The 5 slots from left to right in the figure above correspond to the 5 module indicators at the front panel respectively. When a module is inserted in the slot, the corresponding module indicator at the front panel goes on. Figure 4 is the schematic diagram of the rear panel without the modules inserted. For information of each module, refer to “**Plug-in Module Overview**”.



### CAUTION

Only one DMM module is permitted for one mainframe.

### 2. USB Device

Via this interface, M300 can communicate with the PC as a slave device and you can control it remotely via the PC.

### 3. LAN

M300 conforms to the LXI Core Device 2011 instrument standard. The instrument can be connected to the network via this interface and you can control the instrument remotely via a PC in the same network.

### 4. Analog Bus Interface (Female)

M300 provides two internal 2-wire analog buses for signal routing as well as an

external interface (namely Analog Bus Interface). The analog bus interface is a 9-pin female interface.

**5. DMM Module Power Fuse**

The AC power supply from the power socket is divided into two paths with one for the DMM module and the other for other circuits except the DMM module. M300 is equipped with the DMM module power fuse (its specification is AC 250V T250 mA). To replace the fuse, refer to the method below.

- 1) Turn off the instrument and remove the power cord.
- 2) Press down the fuse cover using a straight screw driver and rotate clockwise.
- 3) Disassemble the fuse cap and fuse.
- 4) Replace a specified fuse and install the fuse cap.



**CAUTION**

Please use the specified fuse to avoid electric shock and fire.

**6. Voltage Selector**

M300 supports two kinds of AC voltages (115 V and 230 V). Please select the proper voltage scale according to the AC power used.

**7. RS-232/Alarms/Ext Trig Mix Interface (Male)**

This interface is 25-pin male interface. You can convert this interface into two 9-pin interfaces using the Mix Interface Convert Cable (accessory); wherein, one is a 9-pin male interface used as a standard RS232 interface and the other is a 9-pin female interface used for alarm output, external trigger signal input, etc.

- RS232: via this interface, M300 can communicate with the PC and you can control the instrument remotely via the PC.

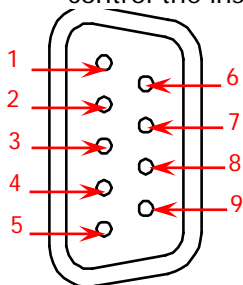

RS232 Interface

Pin	Name	Definition
1	--	--
2	RXD	Received Data
3	TXD	Transmitted Data
4	DTR	Data Terminal Ready
5	SGND	Signal Ground
6	DSR	Data Set Ready
7	RTS	Request To Send
8	CTS	Clear To Send
9	--	--

- Alarms/Ext Trig: as shown in the figure below, pin 1 to pin 4 is used to output TTL pulse when an alarm is generated in the corresponding alarm channel. Pin 6 is used to receive external trigger signal. When an external digital multimeter is connected for measurement, pin 5 and pin 6 are used together to control the measurement.

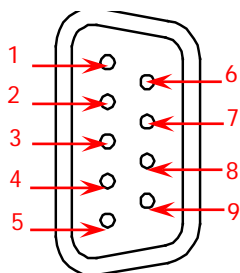

Alarms/Ext Trig Interface

Pin	Definition
1	Alarm 1 Output
2	Alarm 2 Output
3	Alarm 3 Output
4	Alarm 4 Output
5	Channel Closed Output
6	Ext Trig Input/Channel Advance Input
7	GND
8	Not Used
9	Not Used

**Note:** the Pin 5 outputs a TTL negative pulse with about  $7\mu\text{s}$  pulse width each time the measurement is completed. The output rate is dependent upon the actual measurement rate and 1000 times per second at most.

In external trigger mode, when the Pin 6 accepts external trigger signal (which pulse width is equal to or greater than  $2\mu\text{s}$ ) with specified edge (press **Config**, select "External" trigger mode and select "Rising" or "Falling" in **Edge** item), the instrument triggers. If the external trigger signal is continuous pulse, please make sure the pulse period is larger than  $100\mu\text{s}$ .

## 8. GPIB

M300 conforms to the IEEE-488.2 standard. Via this interface, M300 can communicate with the PC and you can control the instrument remotely via the PC.

## 9. Power Socket

M300 can accept two kinds of AC power supplies. Use the power cord provided in the accessories to connect the AC power supply to the instrument via this socket.



### CAUTION

Before connecting the AC power supply, select the correct voltage scale using the **voltage selector**.

## 10. Power Fuse

The specification of the fuse of M300 is AC 250V T3.15 A. If a new fuse is required, please refer to the following steps.

- 1) Turn off the instrument and remove the power cord.
- 2) Insert the small straight screw driver into the slot at the power socket and prize out the fuse seat.
- 3) Replace a specified fuse.
- 4) Insert the fuse seat into the slot.



### CAUTION

Please use the specified power fuse and make sure that the fuse seat is not short-circuited to avoid electric shock and fire.

## Power On and Inspection

### 1. Connect the power

- 1) Adjust the power voltage selector at the rear panel according to the power supply voltage. M300 supports two types of AC power: if your supply voltage is in the range of  $115*(1-10\%)$  V and  $115*(1+10\%)$  V, please select 115 and if it is in the range of  $230*(1-10\%)$  V and  $230*(1+10\%)$  V, please select 230.
- 2) Connect the instrument to AC power using the power cord provided in the accessories.

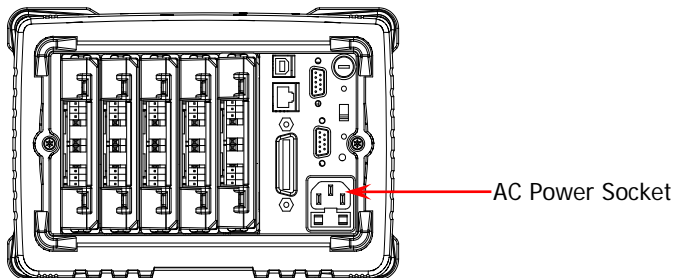

### 2. Start the instrument

Press the power key at the front panel and the instrument starts.

After the instrument starts, it checks the modules. This process would take several to dozens of seconds according to the number of modules inserted. During this process, user operation is forbidden.

### 3. Check the instrument following the steps below if the instrument does not start normally





- Check whether the power is correctly connected.
- Check whether the power key at the front panel is really on.
- Check whether the power fuse is burned out. If the fuse needs to be changed, use the specified fuse.
- Check whether the correct power voltage is selected. Please select the proper power voltage according to the power supply voltage.
- Restart the instrument after finishing the above inspections. If it still does not work correctly, please contact **RIGOL**.

## User Interface



Figure 5 User Interface

### 1. Status Bar

- Help      Displayed when the built-in help is enabled.
- Error     Displayed when an error occurs.
-       Displayed when the keyboard is locked.
-       Displayed when an alarm is generated.
-       Displayed when the system sound is disabled.
-       Displayed when the instrument is connected to network correctly.
-       Displayed when a USB storage device is detected.
- Local     Displayed when the instrument is in local mode.
- Rmt       Displayed when the instrument is in remote mode.

### 2. Content Area

Display the measurement configuration guide, measurement parameters settings, etc. For more detailed information, please refer to the User's Guide.

### 3. Menu Bar

Display the menus of the current function corresponding to the menu softkeys below respectively. Pressing the softkey can activate the corresponding menu.

## Plug-in Module Overview

M300 provides 11 kinds of modules including the DMM module, 20-channel multiplexer, 32-channel multiplexer, 64-channel multiplexer, multi-function module, etc. This section introduces the functions and characteristics of each module.

### Outside View drawing of the module

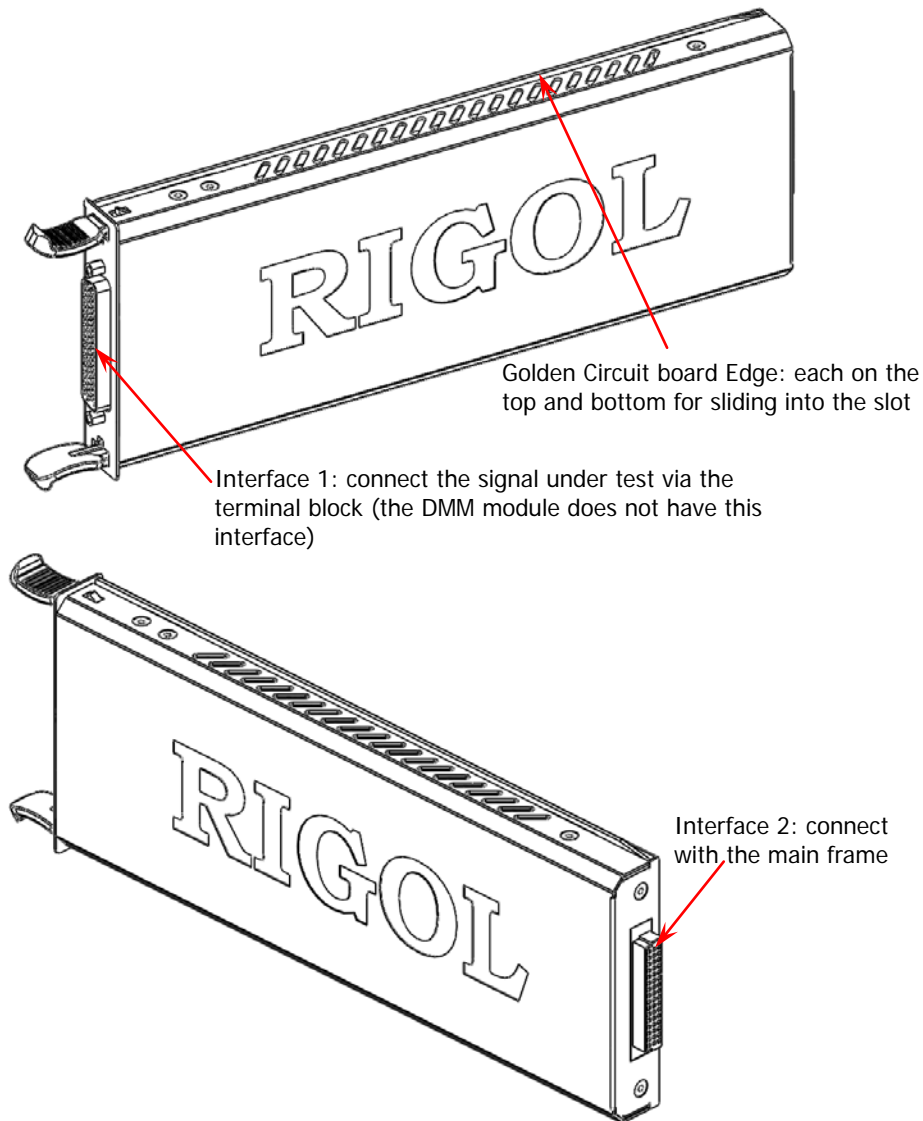

Figure 6 Outside View Drawing of the Module

## Insert the Module into the Mainframe

Please turn the mainframe off firstly and insert the modules following the instructions below.

As shown in Figure 6, there is a golden circuit board edge both on the top and bottom of the module. Aim the two edges with the sliding chutes (as pointed out by the arrows in the figure below) in the main frame slot and push the module in until you hear a sound. At this point, interface 2 is connected to the main frame.

**Note:** please refer to “**Measurement Connections**” to connect the external terminal block and the signals to be measured and then insert it into the mainframe.

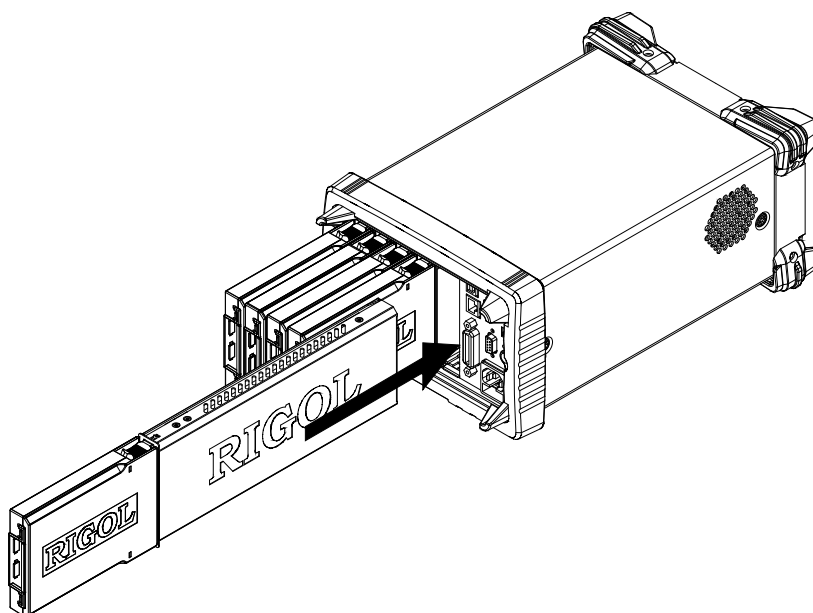

Figure 7 Insert the Module into the Mainframe

**Note:**

All the modules of M300 do not support hot-plugging. Please turn the mainframe off before inserting the modules into the mainframe.

## Module Overview

### 1. MC3065 (DMM Module):

The DMM module is used to measure the signals under test and has 6½ digits reading resolution. The measurement functions include DCV, ACV, 2-wire resistance, 4-wire resistance, frequency, period, temperature and any sensor.

**Note:** After connecting the DMM module, make sure that the signal under test connected to the analog bus is no greater than 300 Vdc or 300 Vrms.

### 2. MC3120 (20-Channel Multiplexer):

All 20 channels switch both HI and LO inputs, thus providing fully isolated inputs to the DMM module. MC3120 is divided into two banks (called A and B) of 10 two-wire channels each. When making 4-wire resistance measurement, the instrument automatically pairs channels of A bank and B bank. All channels are break-before-make. You can close multiple channels on this module only if you have not configured any channel to be part of the scan list. This module can be connected with MC3065 (DMM Module, if MC3065 is currently inserted). For the specifications of this module, please refer to the User's Guide or Data Sheet of this product.

### 3. MC3132 (32-Channel Multiplexer):

All 32 channels switch both HI and LO inputs, thus providing fully isolated inputs to the DMM module. MC3132 is divided into two banks (called A and B) of 16 two-wire channels each. When making 4-wire resistance measurement, the instrument automatically pairs channels of A bank and B bank. All channels are break-before-make. You can close multiple channels on this module only if you have not configured any channel to be part of the scan list. This module can be connected with MC3065 (DMM Module, if MC3065 is currently inserted). For the specifications of this module, please refer to the User's Guide or Data Sheet of this product.

### 4. MC3164 (64-Channel Single-Ended Multiplexer):

All 64 channels can switch HI input only. MC3164 is divided into two banks (A and B) of 32 single-ended channels each. All channels are break-before-make. In any case, you cannot close multiple channels on this module. This module can be connected with MC3065 (DMM Module, if MC3065 is currently inserted) but cannot be used for 4-wire resistance measurement. For the specifications of this module, please refer to the User's Guide or Data Sheet of this product.

### 5. MC3232 (32-Channel Reed Multiplexer):

MC3232 is applicable to high-speed scan and high-throughput auto test applications. All 32 channels can switch both HI and LO inputs, thus providing fully isolated inputs to the DMM module. MC3232 is divided into two banks (A and B) of 16 two-wire channels. When making 4-wire resistance measurement,



the instrument automatically pairs channels of A bank and B bank. All channels are break-before-make. You can close multiple channels on this module only if you have not configured any channel to be part of the scan list. This module can be connected with MC3065 (DMM Module, if MC3065 is currently inserted). For the specifications of this module, please refer to the User's Guide or Data Sheet of this product.

**6. MC3264 (64-Channel Single-Ended Reed Multiplexer):**

MC3264 is applicable to high-speed scan and high-throughput auto test applications. All 64 channels can switch HI input only. MC3264 is divided into two banks (A and B) of 32 single-ended channels each. All channels are break-before-make. In any case, you cannot close multiple channels on this module. This module can be connected with MC3065 (DMM Module, if MC3065 is currently inserted) but cannot be used for 4-wire resistance measurement. For the specifications of this module, please refer to the User's Guide or Data Sheet of this product.

**7. MC3324 (24-Channel Multiplexer):**

MC3324 is a mixed multiplexer with 20 voltage channels and 4 current channels. All 20 voltage channels switch both HI and LO inputs, thus providing fully isolated inputs to the DMM module, and is divided into two banks (called A and B) of 10 two-wire channels each. When making 4-wire resistance measurement, the instrument automatically pairs channels of A bank and B bank. All channels are break-before-make. You can close multiple channels on this module only if you have not configured any channel to be part of the scan list. 4 current channels are used in combination with the DMM module to measure DC current or AC current. All channels are break-before-make. In any case, you cannot close multiple channels on this module. This module can be connected with MC3065 (DMM Module, if MC3065 is currently inserted). For the specifications of this module, please refer to the User's Guide or Data Sheet of this product.

**8. MC3416 (16-Channel Actuator):**

MC3416 can connect signal to the device under test or enable external device. Any of the 16 channels can switch to Normally-Open (NO) and Normally-Closed (NC) states. For the specifications of this module, please refer to the User's Guide or Data Sheet of this product.

**9. MC3534 (Multifunction Module):**

It provides 3 kinds of functions with 4 channels for each function. This module can be used to check status or control external device (such as the solenoid, power relay and microwave switch). You can also read digital inputs and the totalizer count during a scan.

- Four 8-bit digital input/output (DIO) ports
- 4 totalizer (TOT) input terminals (the first two channels are 10 MHz TOT and the other two channels are 100 kHz TOT) with 1 Vpp sensitivity

- 4 analog output terminals,  $\pm 12$  V calibrated voltage

For the specifications of this module, please refer to the User's Guide or Data Sheet of this product.

**10. MC3648 (4×8 Matrix Switch):**

MC3648 is used to connect multiple devices to multiple points on the device under test. You can connect the rows and columns of multiple matrix switches to form relatively larger matrix (such as 8×8 and 4×16, the number of crosspoints cannot exceed 160).

32 two-wire cross points which can connect any combination of inputs and outputs at the same time. For the specifications of this module, please refer to the User's Guide or Data Sheet of this product.

**11. MC3724 (Dual 4-Channel RF Multiplexers):**

MC3724 consists of two independent 4-to-1 multiplexers and can switch high frequency signal or pulse signal. For the specifications of this module, please refer to the User's Guide or Data Sheet of this product.

## To Use the Built-in Help System

The built-in help system of M300 provides the help information about any front panel key and menu. To acquire the help information of any front panel key or menu, press **Help** (the backlight goes on and "Help" is displayed in the status bar in the user interface) and then press the desired key. The built-in help interface is as shown in the figure below. Press **OK** to exit.

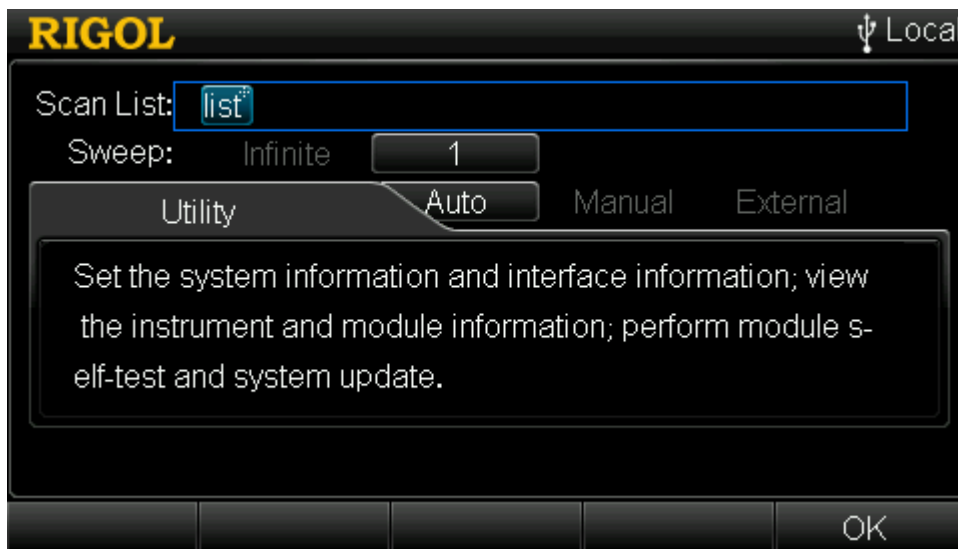
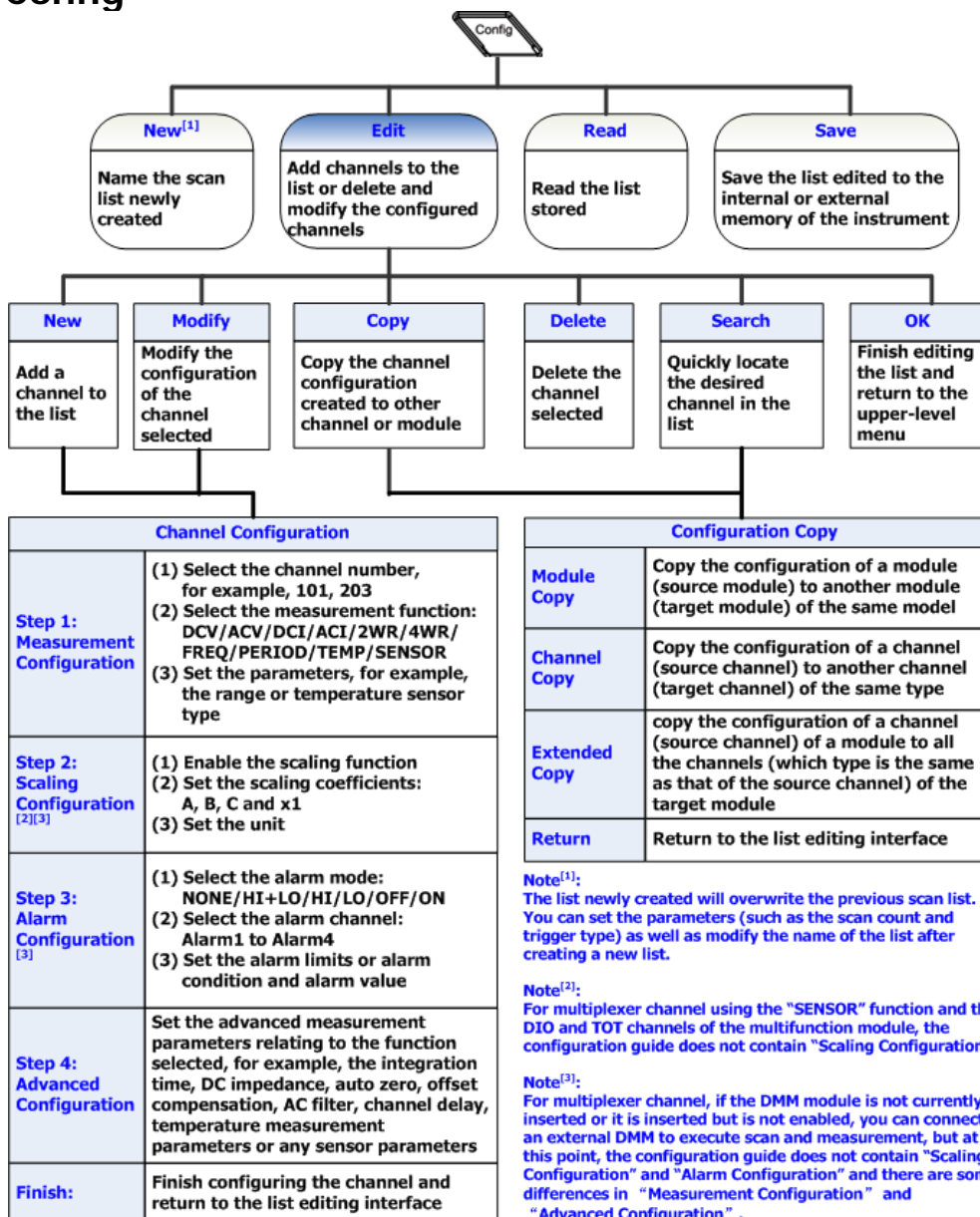

Figure 8 Built-in Help System

## Menu Quick Navigation

This section provides the structures of the main menus for M300 to guide users to quickly get familiar with the operations. For more detailed information, please refer to the User's Guide.

### Config



# Monitor

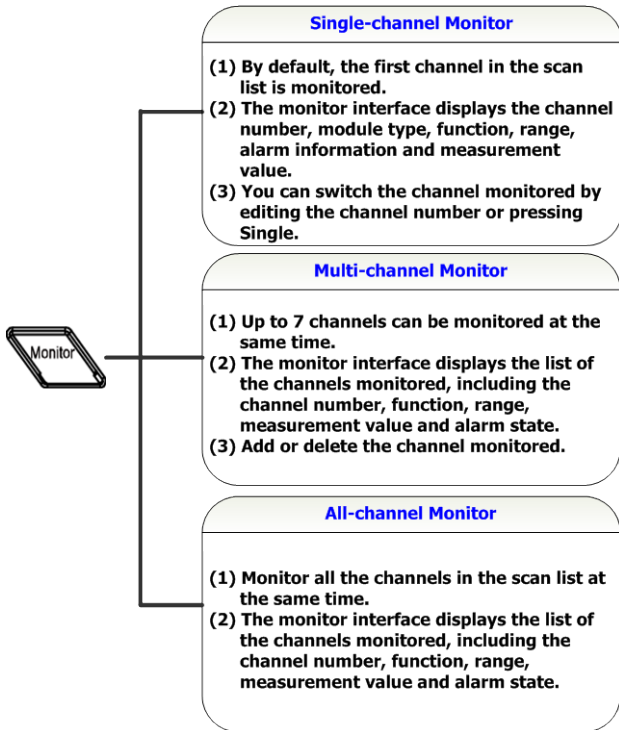

# View Switch Key

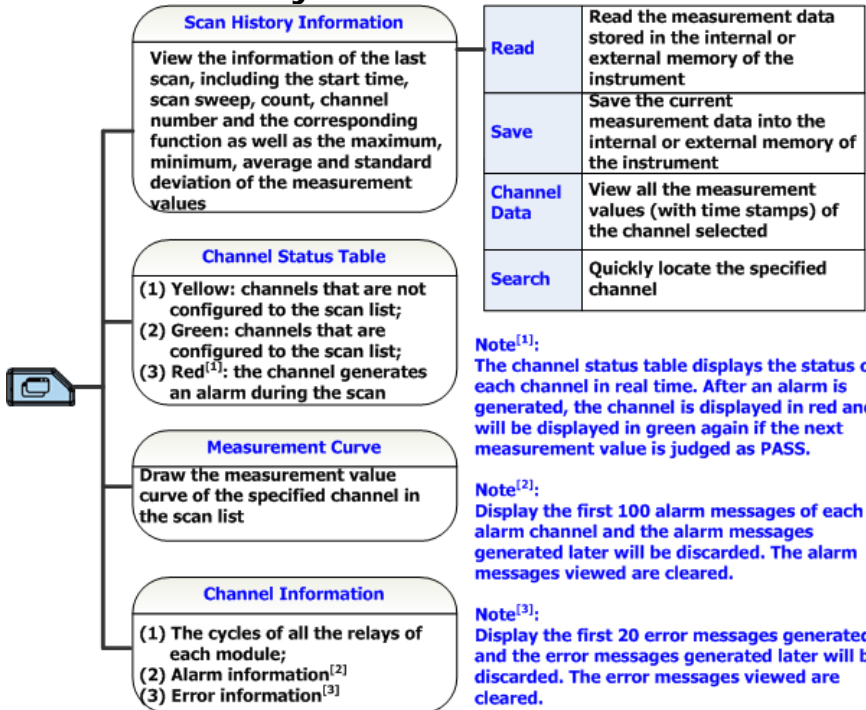

## Control

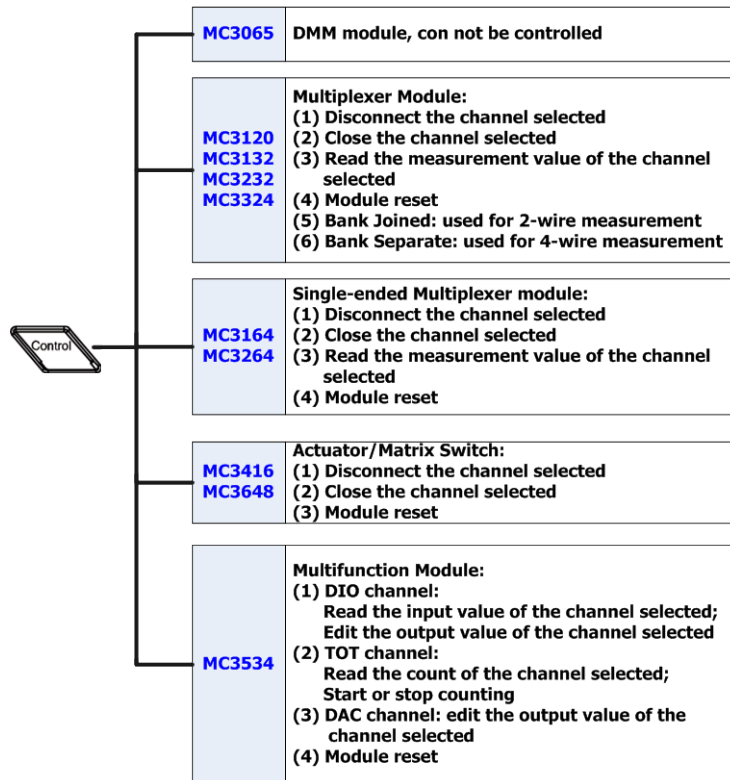

## Alarm Channel Setting Keys

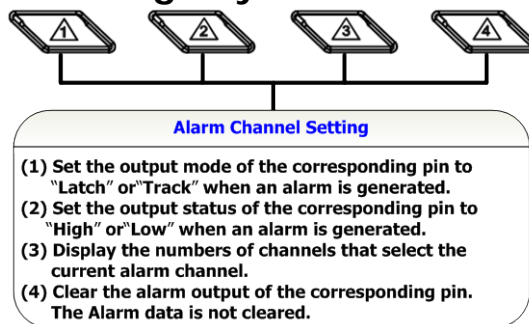

## Basic Operations

This section introduces the basic operations of M300, including how to connect the signals to be measured, how to configure the scan list as well as the remote control method.

## Measurement Connections

Multiple signals to be measured are connected to the plug-in modules through the external terminal blocks and then switched to the DMM module or external DMM. M300 provides 7 kinds of terminal blocks. The models of the terminal blocks and corresponding modules are listed in the table below. This section introduces how to connect the signals to be measured through the external block.

Table 1 External Terminal Blocks

	Terminal Block	Module
1.	M3TB20	MC3120
2.	M3TB32	MC3132, MC3232
3.	M3TB64	MC3164, MC3264
4.	M3TB24	MC3324
5.	M3TB48	MC3648
6.	M3TB16	MC3416
7.	M3TB34	MC3534

**Note:** for the MC3724, the signal can be connected to the SMB connectors on the module directly. No terminal block is needed.



### WARNING

Cut off all the power supplies before opening the terminal block or removing the terminal block from the module.

- Place the terminal block with the front (with the **RIGOL** caption) facing downward and pull the two latches in the arrow direction in the figure below and press them down. Place the terminal block with the front facing upward and pull the upper cover of the terminal block upward and remove it.

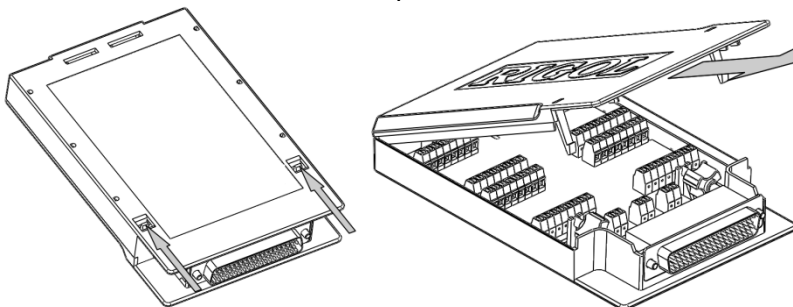

- Connect the cables for connecting the signal under test according to the labels on the circuit board of the terminal block (for the connecting method, refer to Table 2). Pass the binding wires through the two groups of holes as pointed out by the arrows in the figure below to fix the cable connected. Pay attention to the channel or terminal connected to the cable to ensure that the signal connected is correct.

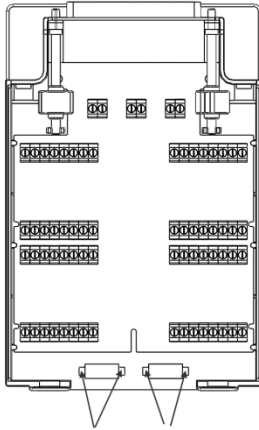

Taking M3TB32 as an example, the detailed layout is as shown in the figure below. From the left bottom corner to the right top corner, 32 pairs of terminals are located. They are corresponded to the 32 channels of MC3132 or MC3232 and can be identified via the labels (CH01-CH32) upper or below the terminals. The figure below shows the connection methods of 2-wire and 4-wire.

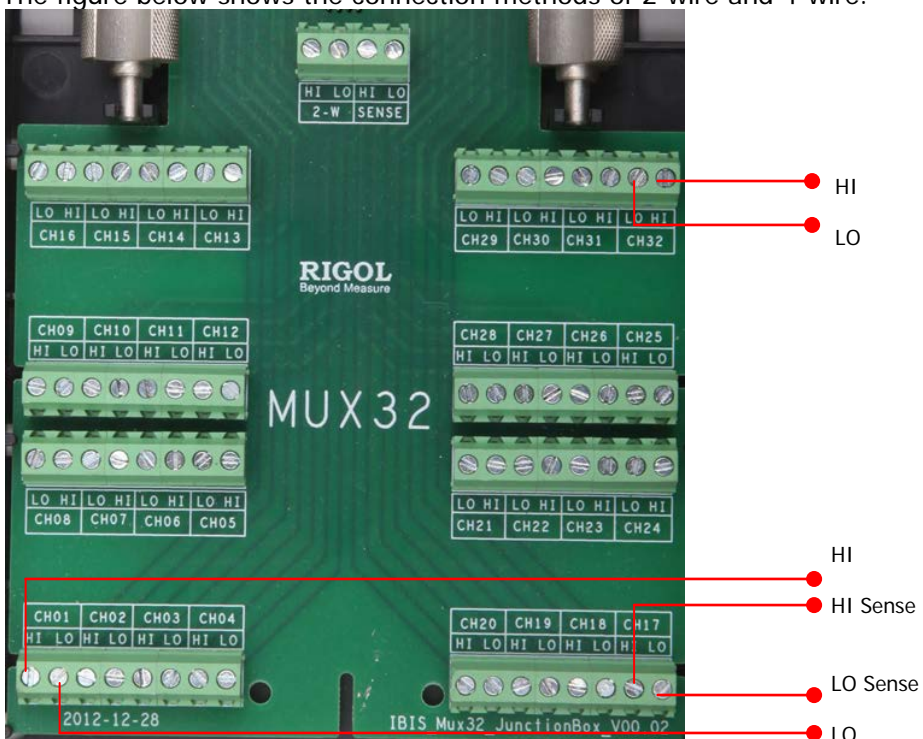
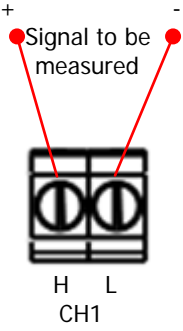
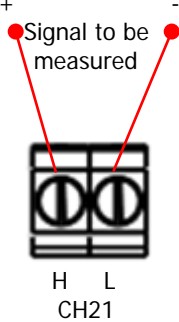
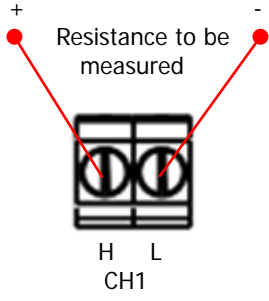
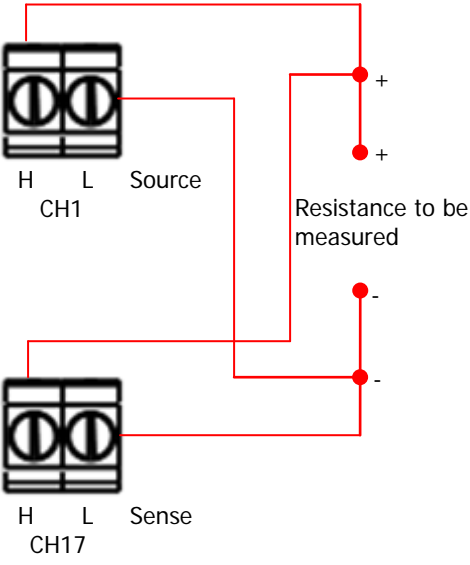
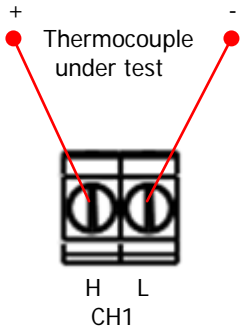

Table 2 Measurement Connections

<p><b>DCV/ACV/FREQ/PERIOD/Sensor (DCV, FREQ)</b></p>  <p>Signal to be measured</p> <p>H L CH1</p>	<p><b>DCI/ACI/ Sensor (DCI)</b></p>  <p>Signal to be measured</p> <p>H L CH21</p> <p>Note: Only available for the channel 21 to channel 24 of MC3324.</p>
<p><b>2WR/RTD/Thermistor/ Sensor (2WR)</b></p>  <p>Resistance to be measured</p> <p>H L CH1</p>	<p><b>4WR/RTD 4W/ Sensor (4WR)</b></p>  <p>H L Source CH1</p> <p>H L Sense CH17</p> <p>Resistance to be measured</p>
<p><b>Thermocouple</b></p>  <p>Thermocouple under test</p> <p>H L CH1</p>	<p>Note: Only available for all the channels of MC3120, MC3132 and MC3232 as well as the channel 1 to channel 20 of MC3324.</p>



**WARNING**

To avoid electric shock, the connecting wire should meet the maximum current requirement. To avoid damaging the module, make sure that all the input signals are within the rated input range.



3. Connect the terminal block to the module via interface 1 (the interface definition is in Figure 6) on the module and screw down the two screw rods onto the nuts on the module.

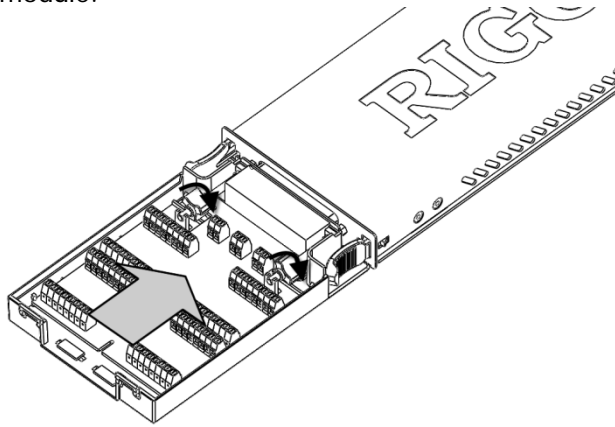

4. Close the upper cover of the terminal block.

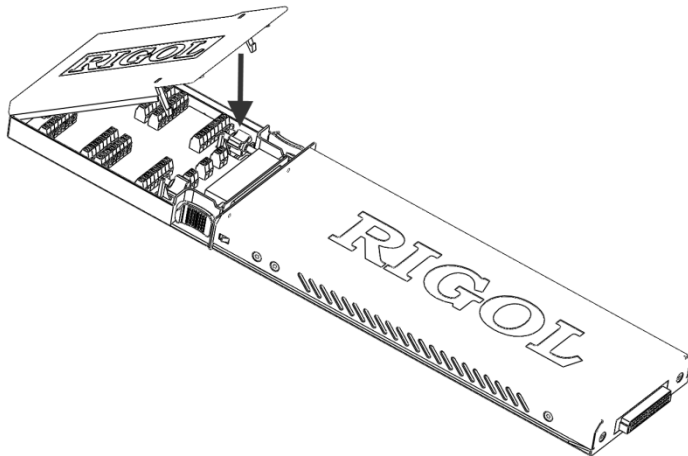

5. Insert the module with the terminal block into the slot of the mainframe.

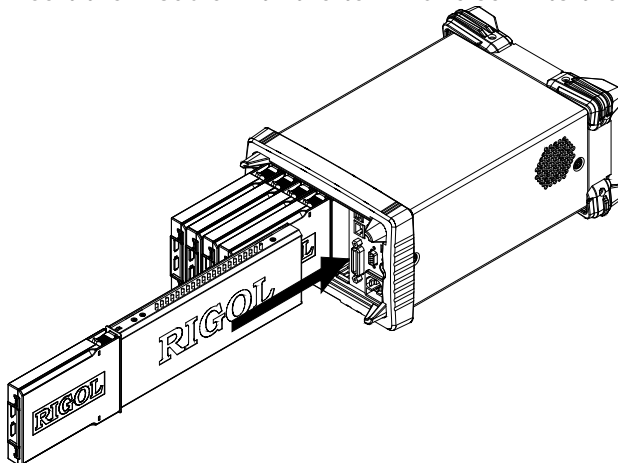

## To Configure Scan List

Create a scan list, add any channels of the multiplexer or the DIO or TOT channels of the multifunction module to the scan list and configure the basic measurement, scaling, alarm and advanced measurement parameters for each channel. The edited scan list can be stored in internal or external memory and be recalled when required.

### 1. To Create a new list

Press **Config** → **New**, input the desired list name and press **OK**.

**Note:** the existed scan list will be overwritten by the scan list created currently.

### 2. To set the scan parameters

- (1) Select **Sweep** and use the left/right direction keys to select "Infinite" or "1" (you need to set a value and the range is from 1 to 50000).
- (2) Select **Trigger Mode** and use the left/right direction keys to select "Auto", "Manual", "External", "AbsTime" or "Alarm".
- (3) If "Auto" is selected, please select **Interval** and use the numeric keyboard to set a desired interval. The range is from 00:00:00.000 to 99:59:59.999 (the time format is Hour:Minute:Second.Millisecond) and the default is 0.  
If "External" is selected, please select **Edge** and use the left/right direction keys to select "Rising" or "Falling".  
If "AbsTime" is selected, please select **AbsTime** and use the numeric keyboard to set a desired time. The time format is "Month-Date Hour:Minute:Second".  
If "Alarm" is selected, please select **Channel** and use the left/right direction keys to select "Alarm1", "Alarm2", "Alarm3" or "Alarm4".

### 3. Configure a channel to the scan list (taking the DCV measurement function as an example)

Press **Config** → **Edit** → **New** to enter the channel configuration guide.

- (1) Step 1: Measurement Configuration  
Select **Chan No.** and use the left/right direction keys to select the desired channel number (for example, 101);  
Select **Function** and use the left/right direction keys to select the desired function (for example, DCV);  
Select **Range** and use the left/right direction keys to select the desired range (for example, 2V).

**Note:** The parameters needed to be set in this step depend on the selected function.

- (2) Step 2: Scaling Configuration  
Select **Scaling** and use the left/right direction keys to enable the scaling configuration;

Select **A**, **B** and **C** and use the numeric keyboard to input the desired scaling coefficients;

Select **x1** and press **Curr Value** to acquire x1.

Select **Unit** and input the desired unit.

**Note:** for multiplexer channel using the "SENSOR" function and the DIO and TOT channels of the multifunction module, the configuration guide does not contain scaling configuration. Besides, for multiplexer channel, if the DMM module is not currently inserted or it is inserted but is not enabled, the configuration guide also does not contain "Scaling Configuration" when you connect an external DMM to execute scan and measurement.

(3) Step 3: Alarm Configuration

Select **Mode** and use the left/right direction keys to select the desired alarm mode (for example, HI);

Select **Channel** and use the left/right direction keys to select the desired alarm channel (for example, Alarm1);

Select **HI** or **LO** and use the numeric keyboard to input the desired alarm limit (for example, 12).

**Note:** for multiplexer channel, if the DMM module is not currently inserted or it is inserted but is not enabled, the configuration guide does not contain "Alarm Configuration" when you connect an external DMM to execute scan and measurement.

(4) Step 4: Advanced Configuration

Select **Integ** and use the left/right direction keys to select the desired integration time (for example 1PLC);

Select **IMP** and use the left/right direction keys to select 10MΩ or >10GΩ;

Select **AZ** and use the left/right direction keys to select "ON" or "OFF";

Select **Delay** and use the left/right direction keys to "Auto" or set the delay time manually.

**Note:** the parameters needed to be set in this step depend on the selected function.

Press **Done** to finish the channel configuration guide and return to the scan list edit interface.

#### 4. Configure other channels to the scan list

Press **New** and configure other channels to the scan list according to the step 3.

#### 5. Save the scan list

After the scan list configuration is completed, press **Save** to save the configured scan list in internal or external memory.

## Configuration Copy

M300 provides configuration copy function (including module copy, channel copy and extended copy) which can configure multi channels with same configuration to the scan list easily and quickly. Press **Config** → **Edit** → **Copy** to enter the copying interface.

### 1. Module Copy:

Copy the configuration of a module (source module) to another module (target module) of the same model. After that, the configuration of each channel of the source module is copied to the target module automatically.

Press **Module** in the copying interface to enter the module copy interface.

- (1) The "Source Module" area is selected by default. Use the up/down direction keys to select the desired source module.
- (2) Press **Switch** to move the cursor to the "Target Module" area and use the up/down direction keys to select the desired target module.
- (3) Press **OK** to execute module copy.

**Note:** the source module and target module selected must be of the same model and it is forbidden to copy the configuration of a module to itself.

### 2. Channel Copy:

Copy the configuration of a channel (source channel) to other one channel or multiple channels (target channel) of the same type.

Press **Channel** in the copying interface to enter the channel copy interface. The channel selected is fixed as the source channel and the upper area is selected by default. At this point, use the left/right direction keys to select the desired target channel, press **OK** to confirm it (press **OK** again to cancel it) and press **Done** to execute channel copy.

You also can press **Switch** to fix the channel selected as the target channel after entering the channel copy interface. At this point, the lower area is selected. Use the left/right direction keys to select the desired source channel and press **Done** to execute channel copy.

Tips:

- (1) When the channel selected is fixed as the source channel, multiple target channels can be selected and are displayed in the lower area.
- (2) When the channel selected is fixed as the target channel, only one source channel can be selected.
- (3) The **Switch** menu is gray and disabled if the scan list only has one channel.

**Note:** for channel copy, only copies between channels with the same type

(namely, channels of the same type of modules) are allowed.

### 3. Extended Copy:

Copy the configuration of a channel (source channel) of a module to all the channels (which type is the same to that of the source channel) of the target module.

Press **Extended** in the copying interface to enter the extended copy interface.

- (1) The "Source Channel" area is selected by default. Use the direction keys to select the desired source channel.
- (2) Press **Switch** to move the cursor to the "Target Module" area and use the up/down direction keys to select the desired target module.
- (3) Press **OK** to execute extended copy.

**Note:** for extended copy, only copies among the same type of modules are allowed. This function makes it easy to configure several channels for the same measurement.

## Channel Monitor

The channel monitor function of M300 allows users to monitor a single channel, multiple channels or all of the channels in the scan list. The instrument monitors the channel and takes readings from the channel monitored continuously even during a scan. This function is helpful for troubleshooting your system before a test or for watching an important signal.

The channel monitor function can monitor the following channels: multiplexer channels (configured to the scan list and the DMM module is enabled), DIO and TOT channels of the multifunction module (no matter whether they are configured to the scan list and the DMM module is not required). Press **Monitor** at the front panel to configure the channel monitor function.

### 1. Single-channel Monitor

Press **Monitor** → **Single** to enter the single-channel monitor interface. By default, the first channel in the scan list is monitored. If no scan list is currently configured, the first channel of the multifunction module (DIO channel) is monitored. Only one channel can be monitored at a time, but you can change the channel being monitored at any time. Readings acquired during a monitor are not stored in memory but they are displayed on the screen. When the alarm function are applied to the selected channel during monitor, all the alarm data is stored in the alarm queue (which will be cleared at power-off). You can monitor a multiplexer channel only if the DMM module is installed and enabled (**Utility** → **DMM** → "ON"). The channel must also be configured to be part of the scan list. You can monitor a DIO or TOT channel even if the channel is not part of the

scan list.

## 2. Multi-channel Monitor

Press **Monitor** → **Multiple** to enter the multi-channel monitor interface. At most 7 channels can be monitored. You can add or delete the channels being monitored.

## 3. All Channel Monitor

Press **Monitor** → **All Moni** to enter the all channel monitor interface. All channels in the scan list can be monitored.

# Remote Control

M300 can communicate with PC through USB, LAN, GPIB and RS232 (converted from the **[RS-232/Alarms/Ext Trig]** interface at the rear panel of M300) to realize remote control based on the SCPI (Standard Commands for Programmable Instruments) commands. This section introduces how to use **Ultra Sigma** to control the instrument remotely through USB interface. For the detailed information about the SCPI commands, please refer to the Programming Guide.

## 1. To install Ultra Sigma

Download the Ultra Sigma common PC software from [www.rigol.com](http://www.rigol.com) and install it according to the instructions.

## 2. To control the instrument via USB

### (1) Connect the devices

Connect the USB Device interface of M300 to the USB Host interface of your computer using the USB cable.

### (2) Install the USB driver

This instrument is a USB-TMC device. After you connect it to the PC and turn both on for the first time, the New Hardware Wizard is displayed on the PC. Please install the "USB Test and Measurement Device" driver following the directions in the wizard.

### (3) Search device resource

Start up the **Ultra Sigma** and the software will automatically search for the power supply resources currently connected to the PC. You can also click **USB-TMC** to search the resources.

### (4) View the device resource

The resources found will appear under the "RIGOL Online Resource" directory and the model number and USB interface information of the instrument will also be displayed as shown in the figure below.

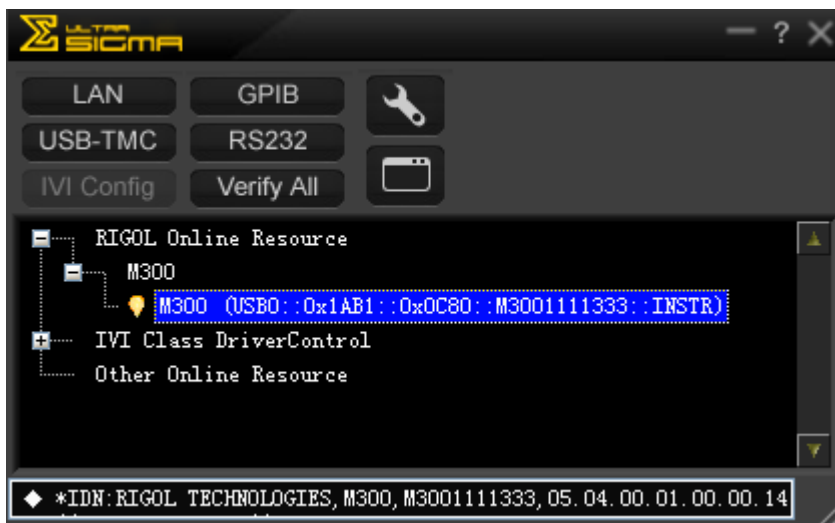

Figure 9 View USB Instrument Resource

### (5) Communication test

Right click the resource name "M300 (USB0::0x1AB1::0x0C80::M3001111333::INSTR)" to select "SCPI Panel Control" to turn on the remote command control panel (as shown in the figure below) through which you can send commands and read data.

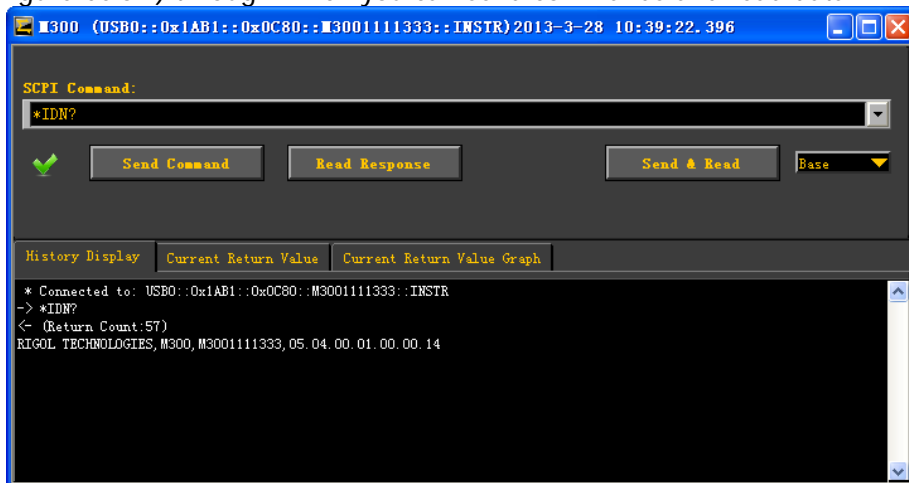



Figure 10 Read and Write Commands through USB

**Note:** when the instrument is in remote mode, **Rmt** is displayed in the status bar in the user interface and all the keys except  are locked. At this point, press  to exit the remote mode.

# Troubleshooting

When the questions and failures listed occur, please solve them according to the following method. If the problem remains, please contact **RIGOL** and provide the device information of your instrument (**Utility** → **Info**).

## 1. The instrument does not start.

- 1) Check the power cable connection.
- 2) Check whether the power switch at the front panel is turned on.
- 3) Remove the power cord and check whether the voltage selector is at the proper scale and whether the fuse specification is correct and the fuse is in good condition. To replace the fuse refer to the instructions.
- 4) Restart the instrument after executing the above steps.
- 5) If the problem remains, please contact **RIGOL**.

## 2. The USB storage device cannot be recognized.

- (1) Check whether the USB storage device can work normally.
- (2) Make sure the USB storage device used is Flash storage type, as this instrument does not support hardware storage type USB storage device.
- (3) Restart the instrument and insert the USB storage device to check it.
- (4) If the USB storage device still cannot work normally, please contact **RIGOL**.



## 3. How to recover the configurations from the last power failure or unexpected shutdown and continue the work before the shutdown automatically?

Restart the instrument. Press **Utility** → **System**, select **Power-off** using the up/down direction keys and select "ON" using the left/right direction keys.

## 4. The screen is too dark?

Press **Utility** → **System**, select **Brightness** using the up/down direction keys and set the proper brightness using the left/right direction keys.

## 5. The instrument is locked?

- 1) Check whether the instrument is in remote mode (namely check whether "Rmt" is displayed in the status bar of the interface). If yes, press the  key to exit the remote mode and unlock the instrument.
- 2) Check whether the front panel of the instrument is locked (namely check whether  is displayed in the status bar of the interface). If yes, press and hold the  key to unlock the front panel.
- 3) Check whether a progress bar is displayed in the interface. If yes, please wait for a moment and operate the instrument when the progress bar disappears.
- 4) If the problem remains, please restart the instrument.



## 6. How to change the system language?

Press **Utility** → **System**, select **Language** using the up/down direction keys and select your desired language using the left/right direction keys.

## 7. How to view the information and model number of the plug-in modules?

Press **Utility** → **Test**, select the desired module using the left/right direction keys and press **View** to view the information of the module currently selected, including the function, model, serial number and version.

## 8. The corresponding indicator at the front panel does not go on when the module has been inserted?

- 1) Press **Utility** → **Test**, select the desired module using the left/right direction keys and press **Re-test**.
- 2) If the problem remains, press **View** to view the information of the module. If the information of the module does not been displayed correctly, please refer to the problem 9.
- 3) If the information of the module is displayed correctly, the module indicator is possibly damaged, please contact **RIGOL** to consult maintenance information.

## 9. Unable to view the information of the module or unable to use the module when the module has been inserted?

- 1) Turn the mainframe off, pluck the module from the mainframe and insert the module into the mainframe again firmly.
- 2) Restart the mainframe, wait for about 1 minute and view the module information again.
- 3) If the problem remains, please contact **RIGOL**.

## 10. Unable to do the configurations or operations related to the DMM module when it has been inserted?

- 1) Ensure the setting of **Utility** → **System** → **DMM** is "ON".
- 2) Press **Utility** → **Test**, select the DMM module using the left/right direction keys and press **View** to view the information of the DMM module. If the information does not been displayed or displayed correctly, the DMM module is abnormal due to high current or power load failure probably. At this point, please turn the mainframe off and restart it a few minutes later.
- 3) If the problem remains, please contact **RIGOL**.

## 11. The GPIB interface does not work normally?

- 1) Check whether the cable works normally and the connection is correct and reliable.
- 2) Ensure the GPIB addresses of the M300 and those of the computer are identical.
- 3) If the problem remains, please contact **RIGOL**.

**12. The USB Device interface does not work normally?**

- 1) Check whether the cable works normally and the connection is correct and reliable.
- 2) Check whether the “USB Test and Measurement Device” drive program has been installed in your computer.
- 3) If the problem remains, please contact **RIGOL**.

**13. The RS232 interface does not work normally?**

- 1) Ensure the RS232 parameters (baud rate, etc.) of M300 and those of the computer are identical.
- 2) Check whether the RS232 cable is a cross line.
- 3) If the problem remains, please contact **RIGOL**.

**14. The LAN interface does not work normally?**

- 1) Check whether the cable works normally and the connection is correct and reliable.
- 2) Check the IP address configuration mode:
  - If DHCP is enabled, please ensure the network supports DHCP mode and can distribute network parameters (such as the IP address) to the instrument automatically.
  - If DHCP is disabled and Auto IP is enabled, please ensure the IP addresses of M300 and computer is in the same network segment.
  - If Manual IP is enabled, please ensure the IP addresses of M300 and computer is in the same network segment.
- 3) If the problem remains, please contact **RIGOL**.