

**RIGOL**

**User's Guide**

**DG4000 Series Function/Arbitrary  
Waveform Generator**

**May 2012**

**RIGOL Technologies, Inc.**



# Guaranty and Declaration

## Copyright

© 2011 RIGOL Technologies, Inc. All Rights Reserved.

## Trademark Information

**RIGOL** is a registered trademark of **RIGOL** Technologies, Inc.

## Publication Number

UGB04105-1110

## Notices

- **RIGOL** products are protected by patent law in and outside of P.R.C.
- **RIGOL** reserves the right to modify or change parts of or all the specifications and pricing policies at company's sole decision.
- Information in this publication replaces all previously corresponding material.
- **RIGOL** shall not be liable for losses caused by either incidental or consequential in connection with the furnishing, use or performance of this manual as well as any information contained.
- Any part of this document is forbidden to be copied or photocopied or rearranged without prior written approval of **RIGOL**.

## Product Certification

**RIGOL** guarantees this product conforms to the national and industrial standards in China as well as the ISO9001:2008 standard and the ISO14001:2004 standard. Other international standard conformance certification is in progress.

## Contact Us

If you have any problem or requirement when using our products, please contact **RIGOL** or your local distributors, or visit: [www.rigol.com](http://www.rigol.com).

# Safety Requirement

## General Safety Summary

Please review the following safety precautions carefully before putting the instrument into operation so as to avoid any personal injuries or damages to the instrument and any product connected to it. To prevent potential hazards, please use the instrument only specified by this manual.

### **Use Proper Power Cord.**

Only the power cord designed for the instrument and authorized by local country could be used.

### **Ground The Instrument.**

The instrument is grounded through the Protective Earth lead of the power cord. To avoid electric shock, it is essential to connect the earth terminal of power cord to the Protective Earth terminal before any inputs or outputs.

### **Observe All Terminal Ratings.**

To avoid fire or shock hazard, observe all ratings and markers on the instrument and check your manual for more information about ratings before connecting.

### **Use Proper Overvoltage Protection.**

Make sure that no overvoltage (such as that caused by a thunderstorm) can reach the product, or else the operator might expose to danger of electrical shock.

### **Change The Power Fuse.**

If the power fuse needs to be changed, please return the instrument back to our factory and the **RIGOL** authorized operator will change it for you.

### **Do Not Operate Without Covers.**

Do not operate the instrument with covers or panels removed.

### **Avoid Circuit or Wire Exposure.**

Do not touch exposed junctions and components when the unit is powered.

**Do Not Operate With Suspected Failures.**

If you suspect damage occurs to the instrument, have it inspected by qualified service personnel before further operations. Any maintenance, adjustment or replacement especially to circuits or accessories must be performed by **RIGOL** authorized personnel.

**Keep Well Ventilation.**

Inadequate ventilation may cause increasing of temperature or damages to the device. So please keep well ventilated and inspect the intake and fan regularly.

**Do Not Operate In Wet Conditions.**

In order to avoid short circuiting to the interior of the device or electric shock, please do not operate in a humid environment.

**Do Not Operate in an Explosive Atmosphere.**

In order to avoid damages to the device or personal injuries, it is important to operate the device away from an explosive atmosphere.

**Keep Product Surfaces Clean and Dry.**

To avoid the influence of dust and/or moisture in air, please keep the surface of device clean and dry.

**Electrostatic Prevention.**

Operate in an electrostatic discharge protective area environment to avoid damages induced by static discharges. Always ground both the internal and external conductors of the cable to release static before connecting.

**Handling Safety**

Please handle with care during transportation to avoid damages to buttons, knob interfaces and other parts on the panels.

## Safety Terms and Symbols

**Terms in this Manual.** These terms may appear in this manual:



---

### **WARNING**

Warning statements indicate the conditions or practices that could result in injuries or loss of life.

---



---

### **CAUTION**

Caution statements indicate the conditions or practices that could result in damage to this product or other property.

---

**Terms on the Product.** These terms may appear on the product:

**DANGER** indicates an injury or hazard may immediately happen.

**WARNING** indicates an injury or hazard may be accessible potentially.

**CAUTION** indicates a potential damage to the instrument or other property might occur.

**Symbols on the Product.** These symbols may appear on the product:



**Hazardous  
Voltage**



**Please Refer to  
Manuals**



**Protective  
Earth  
Terminal**



**Chassis  
Ground**



**Test  
Ground**

---

## General Care and Cleaning

### General Care:

Do not store or leave the instrument in where the instrument will be exposed to direct sunlight for long periods of time.

### Cleaning:

Clean the instrument regularly according to its operating conditions. To clean the exterior surface, perform the following steps:

1. Disconnect the instrument from all power sources.
2. Clean the loose dust on the outside of the instrument with a lint- free cloth (with a mild detergent or water). When cleaning the LCD, take care to avoid scarifying it.



#### **CAUTION**

To avoid damages to the instrument, do not expose them to liquids which have causticity.

---



#### **WARNING**

To avoid injury resulting from short circuit, make sure the instrument is completely dry before reconnecting to a power source.

---

## Environmental Considerations

The following symbol indicates that this product complies with the applicable European Union requirements according to Directives 2002/96/EC on waste electrical and electronic equipment (WEEE) and batteries.



### **Product End-of-Life Handling**

The equipment may contain substances that could be harmful to the environment or human health. In order to avoid release of such substances into the environment and harm to human health, we encourage you to recycle this product in an appropriate system that will ensure that most of the materials are reused or recycled appropriately. Please contact your local authorities for disposal or recycling information.



---

## DG4000 Series Overview

DG4000 is a dual-channel economical, high-performance and multifunctional generator that combines many functions in one, including Function Generator, Arbitrary Waveform Generator, Pulse Generator, Harmonics Generator, Analog/Digital modulator and Counter. All the models of DG4000 provide two channels with equivalent functions and adjustable phase between the two channels.

### Main Features:

- Adopt the Direct Digital Synthesizer (DDS) technology and provide stable, precise, pure and low distortion signals.
- 7 inches, 16M true color TFT LCD, displaying parameters and graphics of the two channels at the same time.
- 160MHz, 100MHz or 60MHz maximum output frequency (for Sine), 500MSa/s sample rate, 14bits vertical resolution.
- Precisely adjust the phases of the two channels.
- 150 waveforms or functions: Sine, Square, Ramp, Pulse, Noise, Sinc, Exponential Rise, Exponential Fall, ECG, Gauss, Haversine, Lorentz, Dual Tones, Harmonics, Video Signal, Radar Signal, DC etc.
- Enable to edit 16kpts arbitrary waveform and support point by point output of arbitrary waveform.
- Rise Time and Fall Time of the Pulse could be adjusted separately.
- Enable to output harmonic with specified order and amplitude, enable to output up to 16<sup>th</sup> order of harmonic.
- Support to superpose Gauss Noise onto basic waveforms.
- Various modulation types: AM, FM, PM, ASK, FSK, PSK, BPSK, QPSK, 3FSK, 4FSK, OSK and PWM modulations.
- Support frequency sweep and Burst output.
- Dual channels can perform internal/external modulation and internal/external/manual trigger separately or at the same time.
- Dual channels can output sync signal separately or at the same time.
- Support to enable Frequency Coupling, Phase Coupling and Amplitude Coupling separately or at the same time.
- Provide 7digits/s, 200MHz counter; enable to measure various parameters of external signal such as frequency, period, duty cycle, positive pulse width and negative pulse width; provide statistic function of measurement results.
- Support waveform copy and state copy between channels.
- Enable to store and recall 10 arbitrary waveform data files and 10 instrument

state files as well as recall Csv and Txt files stored in USB storage device.

- Plenty of standard interfaces: USB Host, USB Device and LAN
- Abundant I/O: waveform output, sync signal output, modulation input, 10MHz clock input/output, trigger input/output.
- Support USB storage device using FAT file system.
- Support remote control through 10/100M Ethernet web.
- Conform to LXI-C instrument standards (Version 1.2).
- Provide Chinese and English built-in help and input methods.
- Provide powerful waveform editing PC software.
- Provide security lock hole.

---

# Document Overview

## Subjects in this Manual:

### **Chapter 1 Quick Start**

This chapter introduces the front/rear panel, user interface and parameter setting method, as well as announcements during first use of the instrument.

### **Chapter 2 Basic Waveform Output**

This chapter introduces how to output basic waveforms, e.g. Sine and Square.

### **Chapter 3 Arbitrary Waveform Output**

This chapter introduces how to output built-in or user-defined waveforms.

### **Chapter 4 Harmonics Output**

This chapter introduces how to output harmonics with specified order.

### **Chapter 5 Modulated Waveform Output**

This chapter introduces how to output modulated waveforms, e.g. AM, FSK and PWM.

### **Chapter 6 Sweep**

This chapter introduces how to generate a frequency Sweep.

### **Chapter 7 Burst**

This chapter introduces how to generate a Burst waveform.

### **Chapter 8 Counter**

This chapter introduces how to use the counter.

### **Chapter 9 Store and Recall**

This chapter introduces how to store and recall the waveform data or the instrument state settings.

### **Chapter 10 Utility and System Settings**

This chapter introduces some utility functions and setting methods of system parameters.

### **Chapter 11 Remote Control**

This chapter introduces how to control the instrument remotely.

### **Chapter 12 Troubleshooting**

This chapter lists commonly encountered failures that may appear during the use of the generator and their solutions.

**Chapter 13 Specifications**

This chapter lists the performances and general specifications of the instrument.

**Chapter 14 Appendix**

This chapter provides the information about the options and accessories, as well as other points for attention.

**Format Conventions in this Manual:****1. Buttons:**

The function key at the front panel is denoted by the format of "Text Box + Button Name (Bold)" in the manual, for example, **Sine**.

**2. Menu Softkey:**

The menu softkey is denoted by the format of "Character Shading + Menu Word (Bold)" in the manual, for example, **Freq**.

**3. Connector**

The connector at the front or rear panel is denoted by the format of "Brackets+Connector Name (Bold)" in the manual, for example, **[Sync]**.

**4. Operation Steps:**

The next step of the operation is denoted by an arrow "→" in the manual. For example, **Sine** → **Freq** represents pressing the function key **Sine** at the front panel and then pressing the menu softkey **Freq**.

**Content Conventions in this Manual:**

DG4000 series cover the following models. This manual takes DG4162 as an example.

<b>Model</b>	<b>Channels</b>	<b>Max. Frequency</b>	<b>Sample Rate</b>
DG4062	2	60MHz	500MSa/s
DG4102	2	100MHz	500MSa/s
DG4162	2	160MHz	500MSa/s

# Contents

<b>Guaranty and Declaration .....</b>	<b>I</b>
<b>Safety Requirement .....</b>	<b>II</b>
General Safety Summary .....	II
Safety Terms and Symbols .....	IV
General Care and Cleaning .....	V
<b>Environmental Considerations .....</b>	<b>VI</b>
<b>DG4000 Series Overview.....</b>	<b>VII</b>
<b>Document Overview.....</b>	<b>IX</b>
<b>Chapter 1 Quick Start .....</b>	<b>1-1</b>
General Inspection .....	1-2
To Adjust the Supporting Legs .....	1-3
Appearance and Dimensions .....	1-4
Front Panel .....	1-6
Rear Panel .....	1-13
To Connect to Power.....	1-16
User Interface.....	1-17
Parameter Setting Method.....	1-20
Numeric Keyboard.....	1-20
Direction keys and Knob .....	1-21
To Use the Built-In Help .....	1-22
To Use the Security Lock .....	1-23
To Use the Rack Mount Kit .....	1-24
Kit Parts List .....	1-24
Installation Tool .....	1-25
Installation Space .....	1-26
Installation Procedure .....	1-28
<b>Chapter 2 Basic Waveform Output .....</b>	<b>2-1</b>
To Select Output Channel.....	2-2
To Select Basic Waveform.....	2-3
To Set Frequency .....	2-4
To Set Amplitude.....	2-5

To Set DC Offset Voltage.....	2-7
To Set Start Phase.....	2-8
Align Phase .....	2-9
To Set Duty Cycle.....	2-11
To Set Symmetry.....	2-12
To Set Parameters for Pulse .....	2-13
Pulse Width/Duty Cycle .....	2-13
Leading/Trailing Edge Time.....	2-14
Delay .....	2-15
Recover Delay .....	2-15
To Enable Output .....	2-17
Basic Waveform Output Example .....	2-18
<b>Chapter 3 Arbitrary Waveform Output .....</b>	<b>3-1</b>
To Enable Arbitrary Waveform .....	3-2
Point By Point Output Mode .....	3-3
To Select Arbitrary Waveform .....	3-4
Built-In Waveform.....	3-4
Stored Waveform.....	3-9
Volatile Waveform.....	3-9
To Create New Arbitrary Waveform .....	3-10
Example: Edit Points .....	3-13
Example: Edit Block .....	3-15
To Edit Arbitrary Waveform .....	3-17
<b>Chapter 4 Harmonic Output .....</b>	<b>4-1</b>
Overview.....	4-2
To Set Fundamental Waveform Parameters.....	4-2
To Set Harmonic Order .....	4-3
To Select Harmonic Type.....	4-3
To Set Harmonic Amplitude .....	4-4
To Set Harmonic Phase.....	4-5
<b>Chapter 5 Modulated Waveform Output .....</b>	<b>5-1</b>
AM .....	5-2
To Select AM Modulation .....	5-2
To Select Carrier Waveform Shape.....	5-2
To Set Carrier Frequency .....	5-2
To Select Modulating Waveform Source.....	5-3

---

To Set Modulating Waveform Frequency .....	5-4
To Set Modulation Depth .....	5-4
FM .....	5-5
To Select FM Modulation .....	5-5
To Select Carrier Waveform Shape .....	5-5
To Set Carrier Frequency .....	5-5
To Select Modulating Waveform Source .....	5-6
To Set Modulating Waveform Frequency .....	5-7
To Set Frequency Deviation .....	5-7
PM .....	5-8
To Select PM Modulation .....	5-8
To Select Carrier Waveform Shape .....	5-8
To Set Carrier Frequency .....	5-8
To Select Modulating Waveform Source .....	5-9
To Set Modulating Waveform Frequency .....	5-10
To Set Phase Deviation .....	5-10
ASK .....	5-11
To Select ASK Modulation .....	5-11
To Select Carrier Waveform Shape .....	5-11
To Set Carrier Amplitude .....	5-11
To Select Modulating Waveform Source .....	5-12
To Set ASK Rate .....	5-12
To Set Modulating Amplitude .....	5-13
To Set Modulating Polarity .....	5-13
FSK .....	5-14
To Select FSK Modulation .....	5-14
To Select Carrier Waveform Shape .....	5-14
To Set Carrier Frequency .....	5-14
To Select Modulating Waveform Source .....	5-15
To Set FSK Rate .....	5-16
To Set Hop Frequency .....	5-16
To Set Modulating Polarity .....	5-16
PSK .....	5-17
To Select PSK Modulation .....	5-17
To Select Carrier Waveform Shape .....	5-17
To Set Carrier Phase .....	5-17
To Select Modulating Waveform Source .....	5-18

- To Set PSK Rate ..... 5-18
- To Set PSK Phase..... 5-19
- To Set Modulating Polarity ..... 5-19
- BPSK ..... 5-20
  - To Select BPSK Modulation ..... 5-20
  - To Select Carrier Waveform Shape..... 5-20
  - To Set Carrier Phase ..... 5-20
  - To Select Modulating Waveform Source..... 5-21
  - To Set BPSK Rate..... 5-21
  - To Set BPSK Phase..... 5-22
- QPSK ..... 5-23
  - To Select QPSK Modulation ..... 5-23
  - To Select Carrier Waveform Shape..... 5-23
  - To Set Carrier Phase ..... 5-23
  - To Select Modulating Waveform Source..... 5-24
  - To Set QPSK Rate ..... 5-24
  - To Set QPSK Phases..... 5-24
- 3FSK..... 5-25
  - To Select 3FSK Modulation..... 5-25
  - To Select Carrier Waveform Shape..... 5-25
  - To Set Carrier Frequency ..... 5-25
  - Modulation Source ..... 5-26
  - To Set 3FSK Rate..... 5-26
  - To Set Hop Frequencies..... 5-26
- 4FSK..... 5-27
  - To Select 4FSK Modulation..... 5-27
  - To Select Carrier Waveform Shape..... 5-27
  - To Set Carrier Frequency ..... 5-27
  - Modulation Source ..... 5-28
  - To Set 4FSK Rate..... 5-28
  - To Set Hop Frequencies..... 5-28
- OSK..... 5-29
  - To Select OSK Modulation..... 5-29
  - To Select Carrier Waveform Shape..... 5-30
  - To Set Carrier Frequency ..... 5-30
  - To Select Modulating Waveform Source..... 5-30
  - To Set OSK Rate ..... 5-31



To Set Oscillate Period .....	5-31
PWM .....	5-32
To Select PWM Modulation .....	5-32
To Select Carrier Waveform Shape .....	5-32
To Set Pulse Width/Duty Cycle .....	5-32
To Select Modulating Waveform Source .....	5-33
To Set Modulating Waveform Frequency .....	5-33
To Set Pulse Width/Duty Cycle Deviation .....	5-34
<b>Chapter 6 Sweep .....</b>	<b>6-1</b>
To Enable Frequency Sweep .....	6-2
Start Frequency and End Frequency .....	6-2
Center Frequency and Frequency Span .....	6-3
Sweep Type .....	6-4
Linear Sweep .....	6-4
Log Sweep .....	6-5
Step Sweep .....	6-6
Sweep Time .....	6-7
Return Time .....	6-8
Mark Frequency .....	6-8
Start Hold .....	6-9
End Hold .....	6-10
Sweep Trigger Source .....	6-10
Trigger Output Edge .....	6-11
<b>Chapter 7 Burst .....</b>	<b>7-1</b>
To Enable Burst Mode .....	7-2
Burst Type .....	7-2
N Cycle Burst .....	7-2
Infinite Burst .....	7-3
Gated Burst .....	7-4
Burst Phase .....	7-6
Burst Period .....	7-6
Gated Polarity .....	7-6
Burst Delay .....	7-7
Burst Trigger Source .....	7-7
Trigger Output Edge .....	7-8
<b>Chapter 8 Counter .....</b>	<b>8-1</b>

To Enable the Counter .....	8-2
To Set the Counter .....	8-3
Statistic .....	8-5
<b>Chapter 9 Store and Recall .....</b>	<b>9-1</b>
Storage System Overview .....	9-2
To Select File Type .....	9-4
To Select Browser Type.....	9-5
File Operation .....	9-6
Save.....	9-6
Recall .....	9-8
Copy .....	9-9
Paste.....	9-9
Delete .....	9-9
New Directory .....	9-10
<b>Chapter 10 Utility and System Settings .....</b>	<b>10-1</b>
Overview.....	10-2
Channel Setting .....	10-3
Sync.....	10-3
Sync Polarity .....	10-4
Output Polarity .....	10-5
Resistance Setting .....	10-5
Noise Setting.....	10-6
Noise Scale .....	10-6
To Use the External Power Amplifier (Option) .....	10-7
To Configure the Remote Interface .....	10-12
LAN Setting.....	10-12
To Set USB Device Type .....	10-17
System Setting.....	10-18
Number Format .....	10-18
Language .....	10-19
Power On Setting.....	10-19
Power Setting.....	10-19
Brightness .....	10-20
Beeper .....	10-20
Screen Saver.....	10-20
Clock Source .....	10-20

---

System Information.....	10-22
Print.....	10-23
Test/Cal.....	10-25
Channel Coupling .....	10-26
Channel Copy.....	10-29
User-defined Waveform Key .....	10-30
Restore Default .....	10-32
<b>Chapter 11 Remote Control.....</b>	<b>11-1</b>
Remote Control Overview.....	11-2
Remote Control Mode .....	11-3
User-defined Programming .....	11-3
To Use PC Software.....	11-7
<b>Chapter 12 Troubleshooting.....</b>	<b>12-1</b>
<b>Chapter 13 Specifications.....</b>	<b>13-1</b>
<b>Chapter 14 Appendix.....</b>	<b>14-1</b>
Appendix A: Options and Accessories .....	14-1
Appendix B: Power Amplifier Specifications.....	14-2
Appendix C: Warranty .....	14-4
Appendix D: Any Comment or Question? .....	14-5
<b>Index .....</b>	<b>1</b>



# Chapter 1 Quick Start

This chapter introduces the front/rear panel, user interface and parameter setting method, as well as announcements during first use of the instrument.

Subjects in this chapter:

- General Inspection
- To Adjust the Supporting Legs
- Dimensions
- Front Panel
- Rear Panel
- To Connect to Power
- User Interface
- Parameter Setting Method
- To Use the Built-In Help
- To Use the Security Lock
- To Use the Rack Mount Kit

## General Inspection

### 1. Inspect the shipping container for damage.

If there are damages in the container or foam, keep them until the whole machine and the accessories pass the electrical and mechanical tests.

If your instrument has damaged during shipping, please contact your shipper and carrier for compensation. **RIGOL** will provide no free repair or replacement.

### 2. Inspect the instrument.

In case of any mechanical damage or defect, or if the instrument does not operate properly or pass the electrical and mechanical tests, contact your local sales representative of **RIGOL**.

### 3. Check the Accessories

If the contents are incomplete or damaged, please contact your local sales representative of **RIGOL**.

## To Adjust the Supporting Legs

DG4000 allows users to unfold the supporting legs as stands to tilt the generator upwards for easier operation and observation during operation (as shown in Figure 1-1). Users can fold the supporting legs for easier storage or carry when the instrument is not in use (as shown in Figure 1-2).

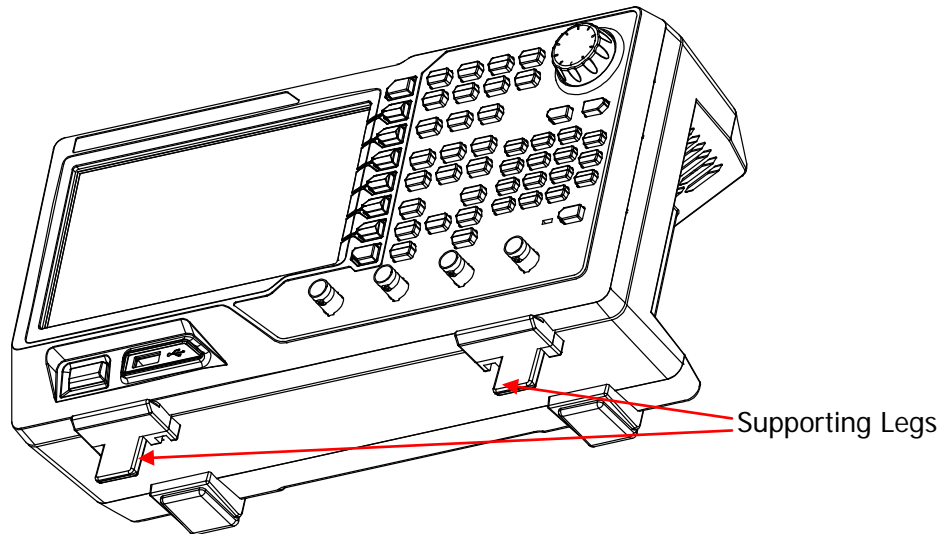

Figure 1-1 Unfold the Supporting Legs

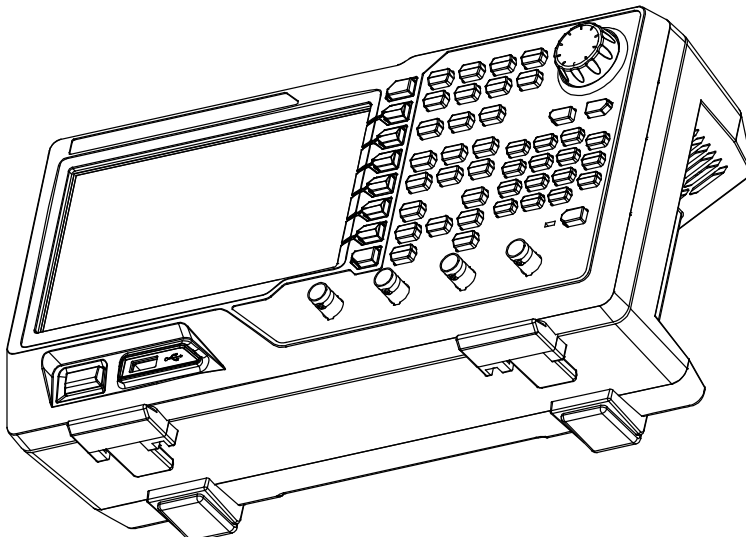

Figure 1-2 Fold the Supporting Legs

## Appearance and Dimensions

The appearance and dimensions of DG4000 are as shown in Figure 1-3 and Figure 1-4 and the unit is mm.

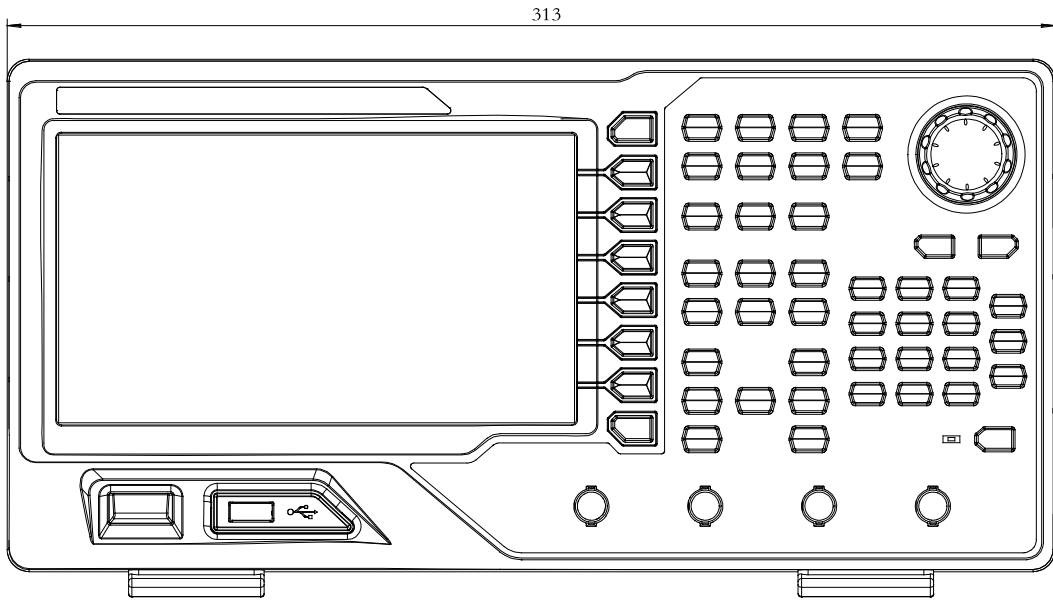

Figure 1-3 Front View



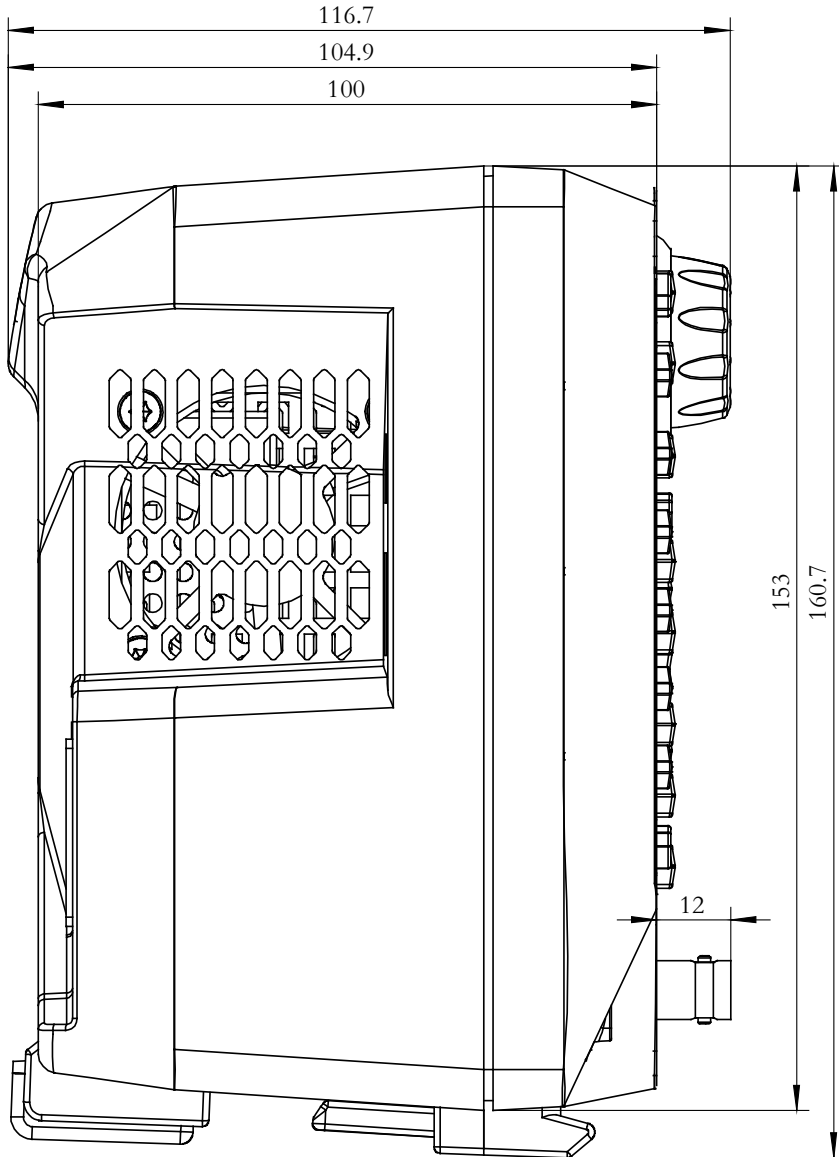

Figure 1-4 Side View

# Front Panel

The front panel of DG4000 is shown below.

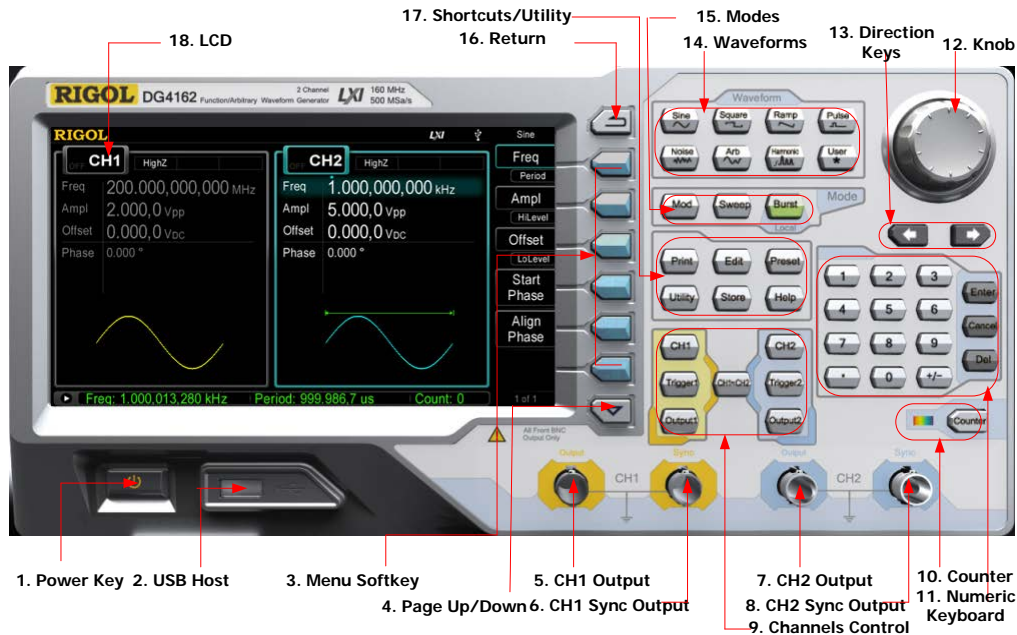

Figure 1-5 DG4000 Front Panel

## 1. Power Key

The power softkey is used to turn the generator on or off. When the power softkey is turned off, the generator is in standby mode and the generator is in power-off mode only when the power cable at the rear panel is pulled out.

Users can enable or disable the function of this softkey. When enabled, users need to press this softkey to start the instrument after power-on; when disabled, the instrument starts automatically after power-on.

## 2. USB Host

Support FAT file format USB storage device. Read the waveform or state files from the USB storage device, or store the current instrument state and edited waveform data into the USB storage device, or store the content currently displayed on the screen in specified picture format (.Bmp or .Jpeg) in USB storage device.

### 3. Menu Softkey

Correspond to the left menus respectively. Press any softkey to activate the corresponding menu.

### 4. Page Up/Down

Open the previous or next page of the current function menu.

### 5. CH1 Output

BNC connector with 50Ω nominal output impedance.

When **Output1** is enabled (the backlight turns on), this connector output waveform according to the current configuration of CH1.

### 6. CH1 Sync Output

BNC connector with 50Ω nominal output impedance.

When the sync output of CH1 is enabled, this connector outputs the sync signal corresponding to the current settings of CH1 (refer to the introduction in **Sync**).

### 7. CH2 Output

BNC connector with 50Ω nominal output impedance.

When **Output2** is enabled (the backlight turns on), this connector output waveform according to the current configuration of CH2.

### 8. CH2 Sync Output

BNC connector with 50Ω nominal output impedance.

When the sync output of CH2 is enabled, this connector outputs the sync signal corresponding to the current settings of CH2 (refer to the introduction in **Sync**).

### 9. Channels Control

**CH1**: used to select CH1. When CH1 is selected (the backlight turns on), users can set the waveform and parameters of CH1.

**CH2**: used to select CH2. When CH2 is selected (the backlight turns on), users can set the waveform and parameters of CH2.

**Trigger1**: in sweep or burst mode, it is used to trigger CH1 to generate a

sweep or burst output manually (only when **Output1** is enabled).

**Trigger2**: in sweep or burst mode, it is used to trigger CH2 to generate a sweep or burst output manually (only when **Output2** is enabled).

**Output1**: enable or disable the output of CH1.

**Output2**: enable or disable the output of CH2.

**CH1=CH2**: execute channel copy (refer to the introductions in **Channel Copy**).

## 10. Counter

Press **Counter** to turn the counter on or off. When the counter is turned on, the backlight of the key is illuminated and the left indicator flickers. If the counter interface is currently displayed, press this key again to disable counter function; if the screen currently displays interfaces other than the counter interface, press this key again to switch to counter interface (refer to the introductions in **Counter**).

## 11. Numeric Keyboard

It is used to input parameters and consists of numbers (0 to 9), decimal point (.), operators (+/-) and buttons ("Enter", "Cancel" and "Del"). If a negative is required, please input an operator "-" before the numbers. In addition, the decimal point "." can be used to switch units quickly and the operators "+/-" can be used to switch between uppercase and lowercase (for the use method of the numeric keyboard, refer to the introduction in **Parameter Setting Method**).

## 12. Knob

During parameter setting, it is used to increase (clockwise) or decrease (counterclockwise) the current highlighted number.

It is used to select file storage location or select the file to be recalled when storing or recalling file.

It is used to switch the character in the soft keyboard when entering filename.

It is used to select built-in waveform when defining the shortcut waveform of

**User**.

### 13. Direction Keys

When using the knob and direction keys to set parameters, the direction keys are used to switch the digits of the number.

During filename input, they are used to move the cursor.

### 14. Waveforms

#### **Sine**----Sine

Generate a Sine waveform with frequency from 1 $\mu$ Hz to 160MHz.

- When the function is enabled, the backlight of the button turns on.
- Enable to change Frequency/Period, Amplitude/High Level, Offset/Low Level and Start Phase of the Sine waveform.

#### **Square**----Square

Generate a Square waveform with frequency from 1 $\mu$ Hz to 50MHz and variable duty cycle.

- When the function is enabled, the backlight of the button turns on.
- Enable to change Frequency/Period, Amplitude/High Level, Offset/Low Level, Duty Cycle and Start Phase of the Square waveform.

#### **Ramp**----Ramp

Generate a Ramp waveform with frequency from 1 $\mu$ Hz to 4MHz and variable symmetry.

- When the function is enabled, the backlight of the button turns on.
- Enable to change Frequency/Period, Amplitude/High Level, Offset/Low Level, Symmetry and Start Phase of the Ramp waveform.

#### **Pulse**----Pulse

Generate a Pulse waveform with frequency from 1 $\mu$ Hz to 40MHz and variable pulse width and edge time.

- When the function is enabled, the backlight of the button turns on.
- Enable to change Frequency/Period, Amplitude/High Level, Offset/Low Level, Pulse Width/Duty Cycle, Leading Edge Time, Trailing Edge Time and Delay of the Pulse waveform.

#### **Noise**----Noise

Generate a Gauss Noise with 120MHz bandwidth.

- When the function is enabled, the backlight of the button turns on.

- Enable to change Amplitude/High Level and Offset/Low Level of the Noise.

### **Arb**----Arbitrary Waveforms

Generate an arbitrary waveform with frequency from 1 $\mu$ Hz to 40MHz.

- Provide point by point output mode.
- Generate 150 built-in waveforms: DC, Sinc, Exponential Rise, Exponential Fall, ECG, Gauss, Haversine, Lorentz, Pulse, Dual-Tone etc.; output arbitrary waveforms stored in USB storage device.
- Generate arbitrary waveforms (16 kpts) edited from the front panel or through PC software and then downloaded to the instrument by the users.
- When the function is enabled, the backlight of the button turns on.
- Enable to change Frequency/Period, Amplitude/High Level, Offset/Low Level and Start Phase of the arbitrary waveform.

### **Harmonic**——Harmonic

Generate harmonics with frequency from 1 $\mu$ Hz to 80MHz.

- Output up to 16<sup>th</sup> order of harmonic.
- Users can set the harmonic "Order", "Type", "Ampl" and "Phase".

### **User**----User-defined Waveform Key

Users can define the frequently used built-in waveform or stored waveform as shortcut (**Utility** → **UserKey**). And then, in any operation interface, press

**User** to quickly open the desired waveform and set its parameters.

## 15. Modes

### **Mod**----Modulation

Generate the modulated waveforms. Provide various analog modulation and digital modulation modes and can generate AM, FM, PM, ASK, FSK, PSK, BPSK, QPSK, 3FSK, 4FSK, OSK or PWM modulated signal.

- Support internal and external modulations.

### **Sweep**----Sweep

Generate the frequency sweeping signal of Sine, Square, Ramp and Arbitrary Waveforms (except DC).

- Support three sweep types: Linear, Log and Step.
- Support three trigger sources: Internal, External and Manual.

- Provide the “Mark” function.
- When the function is enabled, the backlight of the button turns on.

### **Burst**----**Burst**

Generate burst waveforms of Sine, Square, Ramp, Pulse and Arbitrary waveform (except DC).

- Support three burst types: N Cycle, Infinite and Gated.
- Noise can also be used to generate Gated burst.
- Support three trigger sources: Internal, External and Manual.
- When the function is enabled, the backlight of the button turns on.

Note: when the instrument is working in remote mode, you can return it back to local mode by pressing **Burst**.

## 16. Return

This key is used to return to the previous menu.

## 17. Shortcuts/Utility

**Print**: used to execute print function. Save the content shown on the screen as image in USB storage device.

**Edit**: this key is the shortcut of “**Arb** → **Edit Wform**” and is used to enter the ArbEdit interface quickly.

**Preset**: used to return the instrument state to default or user-defined states (refer to the introduction in **Restore Default**).

**Utility**: used to set the system parameters. When this function is enabled, the backlight of the button turns on.

**Store**: store or recall the instrument state or user-defined arbitrary data.

- Support normal file operations.
- Provide a built-in non-volatile memory (C Disk) and an external USB storage device (D Disk).
- When the function is enabled, the backlight of the button turns on.

**Help**: to get context help information about any front-panel key or menu softkey, press this key until it is illuminated and then press the desired key.

## 18. LCD

800 × 480 TFT color LCD is used to display the current function menu and parameters setting, system state as well as prompt messages.



---

### CAUTION

Overvoltage protection of the output channel will take effect once any of the following conditions is met.

- Amplitude setting in the generator is greater than 4Vpp; the input voltage is greater than  $\pm 11.25\text{V}$  ( $\pm 0.1\text{V}$ ) and frequency is lower than 10kHz.
  - Amplitude setting in the generator is lower than or equal to 4Vpp; the input voltage is greater than  $\pm 4.5\text{V}$  ( $\pm 0.1\text{V}$ ) and frequency is lower than 10kHz.
  - The message "OverLoad protect, The output is off!" will appear on the screen when overvoltage protection takes effect.
-



## Rear Panel

The rear panel of DG4000 is as shown in the figure below.



Figure 1-6 DG4000 Rear Panel

### 1. AC Power Input

This generator can accept AC power supply of 100-240V, 45-440Hz.  
Power Fuse: 250V, T2 A.

### 2. LAN

Connect the generator to the local area network for remote control through this interface. This generator conforms to LXI-C instrument standards and can quickly build test system with other devices to easily realize system integration.

### 3. Security Lock Hole

Users can use the security lock (buy it by themselves) to lock the instrument at a fixed location.

#### 4. USB Device

PC can be connected through this interface to control the generator remotely through PC software.

#### 5. 10MHz In/Out

BNC female connector with 50Ω nominal impedance. The function of this connector is determined by the type of clock used by the generator. DG4000 can use internal or external clock (refer to the introduction in **Clock Source** ).

- When internal clock source is used, the connector (used as 10MHz Out) can output 10MHz clock signal generated by the internal crystal oscillator of the generator.
- When external clock source is used, the connector (used as 10MHz In) accepts a 10MHz external clock signal.
- This connector is usually used to synchronize multiple instruments (refer to the introduction in **Sync**).

#### 6. CH1: Mod/FSK/Trig

BNC female connector with 50Ω nominal impedance. Its function is determined by the current working mode of CH1.

- **Mod:**  
If AM, FM, PM, PWM or OSK is enabled for CH1 and external modulation source is used, this connector accepts an external modulation signal.
- **FSK:**  
If ASK, FSK or PSK is enabled for CH1 and external modulation source is used, this connector accepts an external modulation signal (users can set the polarity of the signal).
- **Trig In:**  
If CH1 is in sweep or burst mode and external trigger source is used, this connector accepts an external trigger signal (users can set the polarity of the signal).
- **Trig Out:**  
If CH1 is in sweep or burst mode and internal or manual trigger source is used, this connector outputs a trigger signal with specified edge.

#### 7. CH2: Mod/FSK/Trig

BNC female connector with 50Ω nominal impedance. Its function is determined by the current working mode of CH2.

- **Mod:**  
If AM, FM, PM, PWM or OSK is enabled for CH2 and external modulation source is used, this connector accepts an external modulation signal.
- **FSK:**  
If ASK, FSK or PSK is enabled for CH2 and external modulation source is used, this connector accepts an external modulation signal (users can set the polarity of the signal).
- **Trig In:**  
If CH2 is in sweep or burst mode and external trigger source is used, this connector accepts an external trigger signal (users can set the polarity of the signal).
- **Trig Out:**  
If CH2 is in sweep or burst mode and internal or manual trigger source is used, this connector outputs a trigger signal with specified edge.

#### 8. External Signal Input (Counter)

BNC female connector with 50Ω nominal impedance. It is used to accept an external signal to be measured by the counter.

## To Connect to Power

DG4000 accepts AC power supply: 100 to 240V, 45Hz to 440Hz. Please use the power cable provided in the accessories to connect the instrument to AC power (as shown in Figure 1-7). At this point, the generator is powered on and the power button at the lower-left corner of the front panel is in breathing state.

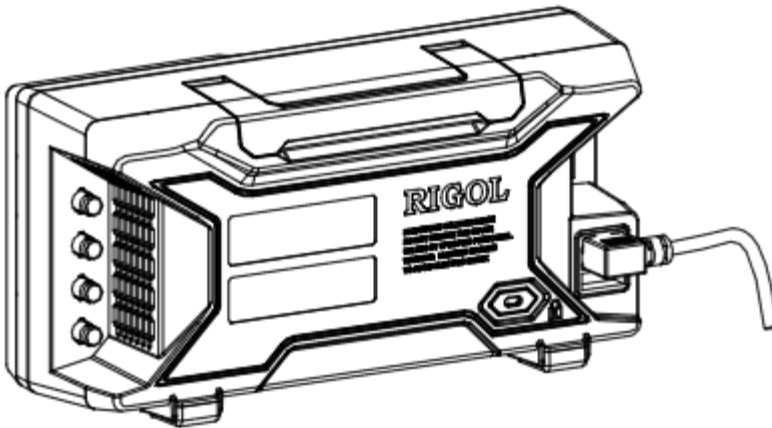

Figure 1-7 To Connect to Power



---

### CAUTION

If the power fuse needs to be changed, please return the instrument back to our factory and the **RIGOL** authorized operator will change it for you.

---

## User Interface

DG4000 user interface displays the parameters and waveforms of the two channels at the same time. The figure below is the interface when both CH1 and CH2 select Sine. Different contents will be displayed when different functions are enabled.

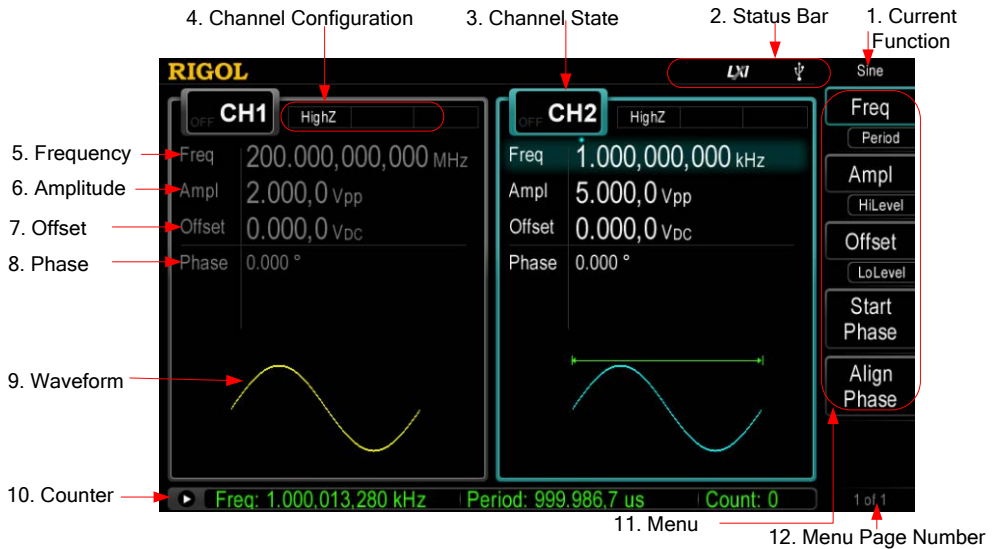





Figure 1-8 User Interface

### 1. Current Function

Display the name of the function currently selected. For example, "Sine" indicates that "Sine" waveform function is currently selected and "ArbEdit" indicates that "Arbitrary Waveform Edit" function is currently selected.

### 2. Status Bar

The following indicators would be displayed according to the current configuration.

-  When the instrument is connected into LAN successfully, this indicator will light.
-  When the generator works in remote mode, this indicator will light.
-  When the generator detects connected USB storage device, this indicator will light.

### 3. Channel Status

Display areas of CH1 and CH2. Indicate whether the channel is selected and turned on (ON/OFF). The area of the channel currently selected is highlighted and the on/off state of the channel currently turned on is "ON".

#### Note:

When a channel is "Selected", it does not mean that the channel is turned on. When CH1 is selected, users can configure the parameters of CH1 and the backlight of **CH1** turns on. When CH1 is turned on, CH1 can output waveform according to the current configuration and the backlight of **Output1** turns on.

### 4. Channel Configurations

Display the current output configuration in each channel, including output resistance, mode and type of modulating source or trigger source.

- **Output Resistance**

High Impedance: display "HighZ"

Load: display the resistance value, the default is "50Ω"

- **Mode**

Modulation: display "Mod"

Sweep: display "Sweep"

Burst: display "Burst"

- **Modulating/Trigger Source Type**

Internal modulating/trigger: display "Internal"

External modulating/trigger: display "External"

Manual Trigger: display "Manual"

### 5. Frequency

Display the current waveform frequency in each channel. Press the corresponding softkey **Freq** and use the numeric keyboard or direction keys and knob to modify this parameter. The parameter that can be modified currently will be highlighted and the lightspot above the number indicates current cursor location.

### 6. Amplitude

Display the current waveform amplitude in each channel. Press the corresponding softkey **Ampl** and use the numeric keyboard or direction keys and knob to modify this parameter. The parameter that can be modified

currently will be highlighted and the lightspot above the number indicates current cursor location.

## 7. Offset

Display the current waveform DC offset in each channel. Press the corresponding softkey **Offset** and use the numeric keyboard or direction keys and knob to modify this parameter. The parameter that can be modified currently will be highlighted and the lightspot above the number indicates current cursor location.

## 8. Phase

Display the current waveform phase in each channel. Press the corresponding softkey **Start Phase** and use the numeric keyboard or direction keys and knob to modify this parameter. The parameter that can be modified currently will be highlighted and the lightspot above the number indicates current cursor location.

## 9. Waveform

Display the currently selected waveform shape in each channel.

## 10. Counter

Only available when the counter is turned on and can display the current measurement state of the counter briefly or in detail.

- Brief: only display frequency, period and the number of measurements performed.
- Detail: display the configurations of the counter, five measurement values (Frequency, Period, Duty Cycle, Positive Pulse Width and Negative Pulse Width) and the number of measurements performed.

## 11. Menu

Display the operation menu corresponding to the function currently selected. For example, the "Sine" function menu is displayed in the above figure.

## 12. Menu Page Number

Display the total number of pages and the current page number of the menu, such as "1 of 1" or "1 of 2".

## Parameter Setting Method

Users can use the numeric keyboard or knob and direction keys to set parameters.

### Numeric Keyboard



The numeric keyboard consists of:

- **Number Keys**

The 0 to 9 number keys are used to directly input the desired parameter value.

- **Decimal Point**

Press this key to insert a decimal point "." at the current position of the cursor.

- **Operator Key**

The operator key "+/-" is used to modify the operator of the parameter. Press this key to set the parameter operator to "-"; press this key again to switch the operator to "+". Note that the operator key is used to switch between uppercase and lowercase in filename edit.

- **Enter Key**

Press this key to finish parameter input and add the default unit for the parameter.

- **Cancel Key**

- (1) During parameter input, press this key to clear the input in the active function area and exit parameter input.
- (2) Turn the display in the active function area off.

- **Del Key**

- (1) During parameter input, press this key to delete the character at the left of the cursor.
- (2) During filename edit, press this key to delete the characters input.



## Direction keys and Knob



Functions of the direction keys:

1. During parameter input, use the direction keys to move the cursor to select the digit to be edited.
2. During filename edit, use the direction keys to move the cursor.



Functions of the knob:

- When the parameter is in editable state, turn the knob to increase (clockwise) or reduce (counterclockwise) the parameter with specified step.
- During filename edit, use the knob to select the characters in the soft keyboard.
- In **Arb** → **Select Wform** → **BuiltIn** and **Utility** → **UserKey**, use the knob to select arbitrary waveform.
- In store and recall, use the knob to select the storage location of the file or to select the file to be recalled.

## To Use the Built-In Help

To get context help information about any front-panel key or menu softkey, press **Help** to illuminate the key and then press the desired key to get corresponding help.

Pressing **Help** twice will get the following common help.

1. **View the last displayed message.**
2. **View error queue of the remote commands.**
3. **Get the help information of a key.**
4. **Generate a basic waveform.**
5. **Generate an arbitrary waveform.**
6. **Generate a modulated waveform.**
7. **Generate a frequency Sweep.**
8. **Generate a Burst waveform.**
9. **Storage management.**
10. **Synchronize multiple Generators.**
11. **Seamlessly connected with the RIGOL DS.**
12. **Get technical support from RIGOL.**

## To Use the Security Lock

Use the security lock (option) to lock the generator at a fixed location. As shown in the figure below, align the lock with the lock hole and plug it into the lock hole vertically, turn the key clockwise to lock the instrument and then pull the key out.



Figure 1-9 Security Lock Hole

## To Use the Rack Mount Kit

This instrument can be installed into a standard 19 inches cabinet.

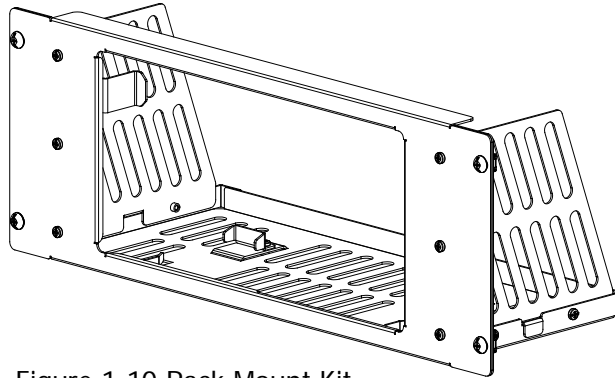

Figure 1-10 Rack Mount Kit

## Kit Parts List

The part list of the rack mount kit (as shown in Figure 1-10) of DG4000 is as shown in the table below. Wherein, the “No.” column corresponds to Figure 1-11 and Figure 1-12.

Table 1-1 Kit Parts List

No.	Name	Qty	Part No.	Description
1-1	Front Panel	1	RM-DG4-01	
1-2	Support Board	1	RM-DG4-02	
1-3	Left Plate	1	RM-DG4-03	
1-4	Right Plate	1	RM-DG4-04	
1-5	Pressure Feet	2	RM-DG4-05	
1-6	Built-in Fitting	2	RM-DG4-06	
2-1	M4 Screw	18	RM-SCREW-01	M4 x 6 Phil-Slot Pan Head Machine Screw Nail
2-2	M6 Screw	4	RM-SCREW-02	M6 x 20 Phil-Slot Pan Head Machine Screw Nail
2-3	M6 Screw	4	RM-SCREW-03	M6 x 4 Square Machine Female Screw Contain Lock Blade

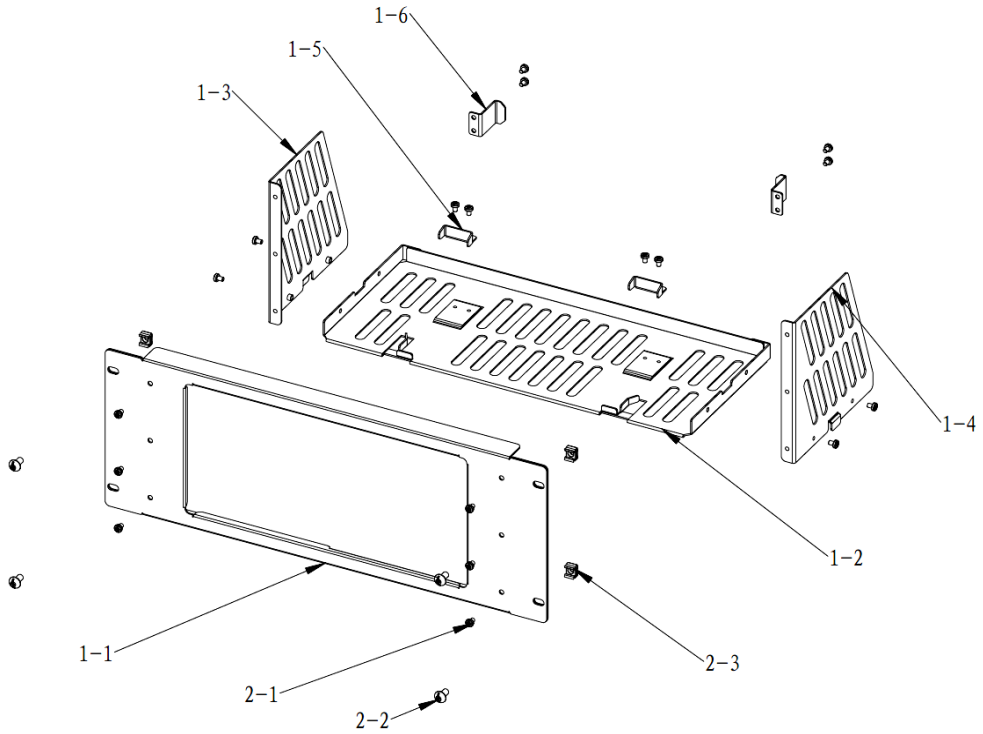

Figure 1-11 Parts of Rack Mount Kit

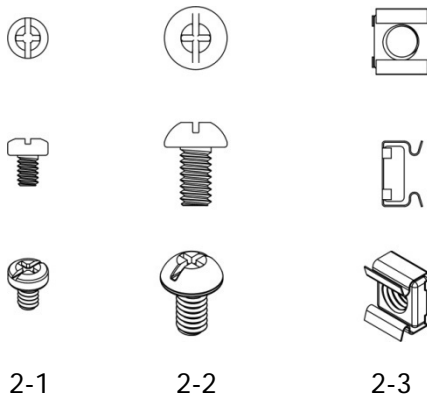

Figure 1-12 Screws and Nuts

## Installation Tool

PH2 Phillips Screwdriver (recommended).

## Installation Space

The following requirements must be fulfilled by the machine cabinet in which the instrument is mounted.

- The machine cabinet must be a standard 19-inch one.
- At least 4U (177.8 mm) space should be provided by the machine cabinet.
- The depth inside the machine cabinet should not be less than 180 mm.

The dimension of the instrument after being installed is as shown below.

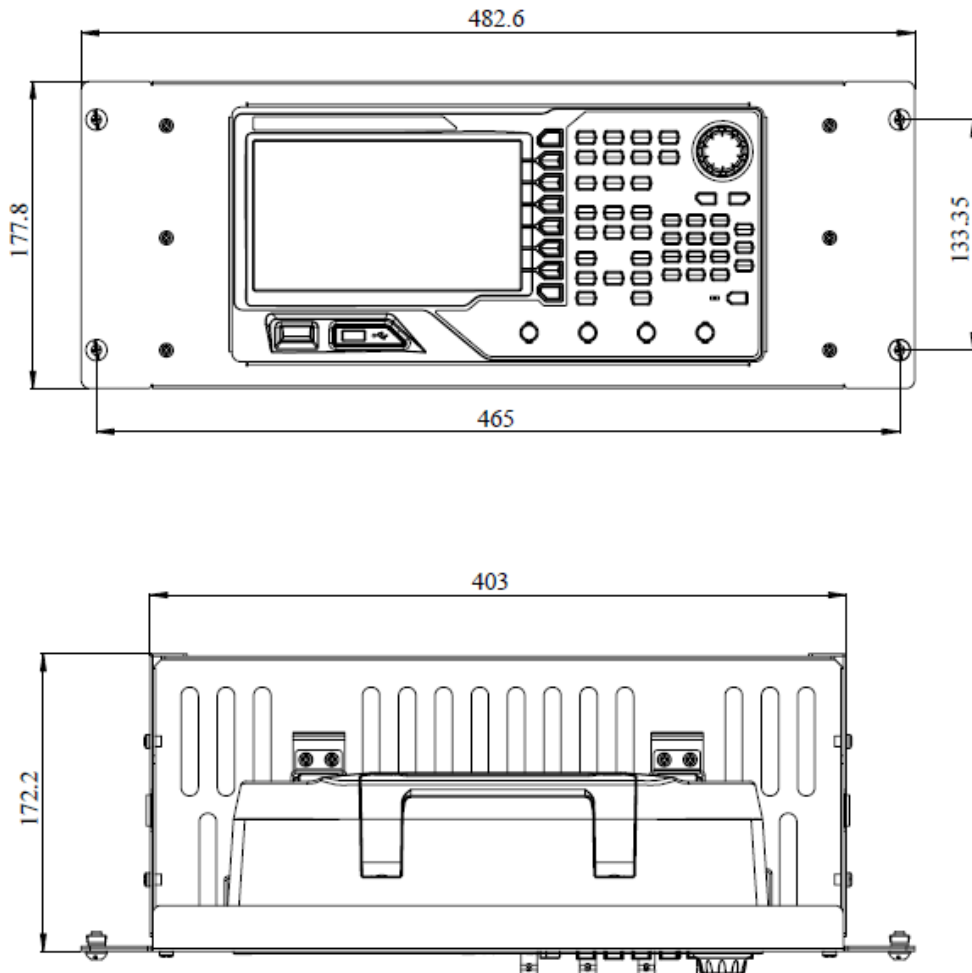

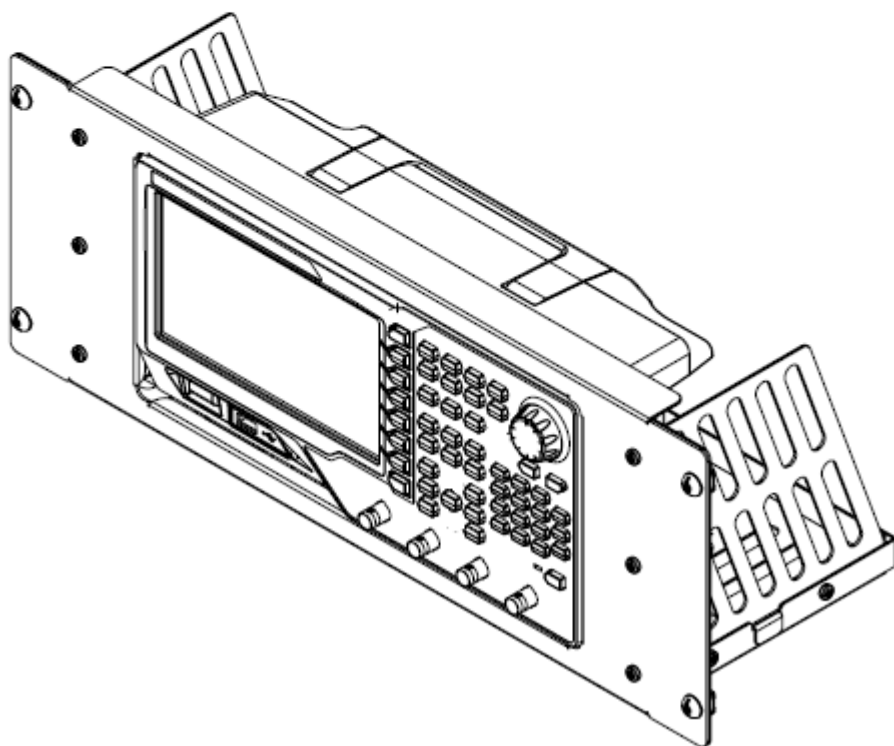
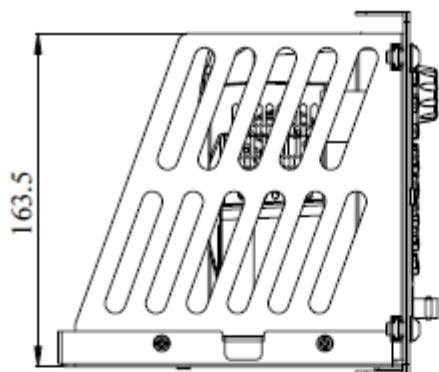

## Installation Procedure

Only authorized operators can execute the installation operation. Improper installation might result in damage of the instrument or incorrect installation of the instrument on the rack.

1. Install the right and left plates: align the detents of the right and left plates with the openings on the support board and insert them into the support board respectively, then fix them with four M4 screws.

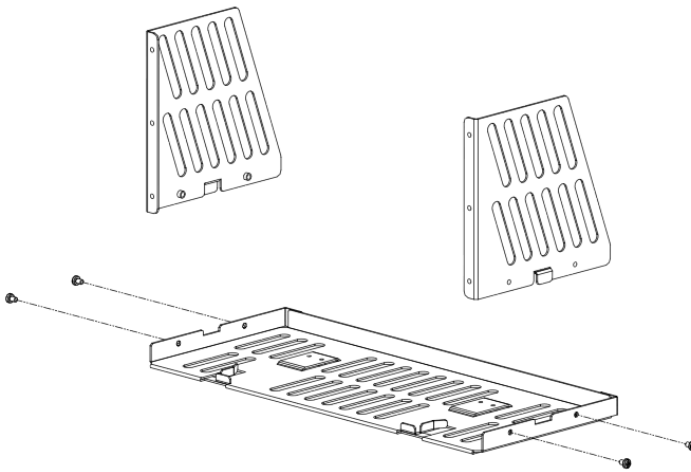

2. Install the front panel of the rack mount kit: fix the front panel onto the frame installed in the previous step using six M4 screws.

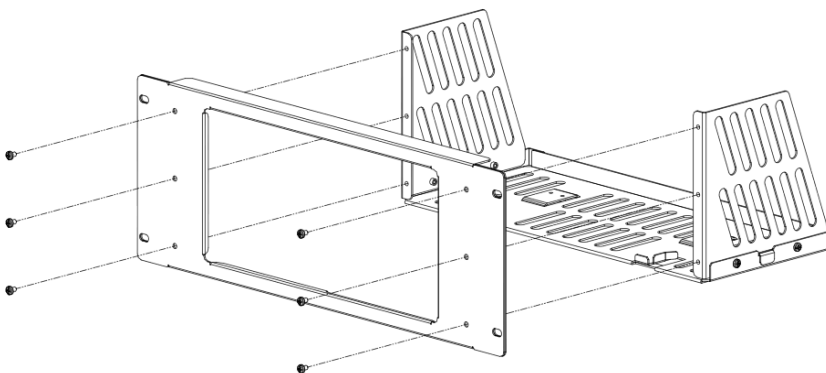



3. Fix the bottom of the instrument: fix the instrument onto the support board using two pressure feet and four M4 screws.

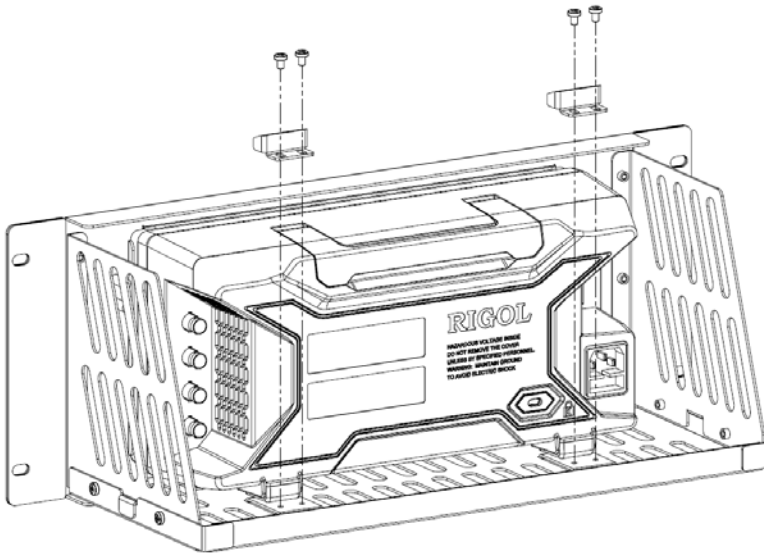

4. Fix the top of the instrument: fix the top of the instrument using two built-in fittings and four M4 screws.

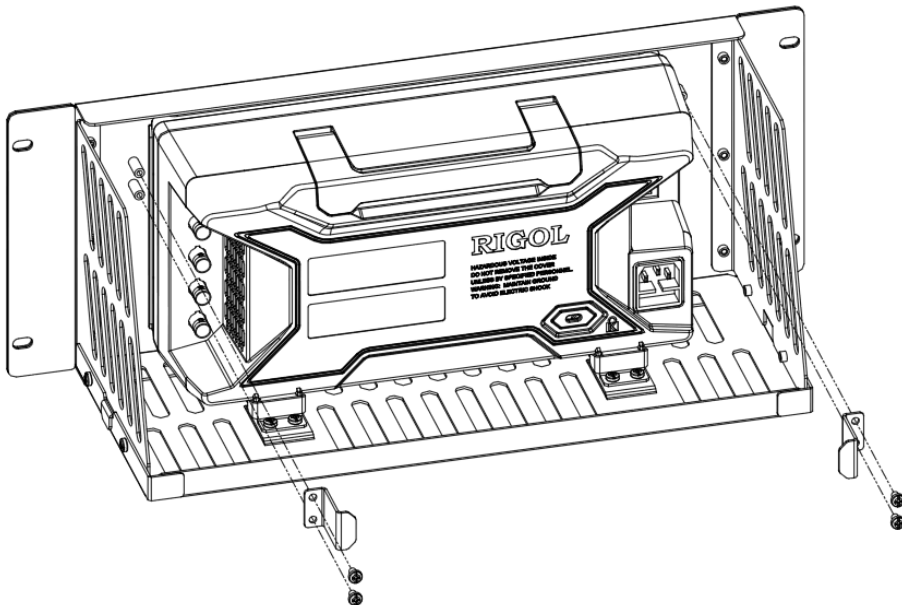

5. Load into the machine cabinet: mount the rack with the instrument fixed to it into a standard 19-inch machine cabinet with four M6 screws and four M6 square nuts.

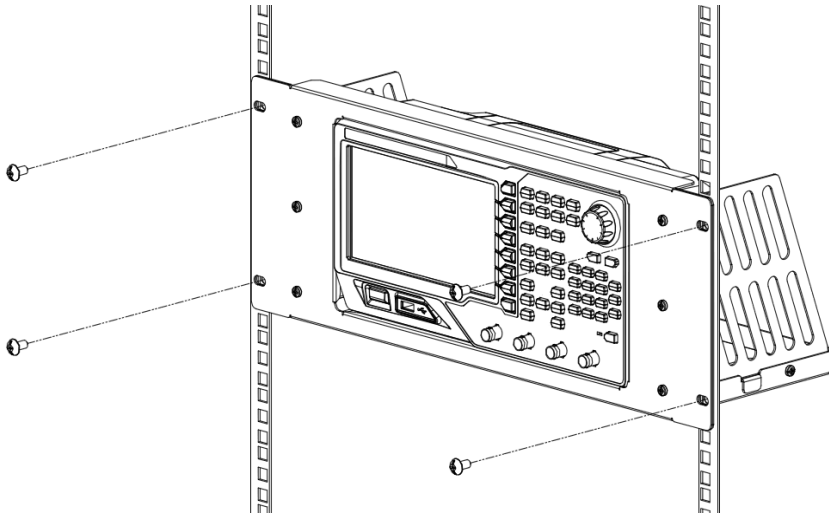

6. Post-installation notice: the rack occupies a height of 4U. The holes pointed out by the arrows are installation holes. Note that they should be aligned with during installation.

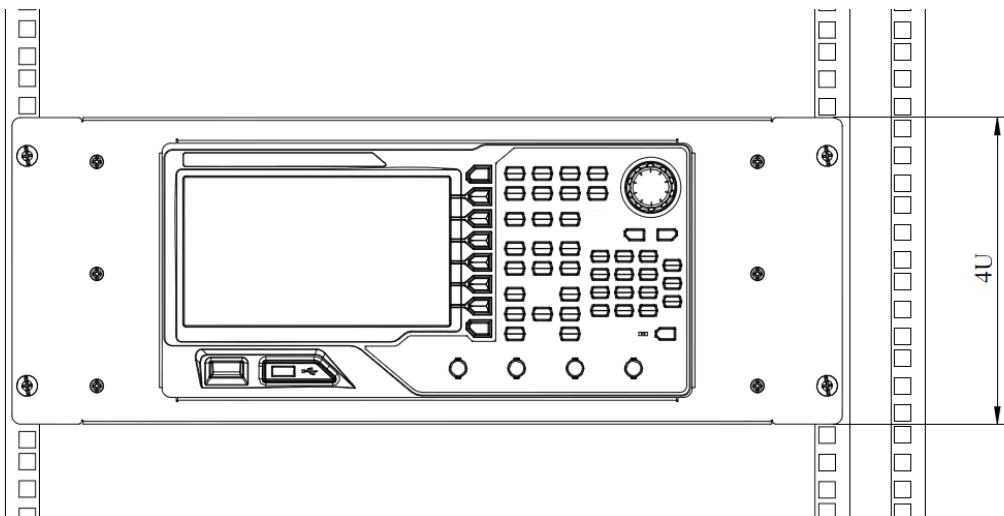

## Chapter 2 Basic Waveform Output

DG4000 can output basic waveforms (including Sine, Square, Ramp, Pulse and Noise) from one of the channels separately or from the two channels at the same time. At start-up, the instrument outputs a sine waveform with 1kHz frequency and 5Vpp amplitude by default. This chapter introduces how to configure the instrument to output various basic waveforms.

Subjects in this chapter:

- To Select Output Channel
- To Select Basic Waveform
- To Set Frequency
- To Set Amplitude
- To Set DC Offset Voltage
- To Set Start Phase
- Align Phase
- To Set Duty Cycle
- To Set Symmetry
- To Set Parameters for Pulse
- To Enable Output
- Basic Waveform Output Example

## To Select Output Channel

Users can configure DG4000 to output basic waveform from a single channel or from dual channels at the same time. Please select the desired channel before configuring waveform parameters. At start-up, CH1 is selected by default.

Press **CH1** or **CH2** at the front panel and the corresponding area in the user interface is illuminated. At this point, users can configure the waveform and parameters of the channel selected.

Note: CH1 and CH2 can not be selected at the same time. Users can first select CH1 and then select CH2 after configuring the waveform and parameters of CH1.

## To Select Basic Waveform

DG4000 can output 5 kinds of basic waveforms including Sine, Square, Ramp, Pulse and Noise. At start-up, Sine is selected by default.

### 1. Sine

Press **Sine** at the front panel to select sine waveform and the backlight of the button turns on. At this point, "Sine" and the parameter setting menu of sine waveform are displayed on the right of the user interface.

### 2. Square

Press **Square** at the front panel to select square waveform and the backlight of the button turns on. At this point, "Square" and the parameter setting menu of square waveform are displayed on the right of the user interface.

### 3. Ramp

Press **Ramp** at the front panel to select ramp waveform and the backlight of the button turns on. At this point, "Ramp" and the parameter setting menu of ramp waveform are displayed on the right of the user interface.

### 4. Pulse

Press **Pulse** at the front panel to select pulse and the backlight of the button turns on. At this point, "Pulse" and the parameter setting menu of pulse are displayed on the right of the user interface.

### 5. Noise

Press **Noise** at the front panel to select noise and the backlight of the button turns on. At this point, "Noise" and the parameter setting menu of noise are displayed on the right of the user interface.

## To Set Frequency

Frequency is one of the most important parameters of basic waveforms. For different instrument models and different waveforms, the setting ranges of frequency are different. For detailed information, please refer to “Frequency Characteristics” in **Specifications**. The default frequency is 1kHz.

The frequency displayed on the screen is the default value or the frequency previously set. When the instrument function is changed, if this frequency is valid under the new function, the instrument will still use this frequency; otherwise, the instrument would display prompt message and set the frequency to the frequency upper limit of the new function automatically.

Press **Freq/Period** to highlight “Freq”. At this point, use the numeric keyboard or direction keys and knob to input the frequency value. Then, select the desired unit from the pop-up menu.

- For the input method of frequency value, refer to the introduction in **Parameter Setting Method**.
- The frequency units available are MHz, kHz, Hz, mHz and  $\mu$ Hz.
- Press this softkey again to switch to period setting. At this point, “Period” is highlighted.
- The period units available are sec, msec,  $\mu$ sec and nsec.

## To Set Amplitude

The amplitude range is limited by the “**Resistance**” and “**Freq/Period**” settings. Please refer to “Output Characteristics” in **Specifications**. The default value is 5Vpp.

The amplitude displayed on the screen is the default value or the amplitude previously set. When the instrument configuration (such as frequency) is changed, if this amplitude is valid, the instrument will still use this amplitude; otherwise, the instrument would display prompt message and set the amplitude to the amplitude upper limit of the new configuration automatically. Users can also use “High Level” or “Low Level” to set the amplitude.

Press **Ampl/HiLevel** to highlight “Ampl”, and then use the numeric keyboard or direction keys and knob to input the amplitude value. Then, select the desired unit from the pop-up menu.

- For the input method of amplitude value, refer to the introduction in **Parameter Setting Method**.
- The amplitude units available are Vpp, mVpp, Vrms, mVrms and dBm (valid in HighZ).
- Press this softkey again to switch to high level setting. At this point, “HiLevel” is highlighted.
- The high level units available are V and mV.

### Unit Switch

Vpp is the unit for signal peak-peak value and Vrms is the unit for signal effective value. The default unit is Vpp. Users can quickly switch the current amplitude unit from the front panel.

For different waveforms, the relations between Vpp and Vrms are different. The relation of the two units is as shown in the figure below (take sine waveform as an example).

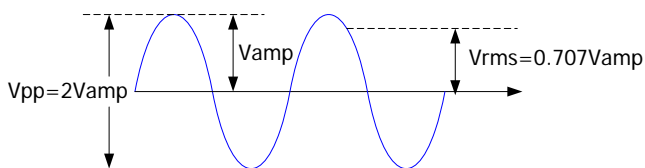

According to the figure above, the conversion relation between Vpp and Vrms fulfills the following equation:

$$V_{pp} = 2\sqrt{2}V_{rms}$$

For example, to convert 2Vpp to the corresponding value in Vrms, press  in the numeric keyboard and select Vrms menu. For sine waveform, the converted value is 707.2mVrms.



## To Set DC Offset Voltage

The DC offset range is limited by the "**Resistance**" and "**Ampl/HiLevel**" settings. Please refer to the "Output Characteristics" in **Specifications**. The default value is  $0V_{DC}$ .

The DC offset voltage displayed on the screen is the default value or the offset previously set. When the instrument configuration (such as resistance) is changed, if this offset is valid, the instrument will still use this offset; otherwise, the instrument would display prompt message and set the offset to the offset upper limit of the new configuration automatically.

Press **Offset/LoLevel** to highlight "Offset", and then use the numeric keyboard or direction keys and knob to input the offset value. Then, select the desired unit from the pop-up menu.

- For the input method of offset value, refer to the introduction in **Parameter Setting Method**.
- The DC offset voltage units available are  $V_{DC}$  and  $mV_{DC}$ .
- Press this softkey again to switch to low level setting. At this point, "LoLevel" is highlighted.
- The low level units available are V and mV.

## To Set Start Phase

The setting range of start phase is from  $0^{\circ}$  to  $360^{\circ}$  and the default is  $0^{\circ}$ .

The start phase displayed on the screen is the default value or the phase previously set. When the instrument function is changed, the new function will still use this phase.

Press **Start Phase** to highlight the softkey, and then use the numeric keyboard or direction keys and knob to input the start phase value. Then, select the unit “ $^{\circ}$ ” from the pop-up menu. For the input method of phase value, refer to the introduction in **Parameter Setting Method**.

## Align Phase

DG4000 series dual-channel generators enable to align the phases of the two channels. Pressing down this softkey will re-configure the two channels, and enable the generator to output with specified frequency and start phase.

For two signals whose frequencies are the same or in multiple, this operation will align their phases. For example, assume a sine waveform (1kHz, 5Vpp, 0°) is output from CH1, while another (1kHz, 5Vpp, 180°) from CH2. Use an oscilloscope to sample and display the two signals, and then toggle the channel output switch of the generator, you will see that the waveforms shown on the oscilloscope do not always have a phase deviation of 180°. At this point, press **Align Phase** on the generator and the waveforms shown on the oscilloscope will have a phase deviation of 180° without any adjustment of the start phase of the generator.

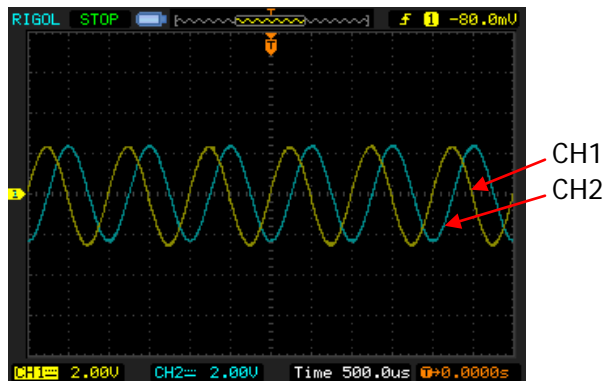

Figure 2-1 Before Aligning Phase

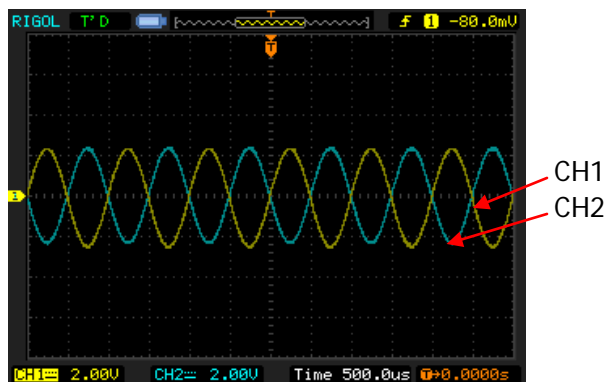
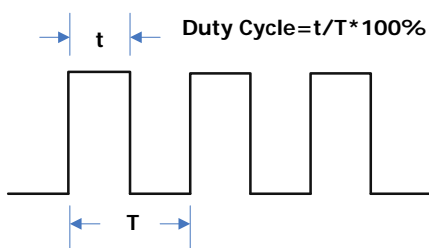

Figure 2-2 After Aligning Phase

**Note:** the **Align Phase** menu is grayed out and disabled when one of the two channels is in modulation mode.

## To Set Duty Cycle

Duty Cycle is defined as the percentage that the high level takes up in the whole period as shown in the figure below. This parameter is only available when square waveform is selected.



The duty cycle range is limited by the “**Freq/Period**” setting. Please refer to “Signal Characteristics” in **Specifications**. The default value is 50%.

Press **Duty Cycle** to highlight the softkey, and then use the numeric keyboard or direction keys and knob to input the duty cycle value. Then, select the unit “%” from the pop-up menu. For the input method of duty cycle value, refer to the introduction in **Parameter Setting Method**.

## To Set Symmetry

Symmetry is defined as the percentage that the rising period takes up in the whole period as shown in the figure below. This parameter is only available when ramp is selected.

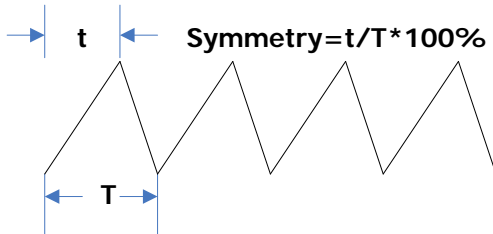

The setting range of symmetry is from 0% to 100% and the default is 50%.

Press **Symmetry** to highlight the softkey, and then use the numeric keyboard or direction keys and knob to input the symmetry value. Then, select the unit “%” from the pop-up menu. For the input method of symmetry value, refer to the introduction in **Parameter Setting Method**.

## To Set Parameters for Pulse

To output a pulse, users need to set the “Pulse Width/Duty Cycle”, “Leading edge”, “Trailing edge”, “Delay” and “Recover Delay” in addition to the basic parameters (such as frequency, amplitude, DC offset voltage, start phase, high level, low level and align phase) introduced above.

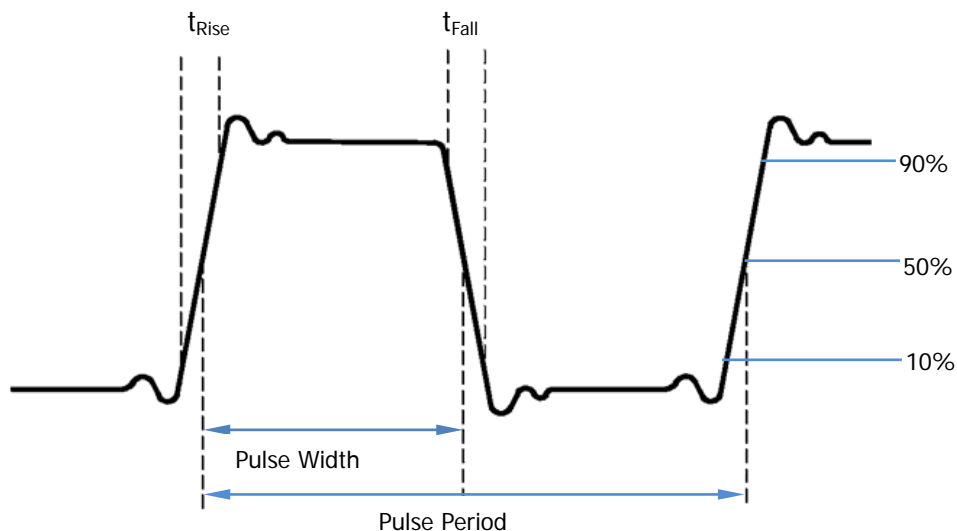

### Pulse Width/Duty Cycle

Pulse Width is defined as the time from the 50% threshold of a rising edge amplitude to the 50% threshold of the next falling edge amplitude as shown in the figure above.

Pulse Width range is limited by the “**Minimum Pulse Width**” and the “**Pulse Period**” (for the ranges of “Minimum Pulse Width” and “Pulse Period”, please refer to “Signal Characteristics” in **Specifications**). The default value is 500 $\mu$ s.

- Pulse Width  $\geq$  Minimum Pulse Width
- Pulse Width  $\leq$  Pulse Period - Minimum Pulse Width  $\times$  2

Pulse Duty Cycle is defined as the percentage that the Pulse Width takes up in the whole period.

Pulse Width and Duty Cycle are correlative. Once a parameter is changed, the other will be automatically changed. Pulse Duty Cycle is limited by the “**Minimum Pulse Width**” and the “**Pulse Period**”.

- Pulse Duty Cycle  $\geq 100 \times \text{Minimum Pulse Width} \div \text{Pulse Period}$
- Pulse Duty Cycle  $\leq 100 \times (1 - 2 \times \text{Minimum Pulse Width} \div \text{Pulse Period})$

Press **Width/Duty** to highlight “Width”, and use the numeric keyboard or direction keys and knob to input the desired value. Then, select the desired unit from the pop-up menu.

- For the input method of the value, refer to the introduction in **Parameter Setting Method**.
- Selectable Pulse Width units: sec, msec,  $\mu$ sec, nsec.
- Press this softkey again to switch to duty cycle setting (at this point, it is set to 20% automatically).

## Leading/Trailing Edge Time

The Leading (rising) edge time is defined as the duration of the pulse amplitude rising from 10% to 90% threshold, while the Trailing (falling) edge time is defined as the duration of the pulse amplitude moving down from 90% to 10% threshold as shown in the figure above.

The range of leading/trailing edge time is limited by the currently specified pulse width limit as shown in the formula below. DG4000 will automatically adjust the edge time to match the specified pulse width if the value currently set exceeds the limit value.

$$\text{Leading/Trailing Edge Time} \leq 0.625 \times \text{Pulse Width}$$

Press **Leading** (or **Trailing**) to highlight the softkey. Use the numeric keyboard or direction keys and knob to input the desired value and select the desired unit from the pop-up menu.

- For the input method of the value, refer to the introduction in **Parameter Setting Method**.
- Selectable Leading/Trailing Edge Time units: sec, msec,  $\mu$ sec, nsec.
- Leading edge time and trailing edge time are independent from each other and users can set them separately.



## Delay

Delay is defined as the delayed time of the output of a channel relative to the output of the other channel. The range of delay is from 0s to pulse period and the default is 0s.

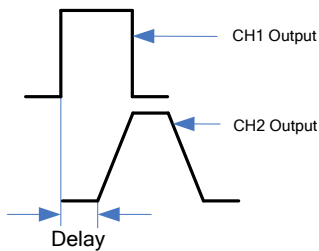

Press **Delay** to highlight the softkey. Use the numeric keyboard or direction keys and knob to input the desired value and select the desired unit from the pop-up menu.

- For the input method of the value, refer to the introduction in **Parameter Setting Method**.
- Selectable Delay Time units: sec, msec,  $\mu$ sec, nsec.

## Recover Delay

Press **Pulse**, then use  to open the 2/2 menu page and press **Restore**, the generator will align the delay between the two channels. Assume that CH1 and CH2 output pulse waveforms with the same parameters. Use the oscilloscope to sample the waveforms of the two channels and display them stably. Then, toggle the output switch of the generator. The two waveforms displayed on the oscilloscope have a certain delay. At this point, press **Restore** on the generator and the waveforms will be displayed on the oscilloscope without any delay.

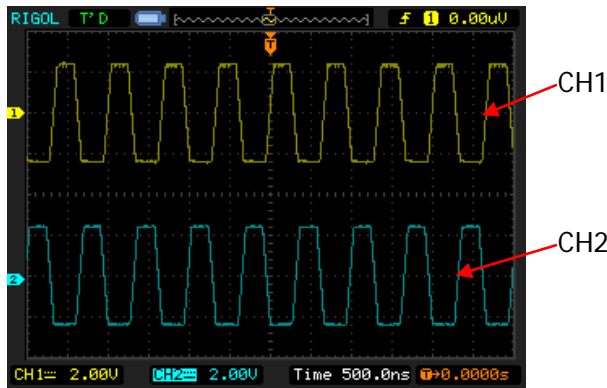

Figure 2-3 Before Restore

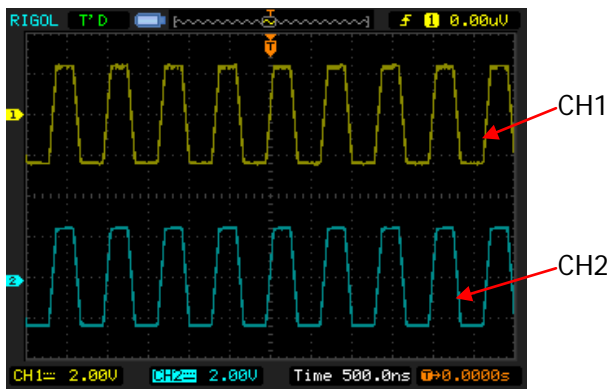

Figure 2-4 After Restore

Note that **Restore** is grayed out and disabled if any of the two channels is in modulation mode.

## To Enable Output

After configuring the parameters of the waveform selected, waveform output could be enabled.

Note: before enabling waveform output, you can also configure parameters (such as Resistance and Polarity) related to the channel output through “CH1/CH2Set” menu in **Utility**. For details, please refer to the introduction in **Channel Setting**.

Press **Output1** or/and **Output2** at the front panel and the backlight of the button turns on. The instrument outputs the configured waveform from the **[Output1]** or/and **[Output2]** connector at the front panel.

## Basic Waveform Output Example

Configure the generator to output a pulse waveform with 1.5MHz frequency, 500mVpp amplitude, 5mV<sub>DC</sub> DC offset, 200ns pulse width, 75ns leading (rising) edge time, 100ns trailing (falling) edge time and 5ns delay.

1. Press **CH1** at the front panel and the backlight turns on, indicating that CH1 is selected.
2. Press **Pulse** at the front panel and the backlight turns on, indicating that Pulse waveform is selected.
3. Press **Freq/Period** to highlight “Freq”. The lightspot above the number indicates current cursor location (as shown in the figure below). Use the numeric keyboard or direction keys and knob to input the frequency value “1.5” and select the unit “MHz” from the pop-up menu.

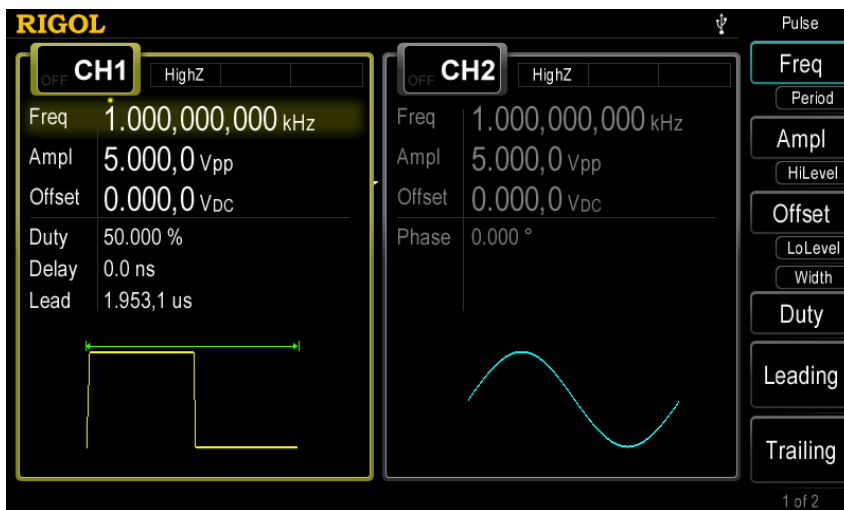

Figure 2-5 To Set Waveform Parameters

4. Press **Ampl/HiLevel** to highlight “Ampl”. The lightspot above the number indicates current cursor location. Use the numeric keyboard or direction keys and knob to input the amplitude value “500” and select the unit “mVpp” from the pop-up menu.

5. Press **Offset/LoLevel** to highlight "Offset". The lightspot above the number indicates current cursor location. Use the numeric keyboard or direction keys and knob to input the offset value "5" and select the unit "mV<sub>DC</sub>" from the pop-up menu.
6. Press **Width/Duty** to highlight "Width". The lightspot above the number indicates current cursor location. Use the numeric keyboard or direction keys and knob to input "200" and select the unit "nsec" from the pop-up menu. At this point, the pulse duty cycle changes accordingly.
7. Press **Leading** to highlight it. The lightspot above the number indicates current cursor location. Use the numeric keyboard or direction keys and knob to input "75" and select the unit "nsec" from the pop-up menu. Press **Trailing** to highlight it. The lightspot above the number indicates current cursor location. Use the numeric keyboard or direction keys and knob to input "100" and select the unit "nsec" from the pop-up menu.
8. Press **Delay** to highlight it. The lightspot above the number indicates current cursor location. Use the numeric keyboard or direction keys and knob to input "5" and select the unit "nsec" from the pop-up menu.
9. Press **Output1** at the front panel to turn CH1 output on. At this point, CH1 outputs waveform with the specified parameters. Connect the output terminal of CH1 to the oscilloscope and the waveform is as shown in the figure below.

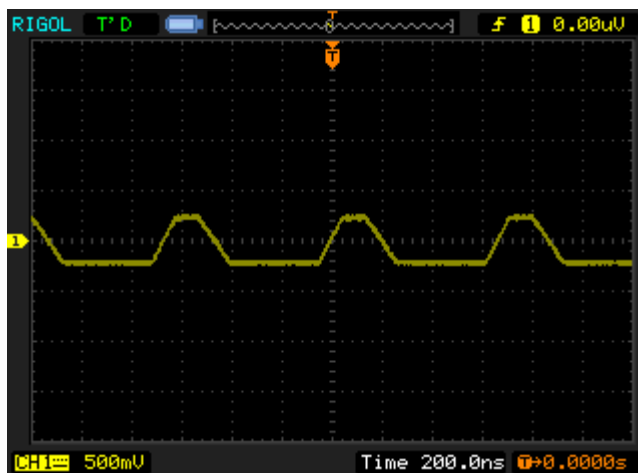

Figure 2-6 To Output Pulse Waveform



## Chapter 3 Arbitrary Waveform Output

DG4000 provides 150 kinds of built-in arbitrary waveforms stored in non-volatile memory and allows users to store 10 user-defined arbitrary waveforms in non-volatile memory and 1 user-defined arbitrary waveform in volatile memory. Users can also store the user-defined arbitrary waveform in external memory (such as USB storage device). User-defined waveforms can contain 1 (DC voltage) to 16384 (16k) data points, namely 1pts to 16kpts.

DG4000 can output the built-in and user-defined arbitrary waveforms from a single channel or from two channels at the same time. This chapter introduces how to configure the generator to output arbitrary waveforms.

Subjects in this chapter:

- To Enable Arbitrary Waveform
- Point By Point Output Mode
- To Select Arbitrary Waveform
- To Create New Arbitrary Waveform
- To Edit Arbitrary Waveform

## To Enable Arbitrary Waveform

Press **Arb** to enable arbitrary waveform function and open the operation menu of arbitrary waveform.

1. **Freq/Period:** set the output "Frequency/Period" of the arbitrary waveform.
2. **Ampl/HiLevel:** set the output "Amplitude/High Level" of the arbitrary waveform.
3. **Offset/LoLevel:** set the output "Offset/Low Level" of the arbitrary waveform.
4. **Phase:** set the "Start Phase" of the arbitrary waveform.
5. **Align Phase:** refer to **Align Phase**.
6. **Point By Point:** enable the point by point output mode of arbitrary waveform.
7. **Select Wform:** select arbitrary waveform stored in internal or external memory.
8. **Create New:** users can define waveform with up to 16 kpts.
9. **Edit Wform:** edit the stored arbitrary waveform.

Refer to **Basic Waveform Output** to configure the parameters and output. This chapter will focus on "Point By Point", "Select Waveform", "Create New" and "Edit Waveform".

### Tip

Users can also press **User** at the front panel to quickly set arbitrary waveform parameters including frequency/period, amplitude/high level, offset/low level, start phase and align phase. At this point, the waveform output is the waveform defined in **Utility** → **UserKey** (refer to introduction in **User-defined Waveform Key**).



## Point By Point Output Mode

DG4000 supports point by point output of arbitrary waveform. Press **Arb** to open the arbitrary waveform setting menu and press **Point By Point** to enable the point by point output mode of arbitrary waveform.

In point by point output mode, the generator calculates the frequency (30.517578125kHz) of the output signal automatically according to the wave table length (16,384) and sample rate. The generator outputs waveform points one by one at this fixed frequency. Point by point output mode can prevent the loss of important waveform points.

## To Select Arbitrary Waveform

DG4000 allows users to select arbitrary waveforms stored in internal or external memory for output. Press **Arb**, use  to open the 2/2 menu page, and then press **Select Wform** to select "BuiltIn", "Stored Wforms" or "Volatile Wform" for arbitrary waveform output.

### Built-In Waveform

Select from the 150 kinds of built-in arbitrary waveforms of DG4000 as shown in the table below. Press **BuiltIn** and select a kind ("Common", "Project", "SectMod", "Bioelect", "Medical", "Standard", "Maths", "Trigonom", "Anti Trigonom" or "Window"); the corresponding waveforms are displayed on the interface; use the knob to select the desired waveform; use  to open the 2/2 menu page and press **Select** to select the specified waveform.

Table 3-1 Built-in Waveform Table

Name	Explanation
<b>Common</b>	
DC	DC signal
AbsSine	Absolute value of a Sine
AbsSineHalf	Absolute value of half a Sine
AmpALT	Gain oscillation curve
AttALT	Attenuation oscillation curve
GaussPulse	Gauss pulse
NegRamp	Negative ramp
NPulse	Negative pulse
PPulse	Positive pulse
SineTra	Sine-Tra waveform
SineVer	Sine-Ver waveform
StairDn	Stair-down waveform
StairUD	Stair-up and stair-down waveform
StairUp	Stair-up waveform
Trapezia	Trapezoid waveform
<b>Project</b>	

BandLimited	Bandwidth-limited signal
BlaseiWave	Time-velocity curve of explosive vibration
Butterworth	Butterworth filter
Chebyshev1	Chebyshev1 filter
Chebyshev2	Chebyshev2 filter
Combin	Combination function
CPulse	C pulse
CWPulse	CW pulse
DampedOsc	Time-displacement curve of damped oscillation
DualTone	Dual-tone signal
Gamma	Gamma signal
GateVibar	Gate self-oscillation signal
LFMPulse	Linear FM pulse
MCNoise	Mechanical construction noise
Discharge	Discharge curve of Ni-MH battery
Pahcur	Current waveform of DC brushless motor
Quake	Analog quake waveform
Radar	Analog radar waveform
Ripple	Ripple wave of battery
RoundHalf	RoundHalf wave
RoundsPM	RoundsPM waveform
StepResp	Step-response signal
SwingOsc	Kinetic energy- time curve of swing oscillation
TV	TV signal
Voice	Voice signal
<b>Sec-Mod</b>	
AM	Sectioned sine AM signal
FM	Sectioned sine FM signal
PFM	Sectioned pulse FM signal
PM	Sectioned sine PM signal
PWM	Sectioned PWM signal
<b>Bioelect</b>	
Cardiac	Cardiac signal
EOG	Electro-Oculogram
EEG	Electroencephalogram
EMG	Electromyogram

Pulseilogram	Pulsilogram
ResSpeed	Speed curve of the respiration
<b>Medical</b>	
LFPulse	Waveform of the low frequency pulse electrotherapy
Tens1	Waveform 1 of the nerve stimulation electrotherapy
Tens2	Waveform 2 of the nerve stimulation electrotherapy
Tens3	Waveform 3 of the nerve stimulation electrotherapy
<b>Standard</b>	
Ignition	Ignition waveform of the automotive motor
ISO16750-2 SP	Automotive starting profile with ringing
ISO16750-2 VR	Automotive supply voltage profile for resetting
ISO7637-2 TP1	Automotive transients due to disconnects
ISO7637-2 TP2A	Automotive transients due to inductance in wiring
ISO7637-2 TP2B	Automotive transients due ignition switching off
ISO7637-2 TP3A	Automotive transients due to switching
ISO7637-2 TP3B	Automotive transients due to switching
ISO7637-2 TP4	Automotive supply profile during starting
ISO7637-2 TP5A	Automotive transients due to battery disconnect
ISO7637-2 TP5B	Automotive transients due to battery disconnect
SCR	SCR firing profile
Surge	Surge signal
<b>Math</b>	
Airy	Airy function
Besselj	Bessell function
Bessely	Besselll function
Cauchy	Cauchy distribution function
Cubic	Cubic function
Dirichlet	Dirichlet function
Erf	Error function
Erfc	Complementary error function
ErfcInv	Inverted complementary error function
ErfInv	Inverted error function
ExpFall	Exponential fall function
ExpRise	Exponential rise function
Gauss	Gauss distribution
HaverSine	HaverSine function

Laguerre	4-times Laguerre polynomial
Laplace	Laplace distribution
Legend	5-times Legend polynomial
Log	Logarithm function with the base 10
LogNormal	Logarithmic Gaussian distribution
Lorentz	Lorentz function
Maxwell	Maxwell distribution
Rayleigh	Rayleigh distribution
Versiera	Versiera
Weibull	Weibull distribution
ARB_X2	Square function
<b>Trigonome</b>	
CosH	Hyperbolic cosine
CosInt	Integral cosine
Cot	Cotangent
CotHCon	Concave hyperbolic cotangent
CotHPro	Protuberant hyperbolic cotangent
CscCon	Concave cosecant
CscPro	Protuberant cosecant
CscHCon	Concave hyperbolic cosecant
CscHPro	Protuberant hyperbolic cosecant
RecipCon	Concave reciprocal
RecipPro	Protuberant reciprocal
SecCon	Concave secant
SecPro	Protuberant secant
SecH	Hyperbolic secant
Sinc	Sinc function
SinH	Hyperbolic sine
SinInt	Integral sine
Sqrt	Square root
Tan	Tangent
TanH	Hyperbolic tangent
<b>Anti Trigonome</b>	
ACos	Arc cosine
ACosH	Arc hyperbolic cosine
ACotCon	Concave arc cotangent

ACotPro	Protuberant arc cotangen
ACotHCon	Concave arc hyperbolic cotangent
ACotHPro	Protuberant arc hyperbolic cotangent
ACscCon	Concave arc cosecant
ACscPro	Protuberant arc cosecant
ACscHCon	Concave arc hyperbolic cosecant
ACscHPro	Protuberant arc hyperbolic cosecant
ASecCon	Concave arc secant
ASecPro	Protuberant arc secant
ASecH	Arc hyperbolic secant
ASin	Arc Sinc
ASinH	Arc hyperbolic sine
ATan	Arc tangent
ATanH	Arc hyperbolic tangent
<b>Window</b>	
Bartlett	Bartlett window
BarthannWin	Modified Bartlett-Hann window
Blackman	Blackman window
BlackmanH	BlackmanH window
BohmanWin	Bohman window
Boxcar	Rectangle window
ChebWin	Chebyshev window
FlattopWin	Flat Top weighted window
Hamming	Hamming window
Hanning	Hanning window
Kaiser	Kaiser window
NuttallWin	Nuttall-defined minimum 4-term Blackman-Harris window
ParzenWin	Parzen window
TaylorWin	Taylor window
Triang	Triangle window (Fejer window)
TukeyWin	Tukey (tapered cosine) window

## Stored Waveform

Select arbitrary waveforms stored in internal non-volatile memory (C Disk) or external memory (D Disk). Press this softkey to enter the Store/Recall Interface and the **Store** key at the front panel is illuminated. Please select and read the desired arbitrary waveform file. For more details, please refer to **Store and Recall**. Waveform data in volatile memory will be changed after the file is read. To return to arbitrary waveform setting interface, press **Arb**.

## Volatile Waveform

Select arbitrary waveform currently stored in the volatile memory. Note that this menu would be unavailable if there is no waveform data in volatile memory currently. To fill up the volatile memory, you can create a waveform through “**Create New**” or select a waveform from “**Built-In**” or “**Stored Wforms**”.

When “Volatile Wforms” is selected, users can edit the volatile waveform using the **Edit Wfrom** menu. The new waveform data will overwrite the previous data in the volatile memory. You can also save the new volatile waveform in non-volatile memory.

Note: only when **Output1** or/and **Output2** is pressed and the backlight of the button turns on, can the instrument output the specified arbitrary waveform from the corresponding output terminal.

# To Create New Arbitrary Waveform

Press **Arb**, use  to open the 2/2 menu page, and then press **Create New** to open the arbitrary waveform creation interface.

## 1. Cycle Period

Press this softkey and use the numeric keyboard or direction keys and knob to set the cycle period of the new waveform. Cycle period is the boundary time of the waveform and the range is from 25.0ns to 1Ms.

Note that the time of the last point that can be defined should be lower than the cycle period.

## 2. High VLimit

Press this softkey and use the numeric keyboard or direction keys and knob to set the level upper limit of the new waveform. The level upper limit is the maximum voltage that can be set during waveform edit. The level upper limit must be greater than the "Low VLimit" currently set and lower than or equal to +5V (50Ω).

## 3. Low VLimit

Press this softkey and use the numeric keyboard or direction keys and knob to set the level lower limit of the new waveform. The level lower limit is the minimum voltage that can be set during waveform edit. The level lower limit must be greater than or equal to -5V (50Ω) and lower than the "High VLimit" currently set.

## 4. Init #Points

When creating a new waveform, the waveform editor will automatically create a waveform with two points. By default, point 1 is located at 0 seconds and point 2 at half of the specified cycle period. In addition, the levels of the two points are equal to the specified "**Low VLimit**". Press this softkey and use the numeric keyboard or direction keys and knob to set the initial points of the new waveform. DG4000 allows users to create arbitrary waveform with 1 to 16384 (16K) points. If in need, you can "**Insert Point**" or "**Delete Point**" later.



## 5. Interp

Press this softkey to enable or disable the interpolation between the defined waveform points.

- **Off:** The waveform editor will hold a constant voltage level between two points and create a step waveform.
- **Linear:** The waveform editor will automatically connect the two defined points with a straight line.

## 6. Edit Points

Define a waveform by specifying the time and voltage of each waveform point. Press this softkey to enter the "Edit Points" interface.

- **PointID:** Set the ID of the point to be edited. The default is 1. You can use the numeric keyboard or direction keys and knob to modify this parameter.
- **Time:** Set the time of the current point in a period. This setting is limited by the times of the previous and the next points. Note that the time of point 1 is fixed at 0 s.
- **Voltage:** Set the voltage of the current point in mV or V. The range of the voltage is limited by the "**High VLimit**" and "**Low VLimit**". Note that the waveform editor will automatically set the voltage of the last point to the voltage of point 1 to create a continuous waveform.
- **Insert Point:** Insert a waveform point at the middle position of the currently edited point and the next edited point.
- **Delete Point:** Delete the current point from the waveform and connect the remaining points using the current interpolation method. Note that point 1 cannot be deleted.

## 7. Edit Block

Define a waveform by editing the time and voltage of the start and end points and automatically setting the points between them through linear interpolation. Press **Interp** to select "Linear", and then press this softkey to enter the "Edit Block" interface. Note that if "Linear" is not selected in **Interp**, this menu is grayed out and disabled.

- **X1:** Set the ID of the start point of the block (namely the time position of the start point). Note that this value should be lower than the "Init Points" and be equal to or lower than X2.
- **Y1:** Set the voltage of the start point in mV or V. The setting range of

voltage is limited by "High VLimit" and "Low VLimit".

- **X2:** Set the ID of the end point of the block (namely the time position of the end point). Note that this value should be lower than or equal to the "Init Points" and be greater than or equal to X1.
- **Y2:** Set the voltage of the end point in mV or V. The setting range of voltage is limited by "High VLimit" and "Low VLimit".
- **Execute:** Edit the points between the start and end points according to the current setting.
- **Delete:** Delete the points that can be edited between X1 and X2 and connect the start and end points using the current interpolation method. Note that point 1 cannot be deleted.

## 8. Save

The currently created waveform is stored in the volatile memory by default. When creating a new waveform, the previous waveform in volatile memory will be overwritten. Users can store the waveform created in internal non-volatile memory (C Disk) or external memory (D Disk). Press **Save** to enter the file storage interface (refer to **Store and Recall**) to store the waveform created.

### Tips

Users can also use the PC software to edit arbitrary waveform and use the following methods to store the waveform in internal memory or external memory:

- ✧ Use SCPI command (For details, please refer to DG4000 Programming Guide).  
:TRACe:DAC VOLATILE,<binary\_block\_data>
- ✧ Save the waveform file stored in USB storage device (identified as "D Disk" in the instrument) to internal memory (C Disk) through the file management system.

## Example: Edit Points

The following example introduces how to use “Edit Points” to create an arbitrary waveform fulfilling the following conditions.

Parameter	Value
Cycle Period	12 $\mu$ s
High VLimit	4V
Low VLimit	-2V
Interp	Linear
Point 1	0s, 0V
Point 2	4 $\mu$ s, 4V
Point 3	8 $\mu$ s, 0V
Point 4	10 $\mu$ s, -2V

### Operation Procedures:

1. Press **Arb** and use  to open the 2/2 menu page; then press **Create New** → **Cycle Period**, use the numeric keyboard to input “12” and select the unit “ $\mu$ s” from the pop-up menu.
2. Press **High VLimit**, use the numeric keyboard to input “4” and select the unit “V” from the pop-up menu.
3. Press **Low VLimit**, use the numeric keyboard to input “-2” and select the unit “V” from the pop-up menu.
4. Press **Init #Points**, use the numeric keyboard to input “4” and press **OK**.  
Note: at this point, a -2 V level line appears.
5. Press **Interp** to select “Linear”.
6. Press **Edit Points** to enter the “Edit Points” interface.

- 1) Press **PointID** to define the first point (the time is 0 by default). Press **Voltage**, use the numeric keyboard to input "0" and select the unit "V" from the pop-up menu.
- 2) Press **PointID** again, use the numeric keyboard or knob to select point 2; then press **Time** and **Voltage** to input  $4\mu\text{s}$  and 4 V respectively.
- 3) Refer to step 2) to input point 3 and 4 in the table.
- 4) After finishing editing all the points, press **OK** to return to the previous menu. At this point, press **Save** to enter the file storage interface (refer to **Store and Recall**) to save the edited arbitrary waveform.

7. Observe the edited arbitrary waveform.

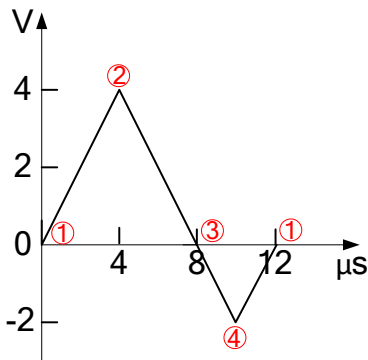

**Explanation:** as shown in the figure above, the waveform editor will automatically set the voltage of the last point to that of point 1 to create a continuous waveform.

## Example: Edit Block

The following example introduces how to use “Edit Block” to create an arbitrary waveform fulfilling the following conditions.

Parameter	Value
Cycle Period	12 $\mu$ s
High VLimit	4V
Low VLimit	-2V
Interp	Linear
X1Y1	2, 4V
X2Y2	4, -2V

### Operation Procedures:

1. Press **Arb** and use  to open the 2/2 menu page; then press **Create New** → **Cycle Period**, use the numeric keyboard to input “12” and select the unit “ $\mu$ s” from the pop-up menu.
2. Press **High VLimit**, use the numeric keyboard to input “4” and select the unit “V” from the pop-up menu.
3. Press **Low VLimit**, use the numeric keyboard to input “-2” and select the unit “V” from the pop-up menu.
4. Press **Init #Points**, use the numeric keyboard to input “4” and press **OK**.  
Note: at this point, a -2 V level line appears.
5. Press **Interp** to select “Linear”.
6. Press **Edit Block** to enter the “Edit Block” interface.
  - 1) Press **X1** and use the numeric keyboard to input “2”; then press **Y1**, use the numeric keyboard to input “4” and select the unit “V” from the pop-up menu. Use the same method to set X2 and Y2.

- 2) Press **Execute** to apply the setting of step 1). The waveform editor will connect point 1 (level is -2 V) to point 2 (level is 4 V), point 2 to point 4 as well as point 4 to point 1 using straight lines.
- 3) After finishing editing all the points, press  to return to the previous menu. At this point, press **Save** to enter the file storage interface (refer to **Store and Recall**) to save the edited arbitrary waveform.

7. Observe the edited arbitrary waveform.

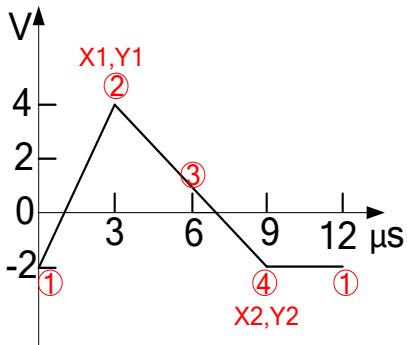

**Explanation:** as shown in the figure above, the waveform editor will automatically set the voltage of the last point to that of point 1 to create a continuous waveform.

## To Edit Arbitrary Waveform

Arbitrary waveforms stored in internal non-volatile memory or external memory can be edited.

Press **Arb** and use  to open the 2/2 menu page, then press **Edit Wform** to open waveform editing menu. Users can also press **Edit** at the front panel to quickly open this interface.

Only “Select Wform” which will be introduced in this section, is new in this menu compared to **Create New**. For other menu functions and operations, please refer to **To Create New Arbitrary Waveform**. Press **Edit Wform** → **Select Wform** to select the waveform to be edited.

### 1. To Edit Built-In waveforms

Select a waveform from the built-in waveforms to edit. You can store the edited waveform without overwriting the original built-in waveform.

### 2. To Edit Stored Waveforms

Select a waveform from internal non-volatile memory (C Disk) or external memory (D Disk) to edit. You can overwrite the old waveform or save the new waveform as a new file.





## Chapter 4 Harmonic Output

DG4000 can be used as a harmonic generator to output harmonic with specified order, amplitude and phase. It is usually used in the test of harmonic detector device or harmonic filter device. This chapter introduces how to configure the generator to output harmonics.

Subjects in this chapter:

- Overview
- To Set Fundamental Waveform Parameters
- To Set Harmonic Order
- To Select Harmonic Type
- To Set Harmonic Amplitude
- To Set Harmonic Phase

## Overview

According to Fourier transform, time domain waveform is the superposition of a series of sine waveforms as shown in the equation below:

$$f(t) = A_1 \sin(2\pi f_1 t + \varphi_1) + A_2 \sin(2\pi f_2 t + \varphi_2) + A_3 \sin(2\pi f_3 t + \varphi_3) + \dots$$

Generally, component with  $f_1$  frequency is called fundamental waveform,  $f_1$  is

fundamental waveform frequency,  $A_1$  is fundamental waveform amplitude and

$\varphi_1$  is fundamental waveform phase. The frequencies of other components (called harmonics) are all integral multiples of the fundamental waveform frequency. Components whose frequencies are odd multiples of the fundamental waveform frequency are odd harmonics and components whose frequencies are even multiples of the fundamental waveform frequency are even harmonics.

DG4000 can output up to 16th order of harmonic. After selecting CH1 or CH2, press **Harmonic** at the front panel to enter the harmonic setting menu. Users can set the parameters of fundamental waveform, set the type of harmonic, specify the highest order of harmonic and set the amplitude and phase of each order of harmonic.

After finishing harmonic parameter setting, press **Output1** or/and **Output2** and the backlight of the button turns on, the instrument outputs the specified harmonic from the corresponding output terminal.

## To Set Fundamental Waveform Parameters

DG4000 allows users to set various fundamental waveform parameters such as frequency, period, amplitude, DC offset voltage, high level, low level and start phase. It also supports align phase operation. Please refer to introductions in **Basic Waveform Output** to set fundamental waveform parameters.

## To Set Harmonic Order

The highest order of harmonic output from DG4000 can not be greater than this setting value.

After entering the harmonic setting menu, press **Order** (at this point, "Order" on the screen is highlighted) and use the numeric keyboard or the direction keys and knob to input the harmonic order. The range is limited by the maximum output frequency of the instrument as well as the fundamental waveform frequency.

- Range: integers within 2 to **maximum output frequency of the instrument ÷ fundamental waveform frequency**.
- The maximum is 16.

## To Select Harmonic Type

DG4000 can output even harmonic, odd harmonic, all orders of harmonic or user-defined orders of harmonic. After entering the harmonic setting menu, press **Type** to select the desired harmonic type.

### 1. Even

Press this key and the instrument would output fundamental waveform and even harmonics.

### 2. Odd

Press this key and the instrument would output fundamental waveform and odd harmonics.

### 3. All

Press this key and the instrument would output fundamental waveform and all the harmonics in order.

### 4. User

Press this key and the instrument would output the user-defined orders of harmonics. The highest order is 16.

16 bits binary data is used to represent the output status of the 16 orders of harmonics respectively, wherein, 1 represents enabling the output of the corresponding harmonic and 0 represents disabling the output of the corresponding harmonic. Users only need to use the numeric keyboard to modify the value of each data bit (note: the leftmost bit representing fundamental waveform is always X and can not be modified). For example, set the 16 bits data to X001 0000 0000 0001, thus 4th and 16th orders of harmonics are output.

Note: the actual harmonics output is determined by the "Order" currently specified.

## To Set Harmonic Amplitude

After entering the harmonic setting menu, press **Ampl** to set the amplitude of each order of harmonic.

1. **Sn**: press this softkey to select the sequence number of the harmonic to be set.
2. **Ampl**: press this softkey to set the amplitude of the harmonic selected. Use the numeric keyboard or direction keys and knob to input the amplitude value and then select the desired unit from the pop-up menu.
  - For the input method of amplitude value, refer to the introduction in **Parameter Setting Method**.
  - The amplitude units available are Vpp, mVpp, Vrms, mVrms and dBm (not available in HighZ).

## To Set Harmonic Phase

After entering the harmonic setting menu, press **Phase** to set the phase of each order of harmonic.

1. **Sn:** press this softkey to select the sequence number of the harmonic to be set.
2. **Phase:** press this softkey to set the phase of the harmonic selected. Use the numeric keyboard or the direction keys and knob to input the phase value and then select the unit “°” from the pop-up menu. For the input method of phase value, refer to the introduction in **Parameter Setting Method**.



## Chapter 5 Modulated Waveform Output

DG4000 supports AM, FM, PM, ASK, FSK, 3FSK, 4FSK, PSK, BPSK, QPSK, PWM and OSK modulations. DG4000 can output modulated waveform from a single channel or from two channels at the same time. The modulated waveform consists of carrier waveform and modulating waveform. The carrier waveform can be Sine, Square, Ramp, Arbitrary waveform (except DC) or Pulse (only in PWM). The modulating waveform can be from internal or external modulation source.

Subjects in this chapter:

- AM
- FM
- PM
- ASK
- FSK
- PSK
- BPSK
- QPSK
- 3FSK
- 4FSK
- OSK
- PWM

## AM

Modulated waveform usually consists of carrier waveform and modulating waveform. For amplitude modulation (AM), the amplitude of the carrier waveform varies with the instantaneous voltage of the modulating waveform.

### To Select AM Modulation

Press **Mod** → **Type** → **AM** to enable AM function.

- When **Mod** is enabled, **Sweep** or **Burst** will be disabled automatically (if enabled currently).
- After AM is enabled, the instrument will generate AM waveform with the currently specified carrier and modulating waveforms.

### To Select Carrier Waveform Shape

AM carrier waveform could be Sine, Square, Ramp or Arbitrary waveform (except DC). The default is Sine.

- Press the front panel key **Sine**, **Square**, **Ramp** or **Arb** → **Select Wform** (or **User**, the pre-defined waveform can not be DC) to select a desired carrier waveform shape.
- Pulse, Noise and DC could not be used as carrier waveform.

### To Set Carrier Frequency

Different carrier waveforms have different frequency ranges as shown in the table below. For all the carrier waveforms, the default value is 1kHz.

Carrier Waveform	Frequency Range
Sine	1 $\mu$ Hz to 160MHz
Square	1 $\mu$ Hz to 50MHz
Ramp	1 $\mu$ Hz to 4MHz
Arbitrary Waveform	1 $\mu$ Hz to 40MHz



After the carrier waveform is selected, you can press **Freq/Period** to highlight “Freq”, and then use the numeric keyboard or direction keys and knob to input the desired frequency value.

## To Select Modulating Waveform Source

DG4000 can accept modulating waveform from internal or external modulation source. Press **Mod** → **Source** to select “Int” or “Ext” modulation source.

### 1. Internal Source

When internal modulation source is selected, press **Shape** to select Sine, Square, Triangle, UpRamp, DnRamp, Noise or Arb as modulating waveform. The default is Sine.

- Square: 50% duty cycle.
- Triangle: 50% symmetry.
- UpRamp: 100% symmetry.
- DnRamp: 0% symmetry.
- Arb: when arbitrary waveform is selected as modulating waveform, the generator would limit the waveform length to 2kpts automatically.

Note: Noise can be used as modulating waveform but can not be used as carrier waveform.

### 2. External Source

When external modulation source is selected, the **Shape** menu will be grayed out and disabled. The generator accepts the external modulating signal from the **[Mod/FSK/Trig]** connector at the rear panel. The AM modulating amplitude is controlled by the  $\pm 2.5$  V signal level of the connector.



## To Set Modulating Waveform Frequency

When internal modulation source is selected, press **AM\_Freq** to set the modulating waveform frequency.

- Input the desired frequency value using the numeric keyboard or direction keys and knob.
- The modulating waveform frequency ranges from 2mHz to 50kHz, and the default value is 100Hz.

Notice that, this menu will be grayed out and disabled when external modulation source is selected.

## To Set Modulation Depth

Modulation depth expressed as a percentage indicates the amplitude variation degree. The AM modulation depth ranges from 0% to 120%. Press **AM Depth** to set AM modulation depth.

- In 0% modulation, the output amplitude is half of the specified value.
- In 100% modulation, the output amplitude is equal to the specified value.
- In >100% modulation, the output amplitude of the instrument would not exceed 10Vpp (50Ω load).

When "Ext" modulation source is selected, the output amplitude of the instrument is also controlled by the  $\pm 2.5\text{V}$  signal level at the **[Mod/FSK/Trig]** connector at the rear panel. For example, set the modulation depth to 100%, the output amplitude is the maximum when the modulating signal is +2.5V and the minimum when the modulating signal is -2.5V.

## FM

Modulated waveform consists of carrier waveform and modulating waveform. For frequency modulation (FM), the frequency of the carrier waveform varies with the instantaneous voltage of the modulating waveform.

### To Select FM Modulation

Press **Mod** → **Type** → **FM** to enable FM function.

- When **Mod** is enabled, **Sweep** or **Burst** will be disabled automatically (if currently enabled).
- After FM is enabled, the instrument will generate FM waveform with the currently specified carrier and modulating waveforms.

### To Select Carrier Waveform Shape

FM carrier waveform could be Sine, Square, Ramp or Arbitrary waveform (except DC). The default is Sine.

- Press the front panel key **Sine**, **Square**, **Ramp** or **Arb** → **Select Wform** (or **User**, the pre-defined waveform can not be DC) to select a desired carrier waveform shape.
- Pulse, Noise and DC could not be used as carrier waveform.

### To Set Carrier Frequency

Different carrier waveforms have different frequency ranges as shown in the table below. For all the carrier waveforms, the default value is 1kHz.

Carrier Waveform	Frequency Range
Sine	1μHz to 160MHz
Square	1μHz to 50MHz
Ramp	1μHz to 4MHz
Arbitrary Waveform	1μHz to 40MHz

After the carrier waveform is selected, you can press **Freq/Period** to highlight "Freq", and then use the numeric keyboard or direction keys and knob to input the desired frequency value.

## To Select Modulating Waveform Source

DG4000 can accept modulating waveform from internal or external modulation source. Press **Mod** → **Source** to select "Int" or "Ext" modulation source.

### 1. Internal Source

When internal modulation source is selected, press **Shape** to select Sine, Square, Triangle, UpRamp, DnRamp, Noise or Arb as modulating waveform. The default is Sine.

- Square: 50% duty cycle.
- Triangle: 50% symmetry.
- UpRamp: 100% symmetry.
- DnRamp: 0% symmetry.
- Arb: when arbitrary waveform is selected as modulating waveform, the generator would limit the waveform length to 2kpts automatically.

Note: Noise can be used as modulating waveform but can not be used as carrier waveform.

### 2. External Source

When external modulation source is selected, the **Shape** menu will be grayed out and disabled. The generator accepts the external modulating signal from the **[Mod/FSK/Trig]** connector at the rear panel. The frequency deviation is controlled by the  $\pm 2.5$  V signal level of the connector.



## To Set Modulating Waveform Frequency

When internal modulation source is selected, press **FM\_Freq** to set the modulating waveform frequency.

- Input the desired frequency value using the numeric keyboard or direction keys and knob.
- The modulating waveform frequency ranges from 2mHz to 50kHz, and the default value is 100Hz.

Notice that, this menu will be grayed out and disabled when external modulation source is selected.

## To Set Frequency Deviation

Frequency deviation is the deviation of the modulating waveform frequency relative to the carrier frequency. Press **Deviation** to set the FM frequency deviation.

- Frequency deviation must be lower than or equal to the carrier frequency.
- The sum of frequency deviation and carrier frequency must be lower than or equal to the sum of the current carrier frequency upper limit and 1kHz.

When "Ext" modulation source is selected, frequency deviation is controlled by the  $\pm 2.5V$  signal level at the **[Mod/FSK/Trig]** connector at the rear panel. Positive signal level corresponds to frequency increase and negative signal level corresponds to frequency decrease. The lower the level, the less offset is generated. For example, if the frequency deviation is set to 1kHz, +2.5V signal level corresponds to a 1kHz increase of frequency and -2.5V signal level corresponds to a 1kHz decrease of frequency.

## PM

Modulated waveform consists of carrier waveform and modulating waveform. For phase modulation (PM), the phase of the carrier waveform varies with the instantaneous voltage of the modulating waveform.

### To Select PM Modulation

Press **Mod** → **Type** → **PM** to enable PM function.

- When **Mod** is enabled, **Sweep** or **Burst** will be automatically disabled (if currently enabled).
- After PM is enabled, the instrument will generate PM waveform with the currently specified carrier and modulating waveforms.

### To Select Carrier Waveform Shape

PM carrier waveform could be Sine, Square, Ramp or Arbitrary waveform (except DC). The default is Sine.

- Press the front panel key **Sine**, **Square**, **Ramp** or **Arb** → **Select Wform** (or **User**, the pre-defined waveform can not be DC) to select the desired carrier waveform shape.
- Pulse, Noise and DC could not be used as carrier waveform.

### To Set Carrier Frequency

Different carrier waveforms have different frequency ranges as shown in the table below. For all the carrier waveforms, the default value is 1kHz.

Carrier Waveform	Frequency Range
Sine	1μHz to 160MHz
Square	1μHz to 50MHz
Ramp	1μHz to 4MHz
Arbitrary Waveform	1μHz to 40 MHz

After the carrier waveform is selected, you can press **Freq/Period** to highlight “Freq”, and then use the numeric keyboard or direction keys and knob to input the desired frequency value.

## To Select Modulating Waveform Source

DG4000 can accept modulating waveform from internal or external modulation source. Press **Mod** → **Source** to select “Int” or “Ext” modulation source.

### 1. Internal Source

When internal modulation source is selected, press **Shape** to select Sine, Square, Triangle, UpRamp, DnRamp, Noise or Arb as modulating waveform. The default is Sine.

- Square: 50% duty cycle.
- Triangle: 50% symmetry.
- UpRamp: 100% symmetry.
- DnRamp: 0% symmetry.
- Arb: when arbitrary waveform is selected as modulating waveform, the generator would limit the waveform length to 2kpts automatically.

Note: Noise can be used as modulating waveform but can not be used as carrier waveform.

### 2. External Source

When external modulation source is selected, the **Shape** menu will be grayed out and disabled. The generator accepts the external modulating signal from the **[Mod/FSK/Trig]** (as shown in the figure below) connector at the rear panel. The phase deviation is controlled by the  $\pm 2.5$  V signal level of the connector.



## To Set Modulating Waveform Frequency

When internal modulation source is selected, press **PM\_Freq** to set the modulating waveform frequency.

- Input the desired frequency value using the numeric keyboard or direction keys and knob.
- The modulating waveform frequency ranges from 2mHz to 50kHz, and the default value is 100Hz.

Notice that, this menu will be grayed out and disabled when external modulation source is selected.

## To Set Phase Deviation

Phase deviation is the deviation of the modulating waveform phase relative to the carrier waveform phase. Press **Deviation** to set the PM phase deviation.

- Use the numeric keyboard or direction keys and knob to input the desired phase value.
- The range of phase deviation is from 0° to 360°.

When "Ext" modulation source is selected, the phase deviation is controlled by the  $\pm 2.5V$  signal level at the **[Mod/FSK/Trig]** connector at the rear panel. For example, if the phase deviation is set to 180°, +2.5V signal level corresponds to a 180° phase variation. The lower the external signal level, the less deviation would be generated.



## ASK

When using ASK (Amplitude Shift Keying) modulation, you can configure the generator to “shift” its output amplitude between two preset amplitude values (“carrier amplitude” and “modulating amplitude”). The “shift” rate (ASK Rate) is determined by the internal signal level or signal level at the **[Mod/FSK/Trig]** connector at the rear panel.

### To Select ASK Modulation

Press **Mod** → **Type** → **ASK** to enable ASK function.

- When **Mod** is enabled, **Sweep** or **Burst** will be disabled automatically (if enabled currently).
- After ASK is enabled, the instrument will generate ASK waveform with the currently specified carrier and modulating waveforms.

### To Select Carrier Waveform Shape

ASK carrier waveform could be Sine, Square, Ramp or arbitrary waveform (except DC). The default is Sine.

- Press the front panel key **Sine**, **Square**, **Ramp** or **Arb** → **Select Wform** (or **User**, the pre-defined waveform can not be DC) to select the desired carrier waveform shape.
- Pulse, Noise and DC could not be used as carrier waveform.

### To Set Carrier Amplitude

After selecting carrier waveform shape, press **Ampl/HiLevel** to highlight “Ampl”, and then use the numeric keyboard or direction keys and knob to input the desired amplitude. The available amplitude range is limited by **Resistance** and **Freq/Period**. Please refer to the “Output Characteristics” described in **Specifications**.

## To Select Modulating Waveform Source

Press **Mod** → **Source** to select “Int” or “Ext” modulating waveform source.

### 1. Internal Source

When internal source is selected, the modulating waveform is set as a Square with 50% duty cycle, and the rate at which the output amplitude “shifts” between “carrier amplitude” and “modulating amplitude” is determined by “ASK Rate”.

### 2. External Source

When external source is selected, the generator accepts the external modulating signal from the **[Mod/FSK/Trig]** connector at the rear panel.



Note: the **[Mod/FSK/Trig]** connector is different when controlling ASK and AM/FM/PM modulations externally. In ASK modulation, the **[Mod/FSK/Trig]** connector has adjustable edge polarity.

## To Set ASK Rate

When internal source is selected, press **ASK Rate** to set the rate at which the output amplitude shifts between “carrier amplitude” and “modulating amplitude”.

- Use the numeric keyboard or direction keys and knob to input the desired frequency value.
- The frequency range is from 2mHz to 1MHz and the default is 100Hz.

Note: when “Ext” modulation source is selected, this menu would be grayed out and disabled.

## To Set Modulating Amplitude

Press **ModAmp** to set the modulating amplitude.

- Use the numeric keyboard or direction keys and knob to input the desired amplitude value.
- The range of amplitude (HighZ) is from 0 to 10V and the default is 2V.

## To Set Modulating Polarity

Press **Polarity** to select the "Pos" or "Neg" polarity of the modulating waveform to control the output amplitude.

In internal modulation, set the polarity to "Pos" and the generator would output the greater of the carrier amplitude and modulating amplitude when the modulating waveform is logic low and output the lower when the modulating waveform is logic high. The situation is the opposite when the polarity is set to "Neg".

In external modulation, set the polarity to "Pos" and the generator would output the greater of the carrier amplitude and modulating amplitude when logic low level is input and output the lower when the logic high level is input. The situation is the opposite when the polarity is set to "Neg".

## FSK

When FSK (Frequency Shift Keying) modulation is selected, you can configure the generator to “shift” its output frequency between two preset frequencies (“carrier frequency” and “hop frequency”). The “shift” frequency (FSK Rate) is determined by the internal signal level or signal level at the **[Mod/FSK/Trig]** connector at the rear panel.

### To Select FSK Modulation

Press **Mod** → **Type** → **FSK** to enable FSK function.

- When **Mod** is enabled, **Sweep** or **Burst** will be automatically disabled (if enabled currently).
- After FSK is enabled, the instrument will generate FSK waveform with the currently specified carrier and modulating waveforms.

### To Select Carrier Waveform Shape

FSK carrier waveform could be Sine, Square, Ramp or arbitrary waveform (except DC), and the default is Sine.

- Press the front panel key **Sine**, **Square**, **Ramp** or **Arb** → **Select Wform** (or **User**, the pre-defined waveform can not be DC) to select desired carrier waveform shape.
- Pulse, Noise and DC could not be used as carrier waveform.

### To Set Carrier Frequency

Different carrier waveforms have different frequency ranges as shown in the table below. For all the carrier waveforms, the default value is 1kHz.

Carrier Waveform	Frequency Range
Sine	1μHz to 160MHz
Square	1μHz to 50MHz
Ramp	1μHz to 4MHz
Arbitrary Waveform	1μHz to 40MHz

After the carrier waveform is selected, you can press **Freq/Period** to highlight “Freq”, and then use the numeric keyboard or direction keys and knob to input the desired frequency value.

## To Select Modulating Waveform Source

Press **Mod** → **Source** to select “Int” or “Ext” modulating waveform source.

### 1. Internal Source

When internal source is selected, the modulating waveform is set as a Square with 50% duty cycle, and the frequency at which the output frequency shifts between “carrier frequency” and “hop frequency” is determined by “FSK Rate”.

### 2. External Source

When external source is selected, the generator accepts the external modulating signal from the **[Mod/FSK/Trig]** connector at the rear panel.



Note: the **[Mod/FSK/Trig]** connector is different when controlling FSK and AM/FM/PM modulations externally. In FSK modulation, the **[Mod/FSK/Trig]** connector has adjustable edge polarity.

## To Set FSK Rate

When internal source is selected, press **FSK Rate** to set the frequency at which the output frequency shifts between “carrier frequency” and “hop frequency”.

- Use the numeric keyboard or direction keys and knob to input the desired frequency value.
- The frequency range is from 2mHz to 1MHz and the default is 100Hz.

Note: when “Ext” modulation source is selected, this menu is grayed out and disabled.

## To Set Hop Frequency

Alternating frequency (“hop” frequency) is the modulating frequency. The range of hop frequency depends on the carrier waveform currently selected. Press **HopFreq** to highlight it and input the desired frequency value using the numeric keyboard or direction keys and knob.

- Sine: 1 $\mu$ Hz to 160MHz
- Square: 1 $\mu$ Hz to 50MHz
- Ramp: 1 $\mu$ Hz to 4MHz
- Arb: 1 $\mu$ Hz to 40MHz

## To Set Modulating Polarity

Press **Polarity** to select the “Pos” or “Neg” polarity of the modulating waveform to control the output frequency.

In internal modulation, set the polarity to “Pos” and the generator would output the carrier frequency when the modulating waveform is logic low and output the hop frequency when the modulating waveform is logic high. The situation is the opposite when the polarity is set to “Neg”.

In external modulation, set the polarity to “Pos” and the generator would output the carrier frequency when logic low level is input and output the modulating frequency when logic high level is input. The situation is the opposite when the polarity is set to “Neg”.

## PSK

When PSK (Phase Shift Keying) modulation is selected, you can configure the generator to “shift” its output phase between two preset phase values (“carrier phase” and “modulating phase”). The “shift” frequency (PSK Rate) is determined by the internal signal level or signal level at the **[Mod/FSK/Trig]** connector at the rear panel.

### To Select PSK Modulation

Press **Mod** → **Type** → **PSK** to enable PSK function.

- When **Mod** is enabled, **Sweep** or **Burst** will be automatically disabled (if enabled currently).
- After PSK is enabled, the instrument will generate PSK waveform with the currently specified carrier and modulating waveforms.

### To Select Carrier Waveform Shape

PSK carrier waveform could be Sine, Square, Ramp or arbitrary waveform (except DC), and the default is Sine.

- Press the front panel key **Sine**, **Square**, **Ramp** or **Arb** → **Select Wform** (or **User**, the pre-defined waveform can not be DC) to select the desired carrier waveform shape.
- Pulse, Noise and DC could not be used as carrier waveform.

### To Set Carrier Phase

After carrier waveform shape is selected, press **Start Phase** to highlight it and use the numeric keyboard or direction keys and knob to input the desired phase. The available phase ranges from 0° to 360° and the default value is 0°.

## To Select Modulating Waveform Source

Press **Mod** → **Source** to select “Int” or “Ext” modulating waveform source.

### 1. Internal Source

When internal source is selected, the modulating waveform is set as a Square with 50% duty cycle, and the frequency at which the output phase shifts between “carrier phase” and “modulating phase” is determined by “PSK Rate”.

### 2. External Source

When external source is selected, the generator accepts the external modulating signal from the **[Mod/FSK/Trig]** connector (as shown in the figure below) at the rear panel.



Note: the **[Mod/FSK/Trig]** connector is different when controlling PSK and AM/FM/PM modulations externally. In PSK modulation, the **[Mod/FSK/Trig]** connector has adjustable edge polarity.

## To Set PSK Rate

When internal source is selected, press **PSK Rate** to set the frequency at which the output phase shifts between “carrier phase” and “modulating phase”.

- Use the numeric keyboard or direction keys and knob to input the desired frequency value.
- The frequency range is from 2mHz to 1MHz and the default is 100Hz.

Note: when “Ext” is selected, this menu is grayed out and disabled.



## To Set PSK Phase

PSK phase is the modulating phase. Press **Phase** to set the modulating phase.

- Use the numeric keyboard or direction keys and knob to input the desired phase value.
- The phase range is from 0° to 360° and the default is 180°.

## To Set Modulating Polarity

Press **Polarity** to select the “Pos” or “Neg” polarity of the modulating waveform to control the output phase.

In internal modulation, set the polarity to “Pos” and the generator would output the carrier phase when the modulating waveform is logic low and output the modulating phase when the modulating waveform is logic high. The situation is the opposite when the polarity is set to “Neg”.

In external modulation, set the polarity to “Pos” and the generator would output the carrier phase when logic low level is input and output the modulating phase when logic high level is input. The situation is the opposite when the polarity is set to “Neg”.

## BPSK

When BPSK (Binary Phase Shift Keying) is selected, you can configure the generator to “shift” its output phase between two preset phases (“carrier phase” and “modulating phase”). The “shift” frequency (BPSK rate) is determined by the internal signal level of the instrument.

### To Select BPSK Modulation

Press **Mod** → **Type** → **BPSK** to enable BPSK function.

- When **Mod** is enabled, **Sweep** or **Burst** will be automatically disabled (if enabled currently).
- After BPSK is enabled, the instrument will generate BPSK waveform with the currently specified carrier and modulating waveforms.

### To Select Carrier Waveform Shape

BPSK carrier waveform could be Sine, Square, Ramp or arbitrary waveform (except DC), and the default is Sine.

- Press the front panel key **Sine**, **Square**, **Ramp** or **Arb** → **Select Wform** (or **User**, the pre-defined waveform can not be DC) to select desired carrier waveform shape.
- Pulse, Noise and DC could not be used as carrier waveform.

### To Set Carrier Phase

After carrier waveform shape is selected, press **Start Phase** to highlight it and use the numeric keyboard or the direction keys and knob to input the desired phase. The phase range is from 0° to 360° and the default is 0°.

## To Select Modulating Waveform Source

BPSK uses internal modulation source. Press **Data Source** to select PN15, PN21, 01 or 10 and the default is PN15.

### Explanation:

PN sequence (Pseudo-noise Sequence), a kind of periodic binary sequence, has the statistical characteristics similar to a random noise but can be produced and processed repeatedly. The most commonly used PN sequence is m sequence generated by shift registers with linear feedback and its period is relevant to the linear feedback logic and the initial state of each register. The period of the m sequence generated by n-level shift register is  $2^n - 1$ . As In the figure below is a 4-level linear feedback shift register of which the feedback logic is  $a_3 \oplus a_2$ . For PN15 and PN21, 15 and 21 are levels of the registers.

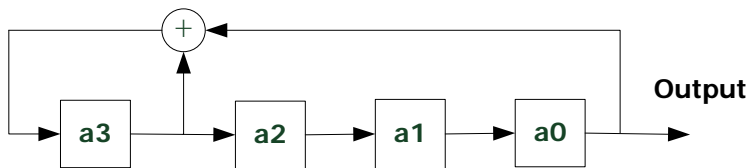

## To Set BPSK Rate

BPSK uses internal modulation source. Press **Rate** to set the frequency at which the output phase shifts between “carrier phase” and “modulating phase”.

- Use the numeric keyboard or direction keys and knob to input the desired frequency value.
- The frequency range is from 2mHz to 1MHz and the default is 100Hz.

## To Set BPSK Phase

BPSK phase is the modulating phase. Press **Phase** to set the modulating phase.

- Use the numeric keyboard or direction keys and knob to input the desired phase value.
- The phase range is from 0° to 360° and the default is 180°.

## QPSK

When QPSK (Quadrature Phase Shift Keying) is selected, you can configure the generator to “shift” its output phase among four preset phases (“carrier phase” and three “modulating phases”). The “shift” frequency (QPSK rate) is determined by the internal signal level of the instrument.

### To Select QPSK Modulation

Press **Mod** → **Type** → **QPSK** to enable QPSK function.

- When **Mod** is enabled, **Sweep** or **Burst** will be automatically disabled (if enabled currently).
- After QPSK is enabled, the instrument will generate QPSK waveform with the currently specified carrier and modulating waveforms.

### To Select Carrier Waveform Shape

QPSK carrier waveform could be Sine, Square, Ramp or arbitrary waveform (except DC), and the default is Sine.

- Press the front panel key **Sine**, **Square**, **Ramp** or **Arb** → **Select Wform** (or **User**, the pre-defined waveform can not be DC) to select desired carrier waveform shape.
- Pulse (basic waveform), Noise and DC could not be used as carrier waveform.

### To Set Carrier Phase

After carrier waveform shape is selected, press **Start Phase** to highlight it and use the numeric keyboard or direction keys and knob to input the desired phase. The phase range is from 0° to 360° and the default is 0°.

## To Select Modulating Waveform Source

QPSK uses internal modulation source. Press **Data Source** to select PN15 or PN21 and the default is PN15.

## To Set QPSK Rate

QPSK uses internal modulation source. Press **Rate** to set the frequency at which the output phase shifts between “carrier phase” and “modulating phase”.

- Use the numeric keyboard or direction keys and knob to input the desired frequency value.
- The frequency range is from 2mHz to 1MHz and the default is 100Hz.

## To Set QPSK Phases

QPSK phases are the modulating phases. Press **Phase1**, **Phase2** and **Phase3** to set the modulating phases respectively.

- Use the numeric keyboard or direction keys and knob to input the desired phase value.
- The phase range is from 0° to 360° and the default values of **Phase1**, **Phase2** and **Phase3** are 450°, 135° and 225° respectively.

## 3FSK

When 3FSK (3 Frequency Shift Keying) modulation is selected, you can configure the generator to “shift” its output frequency among three preset frequencies (“carrier frequency” and two “modulating frequencies”). The “shift” frequency (3FSK rate) is determined by the internal signal level of the instrument.

### To Select 3FSK Modulation

Press **Mod** → **Type** → **3FSK** to enable 3FSK function.

- When **Mod** is enabled, **Sweep** or **Burst** will be automatically disabled (if enabled currently).
- After 3FSK is enabled, the instrument will generate 3FSK waveform with the currently specified carrier and modulating waveforms.

### To Select Carrier Waveform Shape

3FSK carrier waveform could be Sine, Square, Ramp or arbitrary waveform (except DC), and the default is Sine.

- Press the front panel key **Sine**, **Square**, **Ramp** or **Arb** → **Select Wform** (or **User**, the pre-defined waveform can not be DC) to select desired carrier waveform shape.
- Pulse (basic waveform), Noise and DC could not be used as carrier waveform.

### To Set Carrier Frequency

Different carrier waveforms have different frequency ranges as shown in the table below. For all the carrier waveforms, the default value is 1kHz.

Carrier Waveform	Frequency Range
Sine	1 $\mu$ Hz to 160MHz
Square	1 $\mu$ Hz to 50MHz
Ramp	1 $\mu$ Hz to 4MHz
Arbitrary Waveform	1 $\mu$ Hz to 40MHz

After the carrier waveform is selected, you can press **Freq/Period** to highlight "Freq", and then use the numeric keyboard or direction keys and knob to input the desired frequency value.

## Modulation Source

3FSK uses internal modulation source and the modulating waveform is Sine.

## To Set 3FSK Rate

3FSK uses internal modulation source. Press **KeyFreq** to set the frequency at which the output frequency shifts between "carrier frequency" and the two "hop frequencies".

- Use the numeric keyboard or direction keys and knob to input the desired frequency value.
- The frequency range is from 2mHz to 1MHz and the default is 100Hz.

## To Set Hop Frequencies

Alternating frequencies ("hop" frequencies) are the modulating frequencies. The ranges of hop frequencies depend on the carrier waveform currently selected. Press **HopFreq1** and **HopFreq2** to highlight them and input the desire frequency values using the numeric keyboard or direction keys and knob respectively.

- Sine: 1 $\mu$ Hz to 160MHz
- Square: 1 $\mu$ Hz to 50MHz
- Ramp: 1 $\mu$ Hz to 4MHz
- Arb: 1 $\mu$ Hz to 40MHz



## 4FSK

When 4FSK (4 Frequency Shift Keying) modulation is selected, you can configure the generator to “shift” its output frequency among four preset frequencies (“carrier frequency” and three “hop frequencies”). The “shift” frequency (4FSK rate) is determined by the internal signal level of the instrument.

### To Select 4FSK Modulation

Press **Mod** → **Type** → **4FSK** to enable 4FSK function.

- When **Mod** is enabled, **Sweep** or **Burst** will be automatically disabled (if enabled currently).
- After 4FSK is enabled, the instrument will generate 4FSK waveform with the currently specified carrier and modulating waveforms.

### To Select Carrier Waveform Shape

4FSK carrier waveform could be Sine, Square, Ramp or arbitrary waveform (except DC), and the default is Sine.

- Press the front panel key **Sine**, **Square**, **Ramp** or **Arb** → **Select Wform** (or **User**, the pre-defined waveform can not be DC) to select the desired carrier waveform shape.
- Pulse (basic waveform), Noise and DC could not be used as carrier waveform.

### To Set Carrier Frequency

Different carrier waveforms have different frequency ranges as shown in the table below. For all the carrier waveforms, the default value is 1kHz.

Carrier Waveform	Frequency Range
Sine	1 $\mu$ Hz to 160MHz
Square	1 $\mu$ Hz to 50MHz
Ramp	1 $\mu$ Hz to 4MHz
Arbitrary Waveform	1 $\mu$ Hz to 40MHz

After the carrier waveform is selected, you can press **Freq/Period** to highlight "Freq", and then use the numeric keyboard or direction keys and knob to input the desired frequency value.

## Modulation Source

4FSK uses internal modulation source and the modulating waveform is Sine.

## To Set 4FSK Rate

4FSK uses internal modulation source. Press **KeyFreq** to set the frequency at which the output frequency shifts between "carrier frequency" and three "hop frequencies".

- Use the numeric keyboard or direction keys and knob to input the desired frequency value.
- The frequency range is from 2mHz to 1MHz and the default is 100Hz.

## To Set Hop Frequencies

Alternating frequencies ("hop" frequencies) are the modulating frequencies. The ranges of hop frequencies depend on the carrier waveform currently selected. Press **HopFreq1**, **HopFreq2** and **HopFreq3** to highlight them and input the desired frequency values using the numeric keyboard or direction keys and knob respectively.

- Sine: 1 $\mu$ Hz to 160MHz
- Square: 1 $\mu$ Hz to 50MHz
- Ramp: 1 $\mu$ Hz to 4MHz
- Arb: 1 $\mu$ Hz to 40MHz

## OSK

When OSK (Oscillation Shift Keying) modulation is selected, users can configure the generator to output a sine signal with intermittent oscillation as shown in the figure below (the carrier waveform is 100Hz and the OSK rate is 10kHz). The start-oscillation and stop-oscillation of the internal crystal oscillator are controlled by the internal signal level or signal level at the **[Mod/FSK/Trig]** connector at the rear panel. When the internal crystal oscillator starts to oscillate, the instrument starts to output the carrier waveform and when the internal crystal stops oscillating, the output stops.

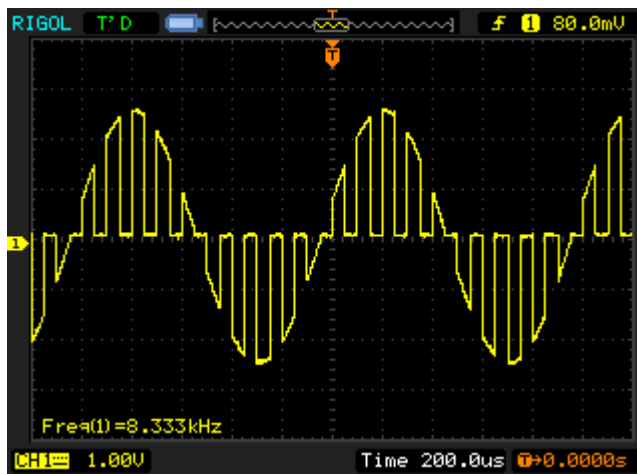

Figure 5-1 OSK Modulated Waveform

### To Select OSK Modulation

Press **Mod** → **Type** → **OSK** to enable OSK function.

- When **Sine** is currently selected, OSK in the **Type** is not available.
- When **Mod** is enabled, **Sweep** or **Burst** will be automatically disabled (if enabled currently).
- After OSK is enabled, the instrument will generate OSK waveform with the currently specified carrier and modulating waveforms.

## To Select Carrier Waveform Shape

OSK carrier waveform can only be sine waveform. Press **Sine** at the front panel.

## To Set Carrier Frequency

After carrier waveform shape is selected, press **Freq/Period** to highlight “Freq” and use the numeric keyboard or direction keys and knob to input the desired frequency. The range is from 1μHz to 160MHz.

## To Select Modulating Waveform Source

Press **Mod** → **Source** to select “Int” or “Ext” modulation source.

### 1. Internal Source

When internal source is selected, the modulating waveform is set as a Square with 50% duty cycle. At this point, the intermittence time and oscillate time of the output signal is determined by the OSK “Rate”.

### 2. External Source

When external source is selected, the generator accepts external modulating signal from the **[Mod/FSK/Trig]** connector at the rear panel.



## To Set OSK Rate

When internal source is selected, press **Rate** to set the OSK rate.

- Use the numeric keyboard or direction keys and knob to input the desired frequency value.
- The frequency range is from 2mHz to 1MHz and the default is 1kHz.

## To Set Oscillate Period

Oscillate period is the oscillation period of internal crystal oscillator. Press **OscTime** to highlight it and use the numeric keyboard or direction keys and knob to input the desired period. The range is from 8ns to 499.750 $\mu$ s.

## PWM

A PWM (Pulse Width Modulation) modulated waveform consists of carrier waveform and modulating waveform. The pulse width of the carrier waveform varies with the instantaneous voltage of the modulating waveform.

### To Select PWM Modulation

PWM can only be used to modulate pulse. To select PWM modulation, press **Pulse** at the front panel first and then press **Mod** to enable PWM function.

- If the **Pulse** function key has not been selected, PWM in **Type** menu is unavailable.
- When **Mod** is enabled but the modulation type is not PWM, pressing **Pulse** will select PWM automatically.
- When **Mod** is enabled, **Sweep** or **Burst** will be automatically disabled (if enabled currently).
- After PWM is enabled, the instrument will generate PWM waveform with the currently specified carrier and modulating waveforms.

### To Select Carrier Waveform Shape

As mentioned before, PWM can only be used to modulate Pulse. To select Pulse waveform, press **Pulse** at the front panel.

### To Set Pulse Width/Duty Cycle

After the carrier waveform shape is selected, press **Width/Duty** to highlight "Width" or "Duty" and input the desired value using the numeric keyboard or direction keys and knob.

## To Select Modulating Waveform Source

Press **Mod** → **Source** to select “Int” or “Ext” modulating waveform source.

### 1. Internal Source

When internal modulation source is selected, press **Shape** to select Sine, Square, Triangle, UpRamp, DnRamp, Noise or Arb as modulating waveform. The default is Sine.

- Square: 50% duty cycle.
- Triangle: 50% symmetry.
- UpRamp: 100% symmetry.
- DnRamp: 0% symmetry.
- Arb: when arbitrary waveform is selected as modulating waveform, the generator would limit the waveform length to 2kpts automatically.

Note: Noise can be used as modulating waveform but can not be used as carrier waveform.

### 2. External Source

When external modulation source is selected, the **Shape** menu will be grayed out and disabled. The generator accepts the external modulating signal from the **[Mod/FSK/Trig]** connector at the rear panel. The “WidthDev” (or “DutyDev”) is controlled by the  $\pm 2.5$  V signal level of the connector.

## To Set Modulating Waveform Frequency

When internal modulation source is selected, press **PWM Freq** to set the frequency of the modulating waveform.

- Use the numeric keyboard or direction keys and knob to input the desired frequency value.
- The frequency range is from 2mHz to 1MHz and the default is 100Hz.

Note: when “Ext” modulation source is selected, this menu is grayed out and disabled.

## To Set Pulse Width/Duty Cycle Deviation

Press **WidthDev** (or **DutyDev**) and input the desired value using the numeric keyboard or direction keys and knob.

- Width deviation represents the variation (in seconds) of the modulated waveform pulse width relative to the original pulse width.  
Pulse width deviation range: 0s to 500ks.  
The width deviation can not exceed the current pulse width.  
The width deviation is limited by the minimum pulse width and current edge time setting.
- Duty cycle deviation represents the variation (in %) of the modulated waveform duty cycle relative to the original pulse duty cycle.  
Duty cycle deviation range: 0% to 50%.  
The duty cycle deviation can not exceed the current pulse duty cycle.  
The duty cycle is limited by the minimum duty cycle and current edge time setting.

When "Ext" modulation source is selected, width deviation (or duty deviation) is controlled by the  $\pm 2.5V$  signal level at the **[Mod/FSK/Trig]** connector at the rear panel. For example, if the width deviation is set to 10s, the +2.5V signal level corresponds to a 10s variation in pulse width.



## Chapter 6 Sweep

DG4000 can output sweep from a single channel or from dual channels at the same time. In sweep mode, the generator varies its output from the start frequency to end frequency within the specified sweep time. DG4000 supports linear, log and step sweep modes, allows users to set start hold, end hold and return time, supports internal, external or manual trigger source and can generate sweep output for Sine, Square, Ramp and arbitrary waveform (except DC).

Subjects in this chapter:

- To Enable Frequency Sweep
- Start Frequency and End Frequency
- Center Frequency and Frequency Span
- Sweep Type
- Sweep Time
- Return Time
- Mark Frequency
- Start Hold
- End Hold
- Sweep Trigger Source
- Trigger Output Edge

## To Enable Frequency Sweep

Press **Sweep** at the front panel to enable the sweep function (the backlight of the key goes on), and **Mod** or **Burst** function will be automatically disabled (if currently enabled). The instrument will generate the sweep waveform from the corresponding channel (if currently turned on) according to the current configuration. You can also reset the sweep function menu. Please refer to the introduction in the following text for details.

## Start Frequency and End Frequency

Start frequency and end frequency are the upper and lower limits of the frequency for frequency sweep. The generator sweeps from the start frequency to the end frequency and then returns back to the start frequency.

- Start Frequency < End Frequency: the generator sweeps from low frequency to high frequency.
- Start Frequency > End Frequency: the generator sweeps from high frequency to low frequency.
- Start Frequency = End Frequency: the generator outputs with a fixed frequency.

When frequency sweep is enabled, press **Start/Center** to highlight “**Start**”. Notice that, “**End**” in **End/Span** will also be highlighted. Use the numeric keyboard or direction keys and knob to input the desired frequencies. By default, the start frequency is 100Hz and the end frequency is 1kHz. Different sweep waveform corresponds to different start frequency and end frequency range.

- Sine: 1μHz to 160MHz
- Square: 1μHz to 50MHz
- Ramp: 1μHz to 4MHz
- Arb: 1μHz to 40MHz

The generator will renewedly sweep from the specified “start frequency” after start frequency or end frequency is changed.

## Center Frequency and Frequency Span

You can also set the frequency boundaries of frequency sweep through center frequency and frequency span.

- Center Frequency = (|Start Frequency + End Frequency|) / 2
- Frequency Span = End Frequency – Start Frequency

When frequency sweep is enabled, press **Start/Center** to highlight “Center”. Notice that, “Span” in **End/Span** will also be highlighted. Use the numeric keyboard or direction keys and knob to enter the desired frequency values. By default, the center frequency is 550Hz and the frequency span is 900Hz.

Different sweep waveform corresponds to different center frequency and frequency span range and center frequency and frequency span are interrelative.

Define the minimum frequency of the waveform currently selected as  $F_{\min}$ , the

maximum frequency as  $F_{\max}$  and  $F_m = (F_{\min} + F_{\max}) / 2$ .

- The range of center frequency is from  $F_{\min}$  to  $F_{\max}$  and the parameters for

different waveforms are as follows:

Sine: 1 $\mu$ Hz to 160MHz

Square: 1 $\mu$ Hz to 50MHz

Ramp: 1 $\mu$ Hz to 4MHz

Arb: 1 $\mu$ Hz to 40MHz

- Frequency span range is influenced by the center frequency:

Center frequency  $< F_m$ : frequency span range is  $\pm 2 \times$  (center frequency

$- F_{\min}$ );

Center frequency  $\geq F_m$ : frequency span range is  $\pm 2 \times (F_{\max} -$  center

frequency).

Take sine as an example.  $F_{\min}$  is 1 $\mu$ Hz,  $F_{\max}$  is 160MHz and  $F_m$  is about

80MHz.

If the center frequency is 550Hz, the frequency span range is  $\pm 2 \times (550\text{Hz} - 1\mu\text{Hz}) = \pm 1.099999998\text{kHz}$ ; if the center frequency is 155MHz, the frequency span range is  $\pm 2 \times (160\text{MHz} - 155\text{MHz}) = \pm 10\text{MHz}$ .

The generator will renewedly sweep from the specified "Start Frequency" after "Center Frequency" or "Frequency Span" is changed.

**Tip**

In large-scale sweep, the amplitude characteristic of the output signal might change.

## Sweep Type

DG4000 provides three sweep types, including **Linear**, **Log** and **Step**, and the default is **Linear**.

### Linear Sweep

The output frequency of the instrument varies linearly in the way of "several Hertz per second". The variation is controlled by "Start Frequency", "End Frequency" and "Sweep Time".

When **Sweep** is enabled, press **SwpType** to select "Linear". A line is displayed on the waveform on the screen, indicating that the output frequency changes in linear mode.

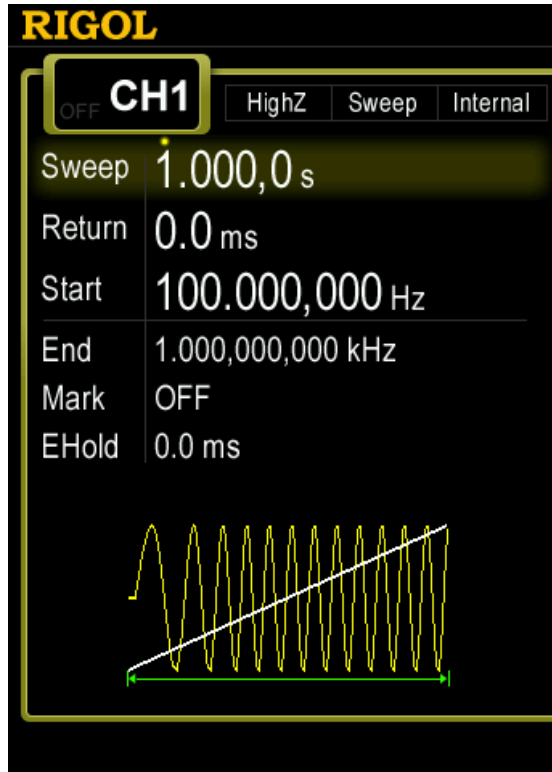

Figure 6-1 Linear Sweep

## Log Sweep

The output frequency of the instrument varies in a logarithmic fashion, that is, the output frequency changes in the way of “octave per second” or “decade per second”. The change is controlled by “Start Frequency”, “End Frequency” and “Sweep Time”.

When Log Sweep is enabled, users could set the following parameters:

Start Frequency ( $F_{start}$ ), End Frequency ( $F_{stop}$ ) and Sweep Time ( $T_{sweep}$ )

The function prototype of Log Sweep is  $F_{current} = P^T$ . P and T could be expressed by the above-mentioned parameters:

$$P = 10^{\lg(F_{stop}/F_{start})/T_{sweep}}$$

$$T = t + \lg(F_{start}) / \lg(P)$$

Wherein,  $t$  is the time from the start of the sweep and its range is from 0 to  $T_{sweep}$ .

$F_{current}$  is the instantaneous frequency of the current output.

When **Sweep** is enabled, press **SwpType** to select "Log". An exponential function curve is displayed on the waveform on the screen, indicating that the output frequency changes in a logarithmic mode.

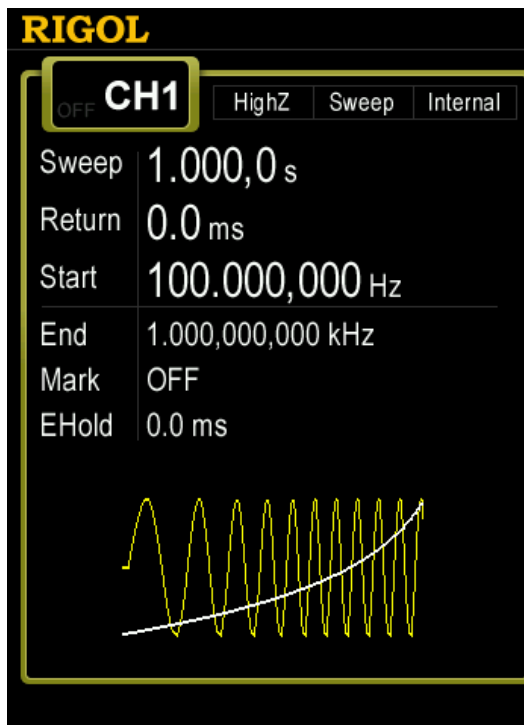



Figure 6-2 Log Sweep

## Step Sweep

The output frequency of the instrument "steps" from "Start Frequency" to "End Frequency". The duration of the output signal on each frequency point is

determined by “Sweep Time” and “Step Number”.

When **Sweep** is enabled, press **SwpType** to select “Step”. A step waveform is displayed on the waveform on the screen, indicating that the output frequency changes in “steps”. At this point, press  to open the 2/2 menu page. Press **StepNum** and use the numeric keyboard or knob to input the step number. The default is 2 and the range is from 2 to 2048. Note: in “Linear” and “Log” sweep modes, **StepNum** is grayed out and disabled.

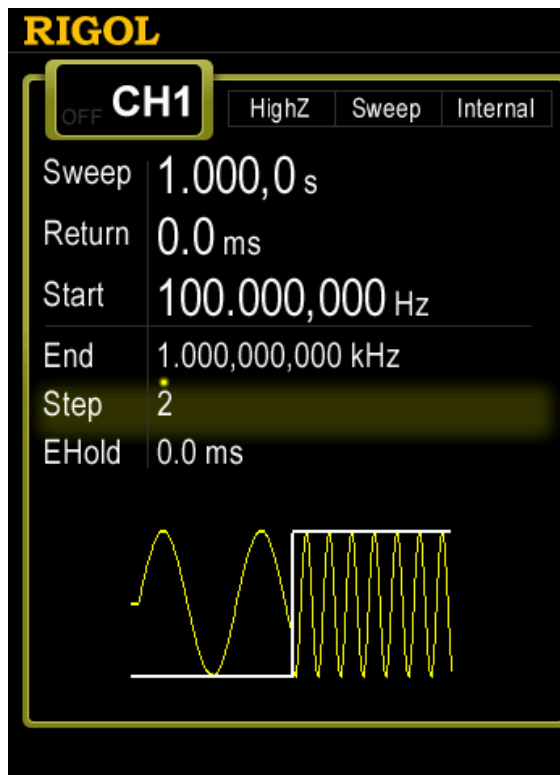

Figure 6-3 Step Sweep

## Sweep Time

When **Sweep** is enabled, press **SwpTime** and use the numeric keyboard or knob to change the sweep time. The default value is 1s and the available range is from 1ms to 300s. The generator will renewedly sweep and output from the specified “Start Frequency” once the sweep time is changed.

## Return Time

The generator will always sweep from “Start Frequency” to “End Frequency” and stay within “End Hold” time. Return time describes the time needed for the output to return to “Start frequency” from “End frequency” after “End hold”.

When **Sweep** is enabled, press **ReturnTime** and use the numeric keyboard or knob to change the return time. The default value is 0s and the available range is from 0s to 300s.

The generator will renewedly sweep from the specified “Start Frequency” once the return time is changed.

## Mark Frequency

The sync signal on the **[Sync]** connector corresponding to the channel at the front panel always changes from low-level to high-level at the start of each sweep, and changes from high-level to low-level at the middle of the sweep period when “Mark” function is disabled or at the specified mark frequency point when “Mark” function is enabled.

When **Sweep** is enabled, press **MarkFreq** and select “On”, as shown in the figure below, use the numeric keyboard or knob to modify the mark frequency. The default value is 550Hz and the available range is limited by “Start Frequency” and “End Frequency”.

The generator will renewedly sweep and output from the specified “Start Frequency” once the Mark Frequency is changed.

Note: in step sweep mode, **MarkFreq** is grayed out and disabled.



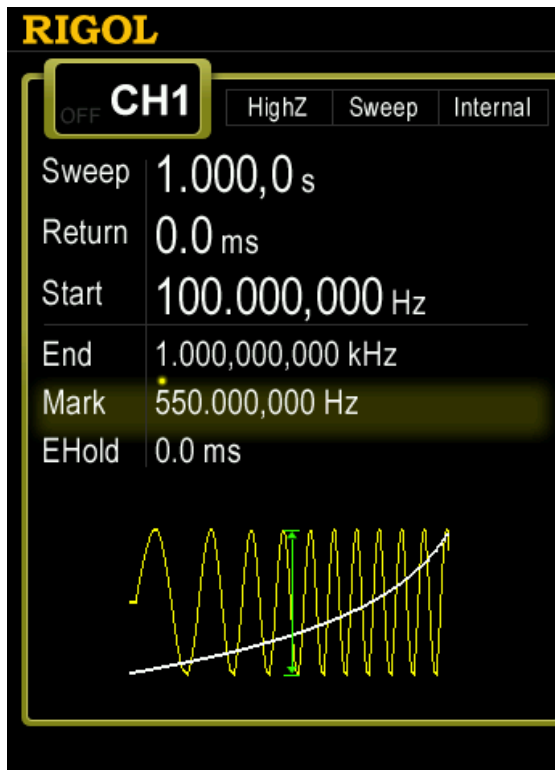



Figure 6-4 Mark Frequency

## Start Hold

Start Hold is the duration that the output signal outputs with the “Start Frequency” after the sweep starts. After the Start Hold, the generator will output with varying frequency in the current sweep type.

When **Sweep** is enabled, use  to open the 2/2 menu page, then press **Start Hold** and use the numeric keyboard or knob to change the Start Hold. The default value is 0s and the available range is from 0s to 300s.

The generator will renewedly sweep and output from the specified “Start Frequency” once the Start Hold is changed.

## End Hold

End Hold is the duration that the output signal outputs with the “End Frequency” after the generator has swept from the “Start Frequency” to the “End Frequency”.

When **Sweep** is enabled, use  to open the 2/2 menu page, then press **End Hold** and use the numeric keyboard or knob to change the End Hold. The default value is 0s and the available range is from 0s to 300s.

The generator will renewedly sweep and output from the specified “start frequency” once the End Hold is changed.

## Sweep Trigger Source

The sweep trigger source could be internal, external or manual. The generator will generate a sweep output when a trigger signal is received and then wait for the next trigger.

When **Sweep** is enabled, use  to open the 2/2 menu page and press **Source** to select “Int”, “Ext” or “Manual”. The default is “Int”.

### 1. Internal Trigger

The generator outputs continuous sweep waveform. The trigger period is determined by the specified sweep time, return time, start hold and end hold times.

### 2. External Trigger

The generator accepts the trigger signal input from the **[Mod/FSK/Trig]** connector at the rear panel. A sweep will be generated once the connector gets a TTL pulse with specified polarity. To set the TTL pulse polarity, press **SlopeIn** to select “Leading” or “Trailing”. The default is “Leading”.

Note that in “Int” and “Manual” trigger modes, the corresponding menu is **TrigOut**. The **[Mod/FSK/Trig]** connector at the rear panel is used as the output terminal of trigger signal.



### 3. Manual Trigger

A sweep will be generated from the corresponding channel once you press **Trigger1** or **Trigger2** at the front panel.

## Trigger Output Edge

In Sweep mode, when “Int” or “Manual” trigger source is selected, the generator will output a TTL compatible signal with specified edge from the **[Mod/FSK/Trig]** connector at the rear panel.



- Internal Trigger: the generator outputs a Square waveform with 50% duty cycle from the **[Mod/FSK/Trig]** connector at the beginning of the Sweep. The trigger period depends on the specified sweep time, return time, start hold and end hold.
- Manual Trigger: the generator outputs a Pulse waveform with greater than 1 $\mu$ s pulse width at the beginning of the Sweep from the **[Mod/FSK/Trig]** connector.
- External Trigger: the **[Mod/FSK/Trig]** connector is used as the input terminal of external trigger signal and has no trigger output.

When "Int" or "Manual" trigger is selected, press **TrigOut** to set the edge type of the trigger output signal. The default is "Off".

- Off: disable the trigger output signal.
- Leading: output the trigger signal at the rising edge.
- Trailing: output the trigger signal at the falling edge.

## Chapter 7 Burst

DG4000 can output waveform with specified number of cycles (called Burst) from a single channel or from dual channels at the same time. DG4000 supports control of burst output by internal, manual or external trigger source; supports three kinds of burst types including N cycle, infinite and gated. The generator can use Sine, Square, Ramp, Pulse, Noise (only for gated burst) or arbitrary waveform (except DC) to generate burst.

Subjects in this chapter:

- To Enable Burst Mode
- Burst Type
- Burst Phase
- Burst Period
- Gated Polarity
- Burst Delay
- Burst Trigger Source
- Trigger Output Edge

## To Enable Burst Mode

Press **Burst** at the front panel to enable Burst function (the backlight of the key goes on), and **Mod** or **Sweep** function will be automatically disabled (if currently enabled). The generator will output burst waveform from the corresponding channel (if currently turned on) according to the current configuration. You can also reset the burst function menu. Please refer to the introduction in the following text for details.

## Burst Type

DG4000 could output three types of bursts, including **N Cycle**, **Infinite** and **Gated**. The default is **N Cycle**.

Table 7-1 Relations among burst type, trigger source and carrier waveform

Burst Type	Trigger Source	Carrier Waveform
N Cycle	Int/Ext/Manual	Sine/Square/Ramp/Pulse/Arbitrary waveform (except DC)
Infinite	Ext/Manual	Sine/Square/Ramp/Pulse/Arbitrary waveform (except DC)
Gated	Ext	Sine/Square/Ramp/Pulse/Noise/Arbitrary waveform (except DC)

## N Cycle Burst

In N Cycle mode, the generator will output waveform with specified number of cycles after receiving trigger signal. Waveform functions that support N cycle burst include Sine, Square, Ramp, Pulse and arbitrary waveform (except DC).

For N cycle burst, "Int", "Ext" or "Manual" trigger source could be used. Besides, users can set the "**Start Phase**", "**Burst Period**" (internal trigger), "**Delay**", "**SlopeIn**" (external trigger) and "**TrigOut**" (internal and manual triggers).

When **Burst** is enabled, press **Type** to select "N\_Cyc". The parameter "Cycles" on the screen is highlighted and could be edited. At this point, use the numeric keyboard or knob to change the Cycles, the default is 1 and the available range is from 1 to 1 000 000 (external or manual trigger) or 1 to 500 000 (internal trigger).

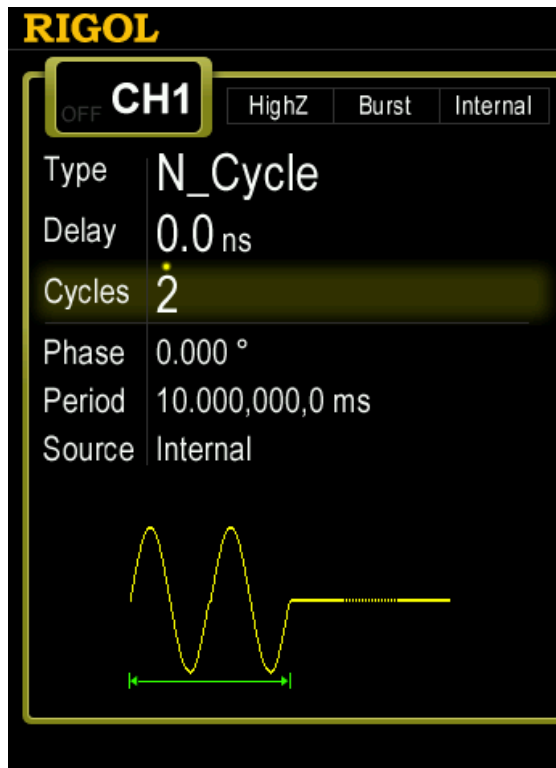

Figure 7-1 N Cycle Burst

## Infinite Burst

In Infinite mode, the cycle number of the waveform is set as an infinite value. The generator outputs a continuous waveform after receiving trigger signal. Waveform functions that support infinite burst include Sine, Square, Ramp, Pulse and arbitrary waveform (except DC).

For infinite burst, "Ext" or "Manual" trigger source could be used. Besides, users can set the "Start Phase", "Delay", "SlopeIn" (external trigger) and "TrigOut" (manual trigger).

When **Burst** is enabled, press **Type** to select "Infinite" and the instrument will set the trigger source to "Manual" automatically. An infinite cycle pulse sketch will appear on the screen.



Figure 7-2 Infinite Burst

## Gated Burst

In Gated Mode, the generator controls the waveform output according to the external signal level from the **[Mod/FSK/Trig]** connector at the rear panel. Waveform functions which support Gated Burst are Sine, Square, Ramp, Pulse, Noise and arbitrary waveforms (except DC).

When the gated signal is "True", the generator outputs a continuous waveform; when the gated signal is "False", the generator completes the current period, and then stops and holds on the voltage level corresponding to the initial burst phase



of the selected waveform. For Noise waveform, the output will stop immediately once the gated signal becomes “False”.

Gated Burst could only be triggered by “Ext” trigger source. Users can also set the “Start Phase”.

When **Burst** is enabled, press **Type** to select “Gated” and then press **Polarity** to set the gated polarity as “Pos” (or “Neg”). The generator outputs burst waveform only when the gated signal is positive.

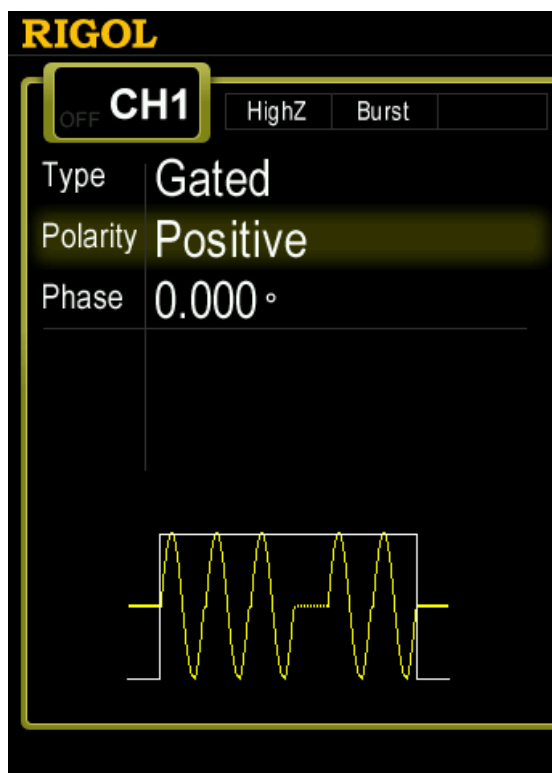

Figure 7-3 Gated Burst

## Burst Phase

Burst phase is defined as the phase of the start point of the burst.

When **Burst** is enabled, press **Start Phase** and then use the numeric keyboard or knob to input the desired phase, the default value is 0 ° and the available range is from 0 ° to 360 °.

- For Sine, Square and Ramp, 0 ° is the point where the waveform passes through 0 V (or DC offset value) positively.
- For arbitrary waveform, 0 ° is the first point of the waveform.
- For Pulse and Noise, **Start Phase** is unavailable.

## Burst Period

Burst period is only available for N cycle burst in internal trigger and is defined as the time from the start of a burst to the start of the next burst.

- Burst period  $\geq 1\mu\text{s} + \text{waveform period} \times \text{number of bursts}$ . Here, waveform period is the period of burst function (such as Sine and Square).
- If the burst period is too short, the generator will increase this period automatically to allow the output of the specified number of cycles.

When **Burst** is enabled, press **Type** → "N\_Cyc" → **Source** → "Int" → **Burst Period** and use the numeric keyboard or knob to input the desired period value. The default is 10ms, and the available range is from 2 $\mu\text{s}$  to 500s.

## Gated Polarity

Polarity is only available in gated burst mode. The instrument outputs burst when the gated signal at the **[Mod/FSK/Trig]** connector at the rear panel is "High Level" or "Low Level".

When **Burst** is enabled, press **Type** → "Gated" → **Polarity** to select "Pos" or "Neg". The default is "Pos".

## Burst Delay

Burst delay is only available for N cycle and infinite burst mode. It is defined as the time from when the generator receives the trigger signal to starts to output the N Cycle (or Infinite) burst.

When **Burst** is enabled, press **Type** → “N\_Cyc” or “Infinite”, then press  to open the 2/2 menu page and press **Delay**. Use the numeric keyboard or knob to input the desired delay. The delay is no less than 0s and no greater than 85s. The default is 0s.

## Burst Trigger Source

Burst trigger source could be internal, external or manual. The generator will generate a burst output when a trigger signal is received and then wait for the next trigger.

When **Burst** is enabled, press **Source** to select “Int”, “Ext” or “Manual”. The default setting is “Int”.

### 1. Internal Trigger

When internal trigger is selected, the generator can only output N cycle burst and the burst frequency is determined by the “Burst Period”.

### 2. External Trigger

When external trigger is selected, the generator can output N cycle, infinite or gated burst. The generator accepts the trigger signal from the **[Mod/FSK/Trig]** connector at the rear panel. A burst will be generated once the connector receives a TTL pulse with specified polarity. To set the TTL pulse polarity, press **SlopeIn** to select “Leading” or “Trailing” and the default setting is “Leading”.

Note that in “Int” and “Manual” triggers, the corresponding menu is **TrigOut**. The **[Mod/FSK/Trig]** connector at the rear panel is used as the output terminal of trigger signal.



### 3. Manual Trigger

When manual trigger is selected, the generator can output infinite or gated burst. A burst will be generated from the corresponding channel (if currently turned on) once you press **Trigger1** or **Trigger2** at the front panel. If the corresponding channel is not turned on, the trigger will be ignored.

## Trigger Output Edge

In burst mode, when the trigger source is "Int" or "Manual", the generator would output a TTL-compatible signal with specified edge from the **[Mod/FSK/Trig]** connector at the rear panel.



- In internal trigger, the generator outputs a square waveform with variable duty cycle (related to the carrier period and number of cycles) from the **[Mod/FSK/Trig]** connector at the start of burst. The trigger period is the same with the specified burst period.
- In manual trigger, the generator outputs a pulse with greater than 1 $\mu$ s pulse width from the **[Mod/FSK/Trig]** connector at the start of burst.
- In external trigger, the **[Mod/FSK/Trig]** connector is used as the input terminal of external trigger signal and has no trigger output.

When "Int" or "Manual" trigger is selected, press **TrigOut** to specify the edge of the trigger output signal and the default is "Off".

- Off: disable the trigger output signal.
- Leading: output the trigger signal at the rising edge.
- Trailing: output the trigger signal at the falling edge.



## Chapter 8 Counter

DG4000 provides a 7 digits/s counter which can measure various parameters (such as frequency, period, duty cycle, positive pulse width and negative pulse width) of external input signal and support statistic of measurement results. When the statistic function is enabled, the instrument calculates the maximum, minimum, average and standard deviation of the measurement values automatically and displays the variation tendency of the measurement values in "Digital" or "Curve" mode. In addition, the dual channels can still output normally when the counter is enabled.

Subjects in this chapter:

- To Enable the Counter
- To Set the Counter
- Statistic

## To Enable the Counter

Press **Counter** at the front panel (the backlight of the key turns on) to enable counter function and enter counter setting interface as shown in the figure below.

If the counter is currently turned on and the screen displays the counter interface, press **Counter** again to disable counter function. If the counter is currently turned on and the screen displays interfaces other than the counter interface, press **Counter** to switch to the counter interface.

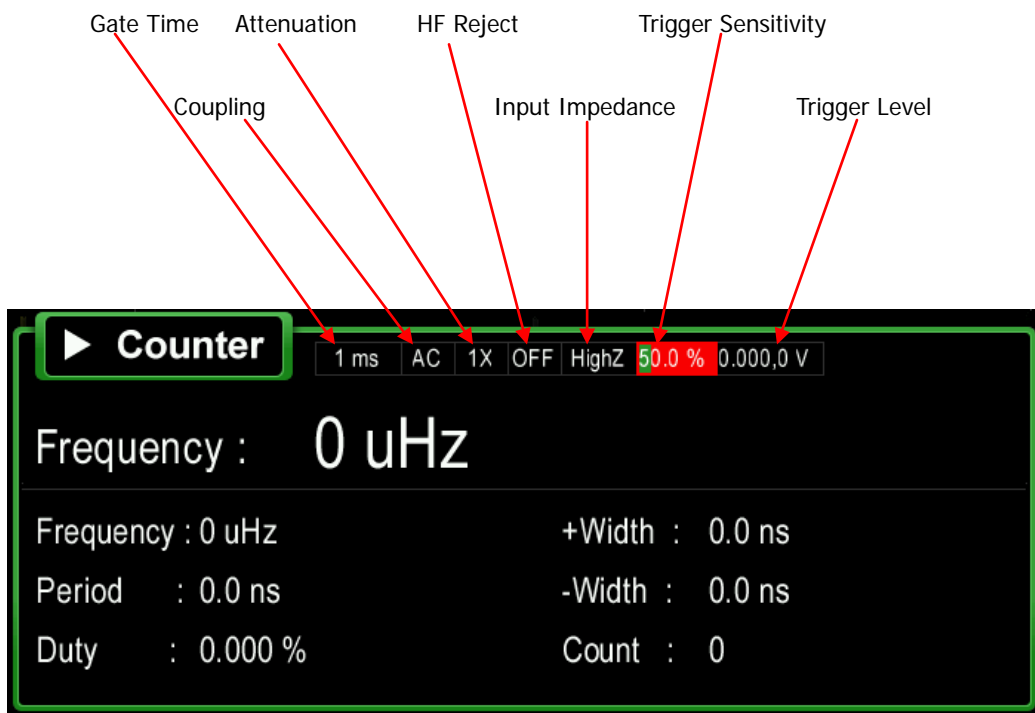

Figure 8-1 Counter Parameter Setting Interface

Note: the CH2 sync output will be disabled when the counter is enabled.



## To Set the Counter

You need to configure appropriate parameters for the counter.

### 1. TrigSens

Set the trigger sensitivity of the measurement system. The default is 50% and the range available is from 0% to 100%.

Press **TrigSens**. Use the numeric keyboard to input the desired value and select the unit “%” from the pop-up menu.

### 2. TrigLevel

Set the trigger level of the measurement system. The system triggers and gets the measurement readings when the input signal reaches the specified trigger level. The default is 0V and the range available is from -2.5V to 2.5V.

Press **TrigLevel**. Use the numeric keyboard to input the desired value and select the desired unit (V or mV) from the pop-up menu.

### 3. Impedance

Set the input impedance to “50Ω” or “HighZ” and the default is “HighZ”.

### 4. Coupling

Set the coupling mode of the input signal to “AC” or “DC” and the default is “AC”.

### 5. Atten

Set the attenuation coefficient of the input signal to “X1” or “X10”.

### 6. HFReject

High-frequency reject can be used to filter out the high-frequency components and improve the measurement accuracy in low-frequency signal measurement.

Press **HFReject** to enable or disable the high-frequency reject function.

Note: enable high-frequency reject when low-frequency signal with lower than 1kHz frequency is measured to filter out high-frequency noise interference; disable high-frequency reject when high-frequency signal with greater than 1kHz frequency is measured.

## 7. Gate Time

Press **Gate Time** to set the gate time of the measurement system and the default is "1ms".

GateT1	1ms
GateT2	10ms
GateT3	100ms
GateT4	1s
GateT5	10s
GateT6	>10s

## 8. Measure

Press **Measure** to select the type of parameter to be measured by the counter. The counter can measure the following parameters: frequency ("Freq"), period ("Peri"), duty cycle ("Duty"), positive pulse width ("+Width") and negative pulse width ("-Width") and the default is "Freq".

## 9. Statist

Press **Statist** to enable or disable statistic function. For detail information, please refer to "**Statistic**".

## 10. Auto

Press this key to set the counter parameters automatically.

After the counter parameters are set, the generator measures the external input signal using the preset parameters.

## Statistic

When the statistic function is enabled, the instrument calculates the maximum, minimum, average and standard deviation of the measurement values automatically and displays the variation tendency of the measurement values in "Digital" or "Curve" mode.

### 1. To enable the statistic

Press **Statist** → **Statist** to enable or disable statistic function and the default is "OFF".

### 2. To select display mode

After the statistic function is enabled, press **Display** to set the display mode of the statistic result to "Digital" or "Curve", as shown in Figure 8-2 and Figure 8-3.

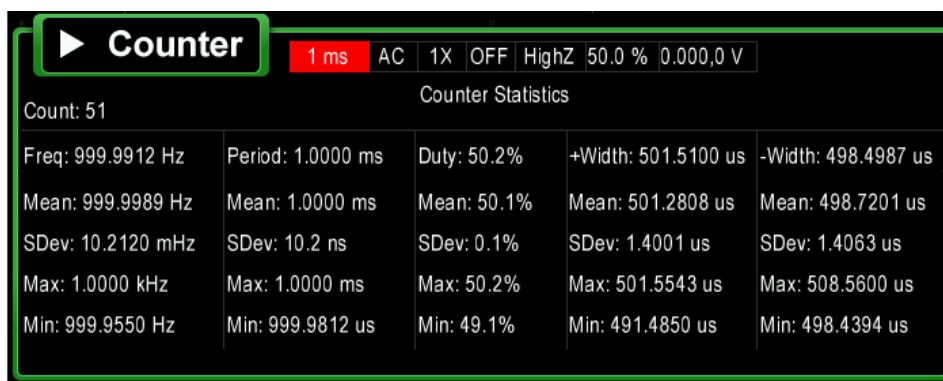

Figure 8-2 Statistic results (in "Digital" display mode)

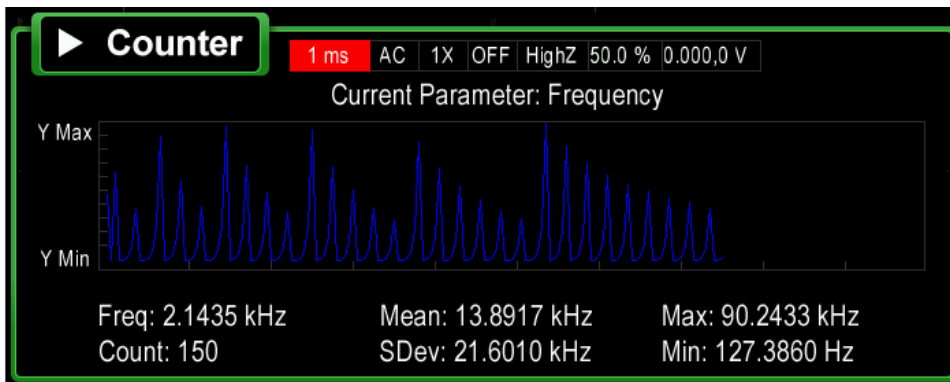

Figure 8-3 Statistic results (in "Curve" display mode)

### 3. To clear the statistic results

Press **Clear** to remove the current statistic result.

## Chapter 9 Store and Recall

DG4000 can store the current instrument state and user-defined arbitrary waveform data in internal or external memory and recall them when needed.

Subjects in this chapter:

- Storage System Overview
- To Select File Type
- To Select Browser Type
- File Operation

## Storage System Overview

DG4000 could store the current instrument state or user-defined arbitrary waveform data in internal or external memory and recall them when needed.

DG4000 provides an internal non-volatile memory (C Disk) and an external memory (D Disk).

- C Disk: provide 10 storage locations (STATE 1 to STATE 10) for state files and 10 storage locations (ARB 1 to ARB 10) for arbitrary waveform files. Users can store instrument states and arbitrary waveform files (created by users or downloaded using remote commands) to C Disk and copy the files in USB storage device to C Disk.
- D Disk: available when USB storage device is detected at the USB Host interface at the front panel.

Press **Store** (the key backlight goes on) at the front panel to enable the Store/Recall function and open the Store/Recall interface as shown in the figure below.

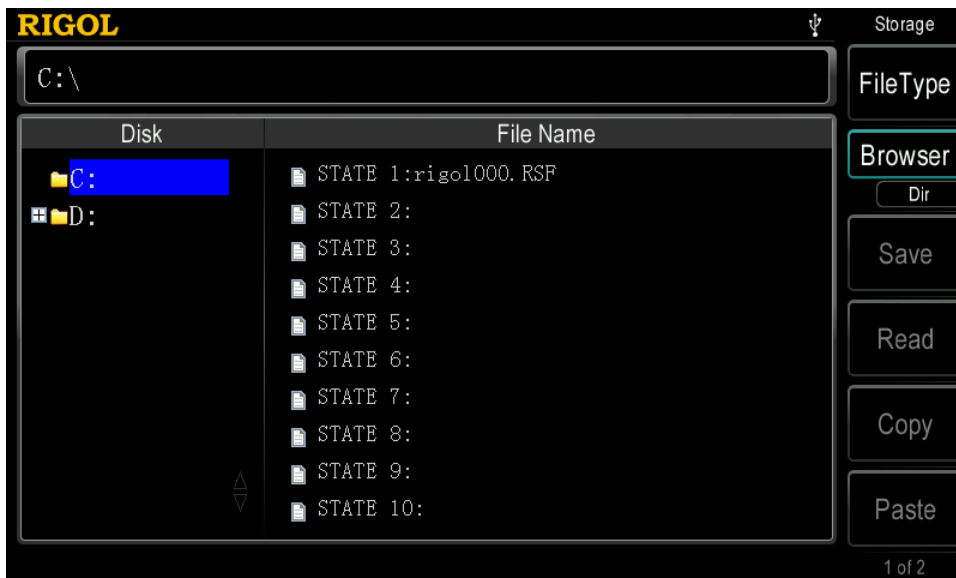

Figure 9-1 Store and Recall Interface

Note that: DG4000 can only identify filenames consist of Chinese characters, English letters, number and underscore. If other characters are used to name the file or folder, the name might be displayed in the store and recall interface abnormally.

## To Select File Type

Press **Store** → **File Type** to select the desired file type. The file types available include State File, Arb File, Txt File, Csv File and All File.

### 1. State File

Store the instrument state in internal or external memory in "\*.RSF" format. At most 10 instrument states can be stored in internal memory. The 10 instrument states stored correspond to "User1" to "User10" in **Utility** → **Preset** (refer to **Restore Default**).

The state file stored includes waveforms selected, frequency, amplitude, DC offset, duty cycle, symmetry, phase and modulation, sweep, burst parameters used of the two channels and counter parameters.

### 2. Arb File

Store the user-defined arbitrary waveform in internal or external memory in "\*.RAF" format. At most 10 arbitrary files can be stored in internal memory.

### 3. Txt File

Read the Txt files stored in external memory. The data of each line (can not be longer than 64 characters) is considered as an arbitrary waveform point and the data of all the lines in the file are normalized to form an arbitrary waveform. The arbitrary waveform is stored in volatile memory. The instrument will enter the **Arb** interface automatically when the "Read" operation is finished.

Note: when "Dir" is selected in **Browser**, this menu is grayed out and disabled.

### 4. Csv File

Read the csv files in external memory. The instrument will enter the **Arb** interface automatically when the "Read" operation is finished. The arbitrary waveform is stored in volatile memory.

Note: when "Dir" is selected in **Browser**, this menu is grayed out and disabled.



## 5. All File

Display all the files and folders in the currently selected directory. When this menu is selected, the store function is not available.

## To Select Browser Type

Press **Store** → **Browser** to switch between “Dir” and “File”. Use the knob to select the desired directory or file.

- Dir: when this type is selected, use the knob to switch between C Disk and D Disk (when USB storage device is inserted).
- File: when this type is selected, use the knob to switch files or folders under the current directory.

# File Operation

When “File” is select as the browser type, users can perform a series of operations on files including Save, Read, Copy, Paste, Delete and New Directory.

## Save

### 1. To Select File Type

Follow the introduction in **To Select File Type** to select the type of files to be saved. Note that if the current **File Type** is “All File”, the save operation is unavailable.

### 2. To Open the Filename Input Interface

In Store/Recall interface, set the **Browser** as “File” and then press **Save** to enter the filename input interface as shown in the figure below.

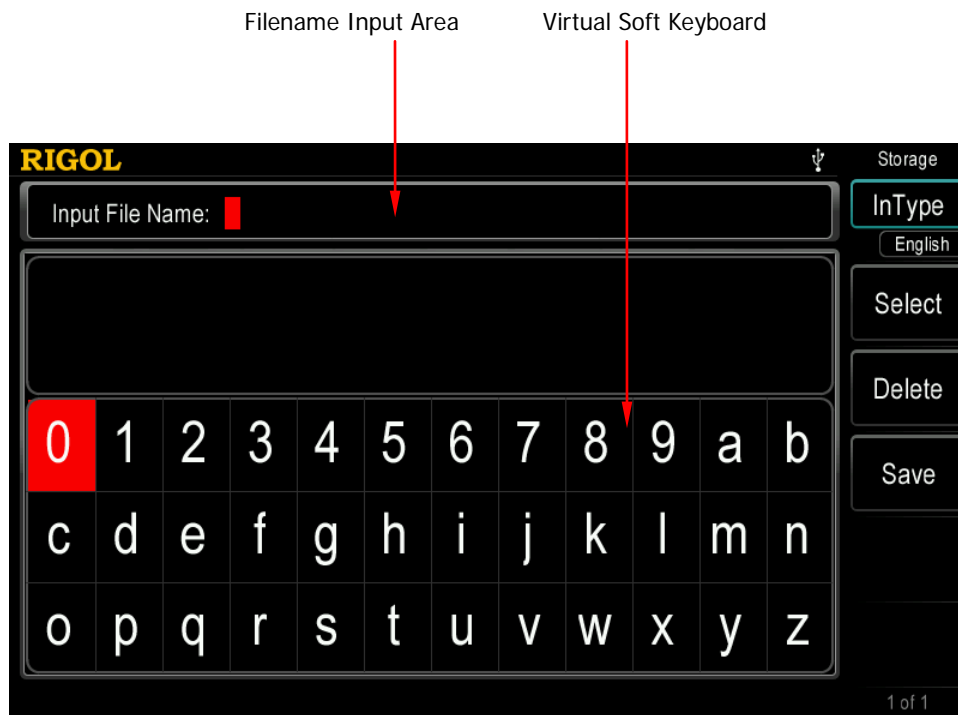

Figure 9-2 Filename Input Interface (English)

### 3. To Input Filename

Press **InType** to select “Chinese” or “English”. The length of the file or folder name is limited within 27 characters.

- English Input (include number input):  
Press **+/-** on the numeric keyboard to switch between uppercase and lowercase.

Use the knob to select the desired character from the “virtual soft keyboard”, then press **Select** to select the character and the character selected would be displayed in the “Filename Input Area”. Use the same method to input all the characters needed. You can press **Delete** to delete the character at the cursor currently in the “Filename Input Area”.

- Chinese Input:  
Press **+/-** on the numeric keyboard to switch to lowercase.

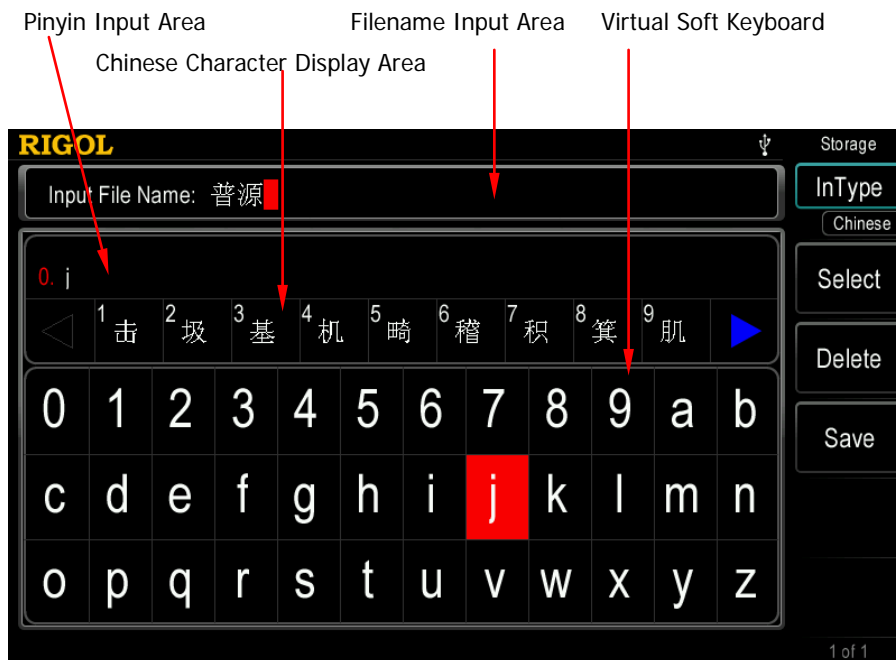

Figure 9-3 Filename Input Area (Chinese)

Use the knob to select the desired character from the “virtual soft keyboard”, then press **Select** to select the character and the character

selected would be displayed in the “Pinyin Input Area”. After inputting the pinyin of a Chinese character, use the numeric keyboard to select the No. of the desired Chinese character (if the desired Chinese character is not currently displayed, use the direction key to open the next page) and the Chinese character selected would be displayed in the “Filename Input Area”. Use the same method to input all the Chinese characters needed. You can press **Delete** to delete the character in the “Pinyin Input Area” and then the Chinese character at the cursor currently in the “Filename Input Area”.

#### 4. To Save File

After finishing inputting filename in the filename input interface, press **Save**, the generator will save the file under the currently selected directory with the specified filename and file type and display corresponding prompt message when the save operation succeeds.

## Recall

### 1. To Select File Type

Follow the introduction in **To Select File Type** to select the type of file to be recalled. Note that if the current **File Type** is “All File”, the file to be recalled is the currently selected file.

### 2. To Select the File to be Recalled

Set **Browser** as “Dir” and use the knob to select the directory in which the file to be recalled is stored. Then set **Browser** as “File”, and use the knob to select the file to be recalled.

### 3. To Recall File

Press **Read**, the generator will read the currently selected file and display corresponding prompt message when the read operation succeeds.

## Copy

### 1. To Select the File to be Copied

Set **Browser** as "Dir" and use the knob to select the directory in which the file to be copied is stored. Then set **Browser** as "File", and use the knob to select the file to be copied.

### 2. To Copy File

Press **Copy**, the generator will copy the file currently selected.

## Paste

### 1. To Copy a File

Copy a file following the introduction in **Copy**.

### 2. To Select Paste Destination

Set **Browser** as "Dir" and use the knob to select a paste destination directory.

### 3. To Paste File

Press **Paste**, the generator will paste the copied file in the directory currently marked by the cursor and display corresponding prompt message when the paste operation succeeds.

## Delete

### 1. To Select File or Folder to be Deleted

Set **Browser** as "Dir" and use the knob to select the directory in which the file or folder to be deleted is stored. Then set **Browser** as "File", and use the knob to select the file or folder to be deleted.

### 2. To Delete File or Folder

Press **Delete**, the generator will delete the currently selected file or folder (empty folder).

## New Directory

DG4000 allows users to create new folders in external memory. Please make sure that a USB storage device is inserted and identified by the instrument.

### 1. To Select Memory

In Store/Recall interface, set **Browser** as "Dir" and use the knob to select "D disk".

### 2. New Directory

Set **Browser** as "File", use  to open the 2/2 menu page and press **New Directory** to enter the folder name input interface ( same as shown in **Figure 9-2** or **Figure 9-3**).

Note: when "C Disk" is selected, this menu is unavailable.

### 3. To Input Folder Name

Input the new folder name following the introduction in **Save**.

### 4. To Save Folder

After finishing inputting the new folder name in the folder name input interface, press **Save** and the generator will create a new empty folder under the current directory.

# Chapter 10 Utility and System Settings

DG4000 allows users to configure the parameters of dual channels, configure remote interfaces and set system parameters.

Subjects in this chapter:

- Overview
- Channel Setting
- To Use the External Power Amplifier (Option)
- To Configure the Remote Interface
- System Setting
- Print
- Test/Cal
- Channel Coupling
- Channel Copy
- User-defined Waveform Key
- Restore Default

## Overview

Press **Utility** at the front panel to open the operation interface as shown in the figure below. This interface displays the current channel output configuration, channel coupling configuration and system parameters.



Figure 10-1 Utility Interface

1. **CH1Set:** set the output parameters of CH1.
2. **CH2Set:** set the output parameters of CH2.
3. **PA Setup:** set the external power amplifier parameters (only available when the external power amplifier is connected).
4. **I/O Setup:** set the remote control interface parameters.
5. **System:** set the system parameters.
6. **Print:** set parameters related to screen print.
7. **Test/Cal:** calibrate DG4000 manually.
8. **Coupling:** set channel coupling parameters.
9. **CH Copy:** set channel copy parameters.
10. **UserKey:** define the shortcut of frequently used built-in waveform.
11. **Preset:** restore the generator to its default state or user-preset states.



## Channel Setting

This section takes CH1 for example to illustrate how to set the channel. The setting method for CH2 is quite the same.

### Sync

DG4000 could output the sync signals of basic waveforms (except Noise), arbitrary waveforms (except DC), Harmonics, Sweep signal, Burst signal and modulated signal from a single channel or two channels at the same time. The sync signal is output from the **[Sync]** connector at the front panel.

#### 1. Sync On/Off

Enable or disable sync signal at the **[Sync]** connector. Press **Utility** → **CH1Set** → **Sync** to select "On" or "Off" for the sync signal output. The default is "On", namely transmitting the sync signal to the **[Sync]** connector. If sync signal is disabled, the output level at the **[Sync]** connector is logic low.

#### 2. Sync Signals of Various Waveforms

- For Sine, Square, Ramp and Pulse, the sync signal is a Square with 50% duty cycle. It is TTL high level relative to 0V (or DC offset) when the output is positive and TTL low level relative to 0V (or DC offset) when the output is negative.
- For arbitrary waveform, the sync signal is a square with 50% duty cycle. The sync signal is TTL high level when the generator outputs the first downloaded waveform point.
- For harmonics, sync signal is a square with variable duty cycle and takes the harmonic order as reference.
- For AM, FM, PM and PWM, in internal modulation mode, the sync signal is a Square with 50% duty cycle and takes modulating frequency as reference. It is TTL high level in the first half period of the modulation waveform. In external modulation mode, there is no sync signal output.
- For ASK, FSK, PSK, BPSK, QPSK, 3FSK and 4FSK, the sync signal takes ASK/FSK/PSK/BPSK/QPSK/3FSK/4FSK Rate as reference and is a Square

with 50% duty cycle. For ASK, FSK and PSK, in external modulation mode, there is no sync signal output.

- For OSK, the sync signal is a square with 50% duty cycle and takes OSK rate as reference. The sync signal is TTL high level when the internal crystal oscillator starts to oscillate. In external modulation mode, there is no sync signal output.
- For Sweep, when "Mark" is disabled, the sync signal is a Square with 50% duty cycle. It is TTL high level at the start of the sweep and changes to TTL low level at mid-point of the Sweep and its frequency corresponds to the specified sweep time, return time, start hold and end hold times. When "Mark" is enabled, the sync signal is TTL high level when sweep starts and transforms to TTL low level at the marked frequency point.
- For a N cycle burst, the sync signal is TTL high level when burst starts and transforms to TTL low level while the specified number of cycles end (if the waveform has a relative start phase, the crossing point may not be zero). For an infinite burst, its sync signal is the same as the sync signal of a continuous waveform.
- For an external Gated burst, its sync signal follows its gated signal. Note that the sync signal will not transform to TTL low level until the last period is finished (if the waveform has a relative start phase, the crossing point may not be zero).

## Sync Polarity

Set the sync signal on the **[Sync]** connector as normal or inverted.

Press **Utility** → **CH1Set** → **Polarity** to select "Pos" or "Neg".

- Pos: output normal sync signal.
- Neg: output inverted sync signal.

Notice that the sync signal related to the waveform is not inverted even when the waveform is inverted.

## Output Polarity

Set the signal on the **[Output1]** connector as normal or inverted. Waveform inverts relatively to the offset voltage.

Press **Utility** → **CH1Set** → **Output** to select "Normal" or "Invert". The default is "Normal". The waveform of the first half period of the cycle is positive in "Normal" mode and negative in "Invert" mode.

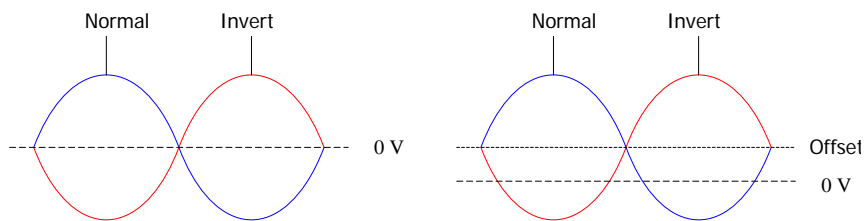

Pay attention to the following after the waveform inverts:

- None of the offset voltage would change.
- Waveform is not inverted in graphic mode.
- Sync signal related to the waveform is not inverted.

## Resistance Setting

Resistance setting is applicable to output amplitude and DC offset voltage. DG4000 has a  $50\Omega$  fixed serial output resistance for the **[Output1]** connector at the front panel. If the actual load does not match the specified value, the voltage level displayed would not match the voltage level of the component under test. To ensure correct voltage level, the load resistance setting must match the actual load.

Press **Utility** → **CH1Set** → **Resi** to select "HighZ" or "Load". The default is "HighZ". If "Load" is selected, use the numeric keyboard to set specific resistance value. The default is  $50\Omega$  and the available range is from  $1\Omega$  to  $10k\Omega$ . Resistance setting will be displayed on the screen. As shown in the figure below, CH1 resistance setting is a specified value " $50\Omega$ " and CH2 resistance setting is "HighZ".

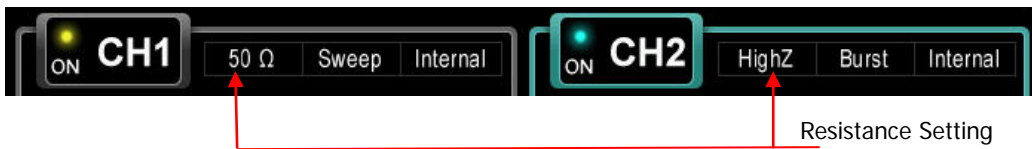

Figure 10-2 Resistance Setting

The generator will adjust the output amplitude and offset voltage automatically once the resistance setting is changed. For example, the current amplitude is 5Vpp. At this point, change the output resistance from 50Ω to HighZ and the amplitude displayed on the screen will double to 10Vpp. If the output resistance is changed from HighZ to 50Ω, the amplitude will reduce to half of the previous value (2.5Vpp). Notice that only the displayed values change with the parameter and the real output from the generator does not change.

## Noise Setting

DG4000 supports to superpose a gauss noise onto its output signal. This function is called noise superposition. The signal superposed with noise can be used to test the anti-noise capability of instrument.

Press **Utility** → **CH1Set** → **Noise** to enable or disable noise superposition function. The default is "OFF". When Mod, Sweep or Burst is enabled, this menu is grayed out and disabled.

## Noise Scale

Set the percentage of the amplitude of the noise superposed onto the output signal takes up in the signal amplitude.

Press **Utility** → **CH1Set** → **Noise Scale**. Use the numeric keyboard to input the desired value and select the unit "%" from the unit menu. The range available is from 0% to 50% and the default is 10%. Note that **Noise Scale** is grayed out and disabled when noise superposition function is disabled.

## To Use the External Power Amplifier (Option)

You can connect external power amplifier to DG4000 and set the power amplifier parameters to amplify the signal before output. To use the external power amplifier, install the PA1011 option.

PA1011 is an optional accessory for **RIGOL** DG series function/arbitrary waveform generators. PA1011 provides 1MHz maximum full power bandwidth and greater than 80V/ $\mu$ s output slew rate. It can be used with any of the DG series products to quickly build test platform or be used with other signal generators as an independent power amplifier.

### Main features of PA1011:

- Flexible and easy communication with the **RIGOL** DG series signal generator or PC via the USB interface.
- Users can set the gain (X1 or X10), polarity (normal or invert), output offset and output switch of the amplifier via the **RIGOL** DG series signal generator or the PC software.
- Provide up to 50k $\Omega$  input impedance.
- An integrated output protection circuit (output overcurrent protection and internal temperature abnormality protection) ensures the stable, reliable and safe operation of the instrument.
- Small in size, portable and easy to use.

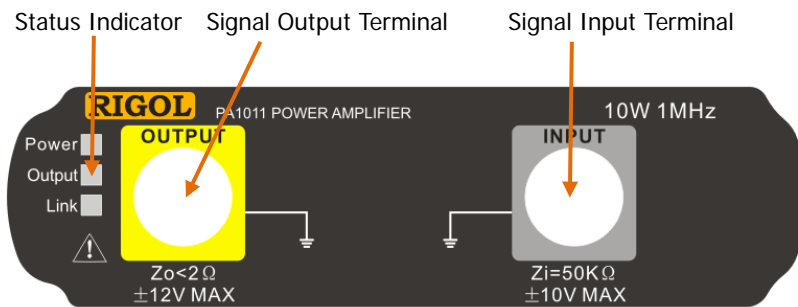
**Front Panel:****Status Indicator**

Power: illuminated in red indicating that the power is successfully connected.

Output: illuminated in green indicating that the output is enabled.

Link: illuminated in yellow indicating that the USB connection is successful.

**CAUTION**

The input impedance of the instrument ( $Z_i$ ) is 50k $\Omega$ . The range of the input voltage is from -10V to +10V when the voltage gain is X1 and from -1.25V to +1.25V when the voltage gain is X10. When the input exceeds these ranges, the instrument might be damaged or hazardous might occur.

**CAUTION**

The output impedance of the instrument ( $Z_o$ ) is less than 2 $\Omega$ . The range of the output voltage is from -12V to +12V. The actual output voltage can reach  $\pm 12.5V$ , but the total harmonic distortion of the waveform will increase.

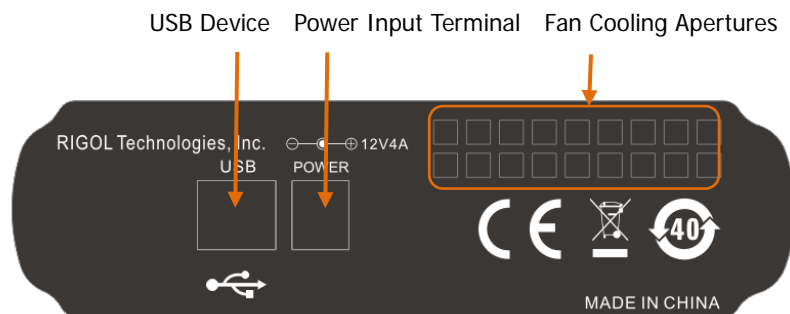
**Rear Panel:****CAUTION**

Do not use other type of adapter to provide power for PA1011; otherwise, the instrument performance might be affected or the instrument might be permanently damaged.

**CAUTION**

Make sure that the vents at the side and the fan cooling apertures at the rear panel of PA1011 are not blocked during operation to avoid affecting the normal operation of the instrument.

**PA1011 Accessories:**

Name	Qty.	Explanation
Power Cord	1	Connect AC power to the power adapter.
Power Adapter	1	Output 12V, 4A signal.
USB Cable	1	Connect PA1011 and DG4000.
BNC Cable	1	Connect PA1011 and DG4000.
CD	1	Provide the PC software installation program of PA1011.

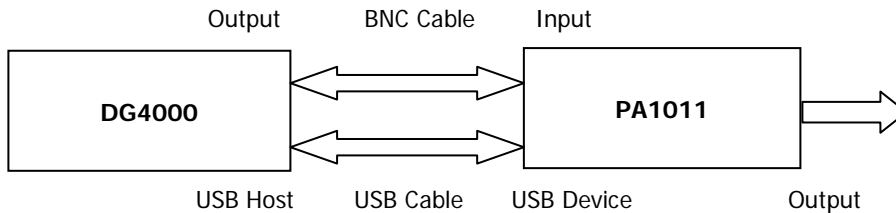
**Connect DG4000 and PA1011:**

After the power amplifier is successfully connected, press **Utility** → **PA Setup** to open the parameter setting interface of the power amplifier.

**1. Switch**

Press this key to enable or disable the external power amplifier. When enabled, PA amplifies the input signal and then output it. When disabled, there is no output from PA.

**2. Gain**

Press this key to set the amplification gain of the signal output from the power amplifier to "X1" or "X10". Wherein, "X1" indicates output without gain and "X10" indicate amplifying the signal for 10 times and then output it.

**3. Output**

Press this key to set the output signal of the power amplifier to "Normal" or "Invert".

**4. Offset**

Press this key to enable or disable the output offset at the output terminal of the power amplifier. When it is enabled, use the numeric keyboard or knob to set the offset and the range is from -12V to +12V (the default is 0V).

**5. Store**

Press this key to store the current working state of the power amplifier to its internal memory. When the power amplifier is enabled the next time, it will automatically recall the last working state stored.



**Tip**

For the specifications of PA1011, refer to Appendix B.

## To Configure the Remote Interface

DG4000 is configured with USB and LAN interfaces and supports users to configure the interface parameters for remote communication.

Press **Utility** → **I/O Setup** to open the I/O setting menu and set the LAN interface parameters for remote communication or select the type of device connected to the USB interface.

## LAN Setting

Press **Utility** → **I/O Setup** → **LAN** to open the LAN parameters configuration interface as shown in the following figure. Users can examine network status and configure network parameters.

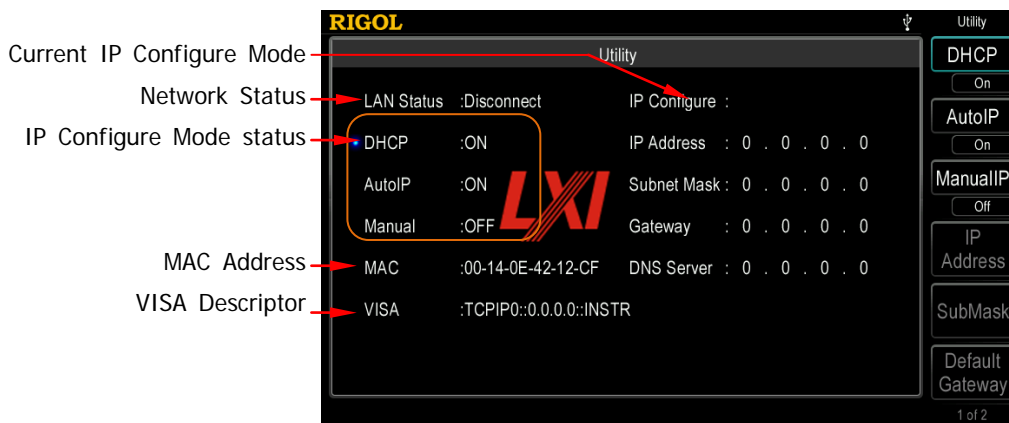

Figure 10-3 LAN Setting Interface

## Network Status

Different prompt messages will be provided by the generator based on the current network status.

- Connected: LAN connection is successful.
- Disconnect: LAN connection is unsuccessful.

## MAC Address

MAC (Media Access Control) address, also called hardware address, is used for defining the position of the network device. For a generator, the MAC address is always unique. It is always used to identify the instrument while assigning IP address for instrument. MAC address (48 bits, namely 6 bytes) is usually expressed in hexadecimal format, such as 00-14-0E-42-12-CF.

## VISA Descriptor

VISA (Virtual Instrument Software Architecture) is an advanced application programming interface developed by NI (National Instrument) for communications with various instrument buses. It uses the same method to communicate with instruments regardless of the types of the instrument interfaces (GPIB, USB, LAN/Ethernet or RS232). The GPIB, USB, LAN/Ethernet or RS232 instrument is called "resource".

VISA descriptor is the resource name and describes the accurate name and location of the VISA resource. If LAN interface is currently used for communication with the instrument, the VISA descriptor is TCPIP0::172.16.2.13::INSTR.

## IP Configure Mode

IP configure mode could be DHCP, AutoIP or ManualIP. If the network is disconnected currently, there will be nothing to display behind "IP Configure Mode:". In different IP configuration modes, the configuration modes of network parameters (such as IP address) are different.

### 1. DHCP

- In DHCP mode, DHCP server in the current network assigns LAN parameters, e.g. IP address, for the generator.
- Press **DHCP** to select "On" or "Off" to turn DHCP mode on or off.

### 2. AutoIP

- In AutoIP mode, the generator acquires IP address within 169.254.0.1

and 169.254.255.254 and subnet mask 255.255.0.0 automatically according to the current network configuration.

- Press **AutoIP** to select "On" or "Off" to turn AutoIP mode on or off. To enable this mode, set **DHCP** as "Off".

### 3. ManualIP

- In ManualIP mode, the LAN parameters of the generator, e.g. IP address, are defined by users.
- Press **ManualIP** to select "On" or "Off" to turn ManualIP mode on or off. To enable this mode, set **DHCP** and **AutoIP** as "Off".
- The IP address format is nnn.nnn.nnn.nnn. The first nnn ranges from 0 to 223 (except 127) and the other three nnn range from 0 to 255. It is recommended that users acquire an available IP from their network administrator.
- Press **IP Address** and use the numeric keyboard and direction keys to enter your desired IP. The setting is stored in non-volatile memory and will be loaded automatically when the generator is powered on the next time if DHCP and AutoIP are set as "Off".

#### Tips

- If all the three IP configuration modes are "On", the priority of parameters configuration from high to low is "DHCP", "AutoIP" and "ManualIP".
- The three IP configuration modes cannot be set as "Off" at the same time.

## To Set Subnet Mask

In ManualIP mode, the subnet mask could be manually set.

- The format of subnet mask is nnn.nnn.nnn.nnn, where nnn ranges from 0 to 255. It is recommended that users acquire an available subnet mask from their network administrator.
- Press **SubMask** and use the numeric keyboard and direction keys to enter your desired subnet mask. The setting is stored in non-volatile memory and will be automatically loaded when the generator is powered on the next time if DHCP and AutoIP are set as "Off".

## To Set Default Gateway

In ManualIP mode, the default gateway could be manually set.

- The format of default gateway is nnn.nnn.nnn.nnn, where the first nnn ranges from 0 to 223 (except 127) and the other three nnn range from 0 to 255. It is recommended that users acquire an available default gateway from their network administrator.
- Press **Default Gateway** and use the numeric keyboard and direction keys to enter your desired gateway address. The setting is stored in non-volatile memory and will be automatically loaded when the generator is powered on the next time if **DHCP** and **AutoIP** are set as "Off".

## To Set Domain Name Server (DNS)

In ManualIP mode, the DNS could be manually set.

- The DNS format is nnn.nnn.nnn.nnn, where the first nnn ranges from 0 to 223 (except 127) and the other three nnn range from 0 to 255. It is recommended that users acquire an available DNS address from their network administrator.
- Press **DNS Server** and use the numeric keyboard and direction keys to enter your desired DNS address. The setting is stored in non-volatile memory and will be automatically loaded when the generator is powered on the next time if **DHCP** and **AutoIP** are set as "Off".

## Default Configuration

Press **Default Config** and the prompt message “Restore network settings to preset values of LXI?” is displayed. Press **OK** to restore the network parameters to their default values. By default, DHCP and AutoIP are enabled and ManualIP is disabled.

## Current Configuration

Press **Current Config** to examine the MAC address of the current instrument, the current LAN parameters and LAN status information.

## OK

Press **Ok** to enable the current setting of LAN parameters.

## To Set USB Device Type

The USB Device interface at DG4000 rear panel could be connected with PC or PictBridge printer to control the instrument remotely or to print the contents displayed on the screen.

Press **Utility** → **I/O Setup** → **USB Dev**:

- Select "PC": users can use PC software to edit arbitrary waveform and download it to the internal memory of the generator. Users can also use the SCPI commands to control the generator.
- Select "Printer": press **Utility** → **Print** → **Dest** to select "Printer". Users can press **Print** to print the contents currently displayed in the interface.







## System Setting

### Number Format

You can set the display formats of the decimal point and thousands separator in number parameters. This setting is stored in non-volatile memory. Press **Utility** → **System** → **Number Format** to enter the number format setting interface.

- Decimal Point: could be set as dot "." or comma "," and the default is dot ".".
- Thousands separator: could be set as "On", "Off" or "Space". The default is "On".

Number format has 6 combinations, as shown in the figure below:

	Dot + On (Comma)
	Dot + Space
	Dot + Off
	Comma + On (Dot)
	Comma + Space
	Comma + Off

**Note:** Decimal point and thousands separator cannot be set as dot or comma at the same time.



## Language

At present, DG4000 supports simplified Chinese and English system languages, including Chinese/English menu, help information, prompt messages, interface display and Chinese/English input method.

Press **Utility** → **System** → **Language** to select the desired language. This setting is stored in non-volatile memory and will not be influenced by “Preset”.

## Power On Setting

Set the configuration to be used when the instrument is powered on the next time to “Default” or “Last”. The default setting is “Default”.

- Last: include all the system parameters, except output configuration, clock source.
- Default: denote the factory default except some parameters (such as: Language).

Press **Utility** → **System** → **PowerOn** to select the desired configuration type. This setting is stored in non-volatile memory and will not be influenced by “Preset”.

## Power Setting

Set the start-up mode when the generator is powered on to “Auto” or “Manual” and the default is “Auto”.

- Auto: the instrument starts automatically after power-on.
- Manual: users need to press the power switch at the front panel to start the instrument after power-on.

Press **Utility** → **System** → **PowerSet** to select the desired type.

## Brightness

Press **Utility** → **System** → **Light** and use the numeric keyboard or knob to set the brightness of the screen. The range is from 1% to 100%. This setting is stored in non-volatile memory and will not be influenced by "Preset".

## Beeper

When the beeper in DG4000 is enabled, a beep is generated when an error occurs during front panel or remote operation.

Press **Utility** → **System** → **Beep** to select "On" or "Off" and the default is "On". The current setting is stored in non-volatile memory and will not be influenced by "Preset".

## Screen Saver

Enable or disable screen saver mode.

Press **Utility** → **System** → **ScrnSvr** to select "On" or "Off" and the default is "Off". The current setting is stored in non-volatile memory and will not be influenced by "Preset".

## Clock Source

DG4000 provides internal 10MHz clock source and accepts external clock source from the **[10MHz In/Out]** connector at the rear panel. It can also output clock source from the **[10MHz In/Out]** connector.

Press **Utility** → **System** → **CLK** to select "Int" or "Ext". The default is "Int". If

“Ext” is selected, the instrument will detect whether a valid external clock signal is input from the **[10MHz Out/In]** connector at the rear panel. If no valid clock source is detected, the prompt message “Not detect a valid external clock!” would be displayed and the clock source would be switched to “Int”.

Users can also synchronize two or more instruments by setting the clock source. When two instruments are synchronized, the “Align Phase” function can not be used. “Align phase” is only applicable to be used to adjust the phase relation between two output channels of the same instrument and can not be used to change the phase relation between the output channels of two instruments. Users can change the phase relation between two instruments by change the “Start Phase” of each channel.

#### **Sync methods for two or more instruments:**

- Synchronization between two instruments:  
Connect the **[10MHz In/Out]** connector of Generator A (“Internal” clock) to the **[10MHz In/Out]** connector of Generator B (“External” clock) and set the output frequencies of A and B as a same value to realize synchronization between two instruments.
- Synchronization among multi-instruments (Method 1):  
Connect the **[10MHz In/Out]** connector of Generator A (“Internal” clock) to the **[10MHz In/Out]** connector of Generator B (“External” clock), then connect the **[10MHz In/Out]** connector of Generator B with the **[10MHz In/Out]** connector of Generator C (“External” clock), etc. Finally, set the output frequencies of all the generators as a same value to realize synchronization among multi-instruments.
- Synchronization among multi-instruments (Method 2):  
Divide the 10MHz clock source of a Generator (“Internal” clock) into multiple channels, and then connect them to the **[10MHz In/Out]** connectors of other generators (“External” clock) respectively, and finally set the output frequencies of all the generators as a same value to realize synchronization among multi-instruments.

## System Information

Press **Utility** → **System** → **Sys Info** and the model, serial number, software, FPGA, hardware and keyboard version numbers are displayed in the system information interface.

# Print

Users could store the contents displayed on the screen into external USB storage device in picture format or print them via PictBridge printer. Press **Utility** → **Print** to open the print setting interface.

## 1. To Print the Screen Using PictBridge Printer

First, connect the pictBridge printer. Connect the USB Device interface of the signal generator to the USB Host interface of the Printer using USB cable (as shown in the figure below).

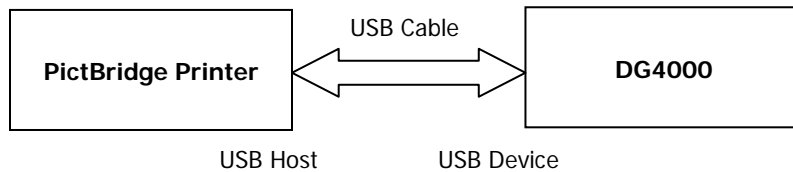

Press **Utility** → **I/O Setup** → **USB Dev** to set the device type to “Printer”. Press **Utility** → **Print** → **Dest** to select “Printer”. Then, press **PictBridge** to enter the print setting menu.

- **Copies:** press this softkey and use the knob to input the number of copies to be printed. The range is from 1 to 1000.
- **Palette:** press this softkey to set the color of the image to “Gray” or “Color”.
- **Inverted:** press this softkey to enable or disable inverted print.

## 2. To Store Screen to USB Storage Device

Please connect a USB storage device first. When the connection succeeds, an



icon will be displayed in the status bar on the screen and the corresponding prompt message will be displayed.

Press **Utility** → **Print** → **Dest** to select “U Disk” and then press **Format** to set to store the screen picture in “Bmp” or “Jpeg” format.

## 3. To Execute Print

Press **Print** at the front panel and the generator will print the screen via the PictBridge printer or store the screen in USB storage device in picture format according to the preset configuration.

Note: if no PictBridge printer is currently connected to the generator or no USB storage device is detected, the print operation would fail and the prompt message "PictBridge equipment is not connected." or "USB flash driver not detected. Print invalid." would be displayed.

## Test/Cal

Press **Utility** at the front panel, use  to select the 2/2 page menu and press **Test/Cal** to open the Test/Cal interface. You can calibrate DG4000 manually after inputting the correct calibration password.

### 1. Secure Code

Press this key and use the knob and direction keys to enter the correct calibration password.

### 2. Secure

By default, this menu is "On". It will be "Off" only when the correct calibration password is entered.

### 3. CaliSelf

This menu is available after the correct calibration password is entered. You can refer to the DG4000 Calibration Guide to calibrate the instrument manually.

### 4. Preset

Press this softkey and the calibration values are restored to their default values.

Note: manual calibration by users is not recommended. If calibration is required, please contact **RIGOL** customer service department or the local distributor.

## Channel Coupling

DG4000 supports to enable frequency, phase and amplitude couplings separately or at the same time. When coupling is enabled, set CH1 or CH2 as the “base” channel and set the frequency, phase or amplitude deviation of the two channels. Then when the frequency, phase or amplitude of the base channel is changed, the corresponding parameter of the other channel will change automatically and always keeps the specified frequency, phase or amplitude deviation.

Press **Utility** at the front panel, use  to open the 2/2 menu page and press **Coupling** to enter the channel coupling interface.

### 1. To Set the Coupling Base

Press **Base** to set “CH1” or “CH2” as the base source of coupling. Here, “CH2” is selected.

Note that the coupling base can not be changed when the coupling function is enabled. At this point, this menu is grayed out and disabled.

### 2. To Enable Coupling Function

Press **Coupling** to turn “On” or “Off” the coupling function. The default is “Off”.

Press **FreqCoup** to turn frequency coupling “On” or “Off”. After frequency coupling is enabled, use the numeric keyboard to input the desired frequency deviation. Here, it is set to “100Hz”.

Press **PhaseCou** to turn phase coupling “On” or “Off”. After phase coupling is enabled, use the numeric keyboard to input the desired phase deviation. Here, it is set to “10°”.

Press **AmpCoup** to turn amplitude coupling “On” or “Off”. After amplitude coupling is enabled, use the numeric keyboard to input the desired amplitude deviation. Here, it is set to “1Vpp”.

Parameter relations between CH1 and CH2:

$$F_{CH1}=F_{CH2} + 100\text{Hz} \quad P_{CH1}=P_{CH2} + 10^\circ \quad A_{CH1}=A_{CH2} + 1\text{Vpp}$$

Green “\*” marks are displayed on the left of the frequency, phase and amplitude of the coupling base source as shown in the figure below, indicating that the



generator is in frequency, phase and amplitude couplings. Change the frequency, phase and amplitude of CH2 to 100Hz, 0° and 1Vpp respectively and the parameters of CH1 will change to 200Hz, 10° and 2Vpp automatically.

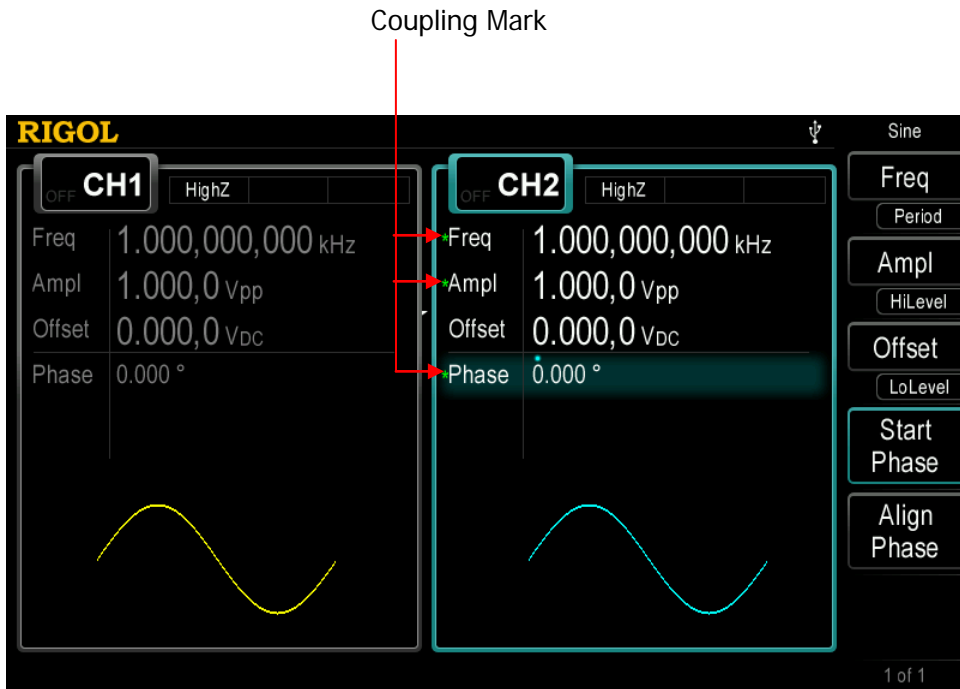

Figure 10-4 Channel Coupling

### Key Points:

- Channel coupling is only available when the waveforms of the two channels are basic waveforms, including Sine, Square, Ramp and Arbitrary waveform (except DC).
- If the sum of the frequency, phase or amplitude of the base channel and the corresponding deviation set exceeds the upper limit of frequency, phase or amplitude of the non-base channel, the generator will adjust the frequency, phase or amplitude of the non-base channel to avoid parameter overrange.
- The frequency, phase and amplitude of the non-base channel can not be modified directly.
- When the phase of the base channel is changed, the phase (phase displayed on the interface) of the non-base channel will change accordingly. At this point, align phase between the two channels can be realized without executing the **Align Phase** operation.

- Channel coupling and channel copy are mutually exclusive. The prompt message "Channel copy not allowed in Coupling mode." would be displayed if users execute channel copy operation (press **CH1=CH2** at the front panel) when channel coupling is enabled.

## Channel Copy

DG4000 supports state copy or waveform copy function between its two channels, namely copy the state (parameters and output configuration) or arbitrary waveform parameters of one channel to the other or swap the states of the two channels.

Press **Utility** → **CH Copy** to set the parameters of channel copy. This setting will not be affected by the preset operation.

### 1. Copy Type

Press **Utility** → **CH Copy** → **Type** at the front panel to set the content of channel copy to "State" or "Wave".

- State: include waveform (except volatile waveform) and waveform parameters (such as frequency and amplitude), functions (such as modulation, sweep and burst) as well as output configurations (such as sync, resistance and polarity) of the channel.
- Wave: arbitrary waveform data (except waveform parameters). Available only when both of the two channels select arbitrary waveforms.

### 2. Copy Direction

Press **Utility** → **CH Copy** → **Direction** to set the direction of channel copy as "CH1->CH2", "CH2->CH1" or "Swap" (only available when the copy type is set to "State", swap the states of CH1 and CH2).

Then, press **CH1=CH2** at the front panel under any interface to execute the channel copy operation.

#### Note:

Channel coupling and channel copy are mutually exclusive. Channel copy (press **CH1=CH2** at the front panel) is forbidden when channel coupling is enabled.

## User-defined Waveform Key

The **User** key at the front panel of DG4000 provides a shortcut for users. You can define this shortcut key as the desired built-in waveform or waveform stored. You can recall and set the desired waveform under any operation interface once you press this shortcut key.

To modify the waveform recalled by this shortcut key, press **Utility** → **UserKey** to open the user-defined waveform interface. Use the knob to select the desired waveform (such as: AbsSine) from the interface, use  to open the 2/2 menu page and then press **Select**.

Note: to define **User** as the shortcut key of the stored waveform, press **Utility** → **UserKey**, use  to open the 2/2 menu page and press **Stored** to select the desired file. **Stored** is only available when “.RAF” file is currently stored in the instrument.

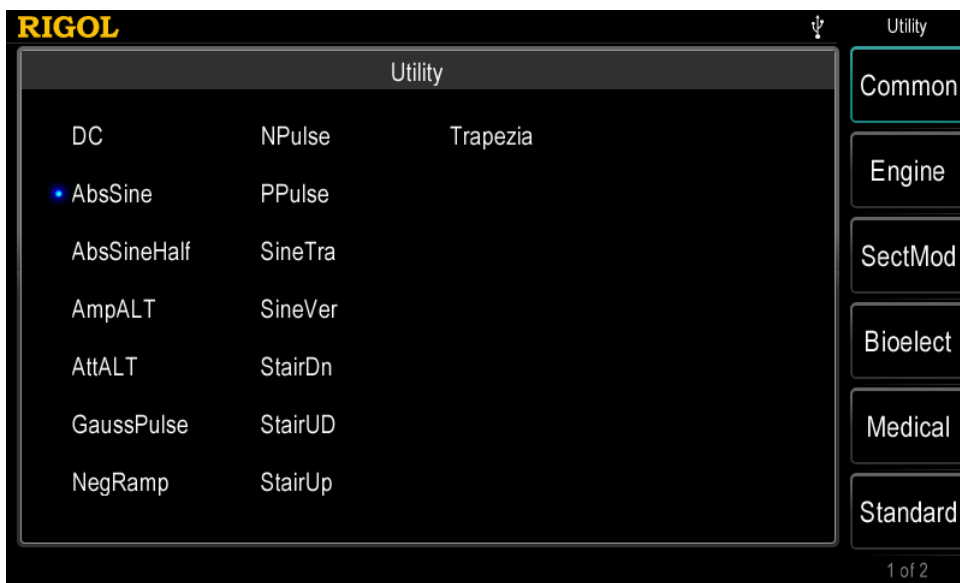

Figure 10-5 User-defined Waveform Interface

At this point, pressing **User** under any interface would output AbsSine signal from the corresponding channel (if currently turned on) and you can also modify the AbsSine signal parameters.



Figure 10-6 Press **User** Key to Quickly Edit Waveform Parameters

## Restore Default

Restore the generator to its default state or user-preset states.

- Default State: the parameter values are as shown in the table below. Note that items marked with "\*" will not be affected by the preset operation.
- User-preset States: correspond to the 10 state files stored in internal memory.

Press **Utility** → **Preset** to select "Default" or one of "User1" to "User10". Press **Preset** at the front panel under any state to switch the instrument to the specified state. Note that before selecting "User1" to "User10", make sure that valid state file is stored in the corresponding storage location.

Table 10-1 Factory Default Values

Parameters	Defaults
<b>Channel Parameters</b>	
Current Carrier Waveform	Sine
Output Resistance	HighZ
Sync Output	On
Sync Polarity	Pos
Output Polarity	Normal
Noise	OFF
Noise Scale	10%
Coupling	Off
Coupling Base	CH1
Phase Deviation	0°
Frequency Deviation	0μHz
Amplitude Deviation	0Vpp
<b>Basic Waveform</b>	
Frequency	1kHz
Amplitude	5Vpp
Amplitude Unit	Vpp
Offset	0V <sub>DC</sub>
Start Phase	0°

Square Duty Cycle	50%
Ramp Waveform Symmetry	50%
Pulse Duty Cycle	50%
Pulse Width	500 $\mu$ s
Pulse Leading Edge	1.9531 $\mu$ s
Pulse Trailing Edge	1.9531 $\mu$ s
<b>Arb Waveform</b>	
Built-in Arbitrary Waveform	Sinc
Point By Point Output	Off
<b>Harmonic</b>	
Order	2
Type	Even
Amplitude	1.264,7Vpp
Phase	0°
<b>AM Modulation</b>	
Modulation Source	Int
Modulating Waveform	Sine
AM Frequency	100Hz
Modulation Depth	100%
<b>FM Modulation</b>	
Modulation Source	Int
Modulating Waveform	Sine
FM Frequency	100Hz
Frequency Deviation	1kHz
<b>PM Modulation</b>	
Modulation Source	Int
Modulating Waveform	Sine
PM Frequency	100Hz
Phase Deviation	90°
<b>PWM Modulation</b>	

Modulation Source	Int
Modulating Waveform	Pulse
Modulating Frequency	100Hz
Width Deviation	200 $\mu$ s
Duty Cycle Deviation	20%
<b>ASK Modulation</b>	
Modulation Source	Int
ASK Rate	100Hz
Modulating Amplitude	2Vpp
ASK Polarity	Pos
<b>FSK Modulation</b>	
Modulation Source	Int
FSK Rate	100Hz
Hop Frequency	10kHz
FSK Polarity	Pos
<b>PSK Modulation</b>	
Modulation Source	Int
PSK Rate	100Hz
PSK Phase	180°
PSK Polarity	Pos
<b>BPSK Modulation</b>	
Rate	100Hz
Phase	180°
Modulating Waveform	Sine
<b>QPSK Modulation</b>	
Rate	100Hz
Phase 1	45°
Phase 2	135°
Phase 3	225°
Modulating Waveform	Sine



<b>3FSK Modulation</b>	
Key Frequency	100Hz
Hop Frequency 1	100Hz
Hop Frequency 2	100Hz
<b>4FSK Modulation</b>	
Key Frequency	100Hz
Hop Frequency 1	100Hz
Hop Frequency 2	100Hz
Hop Frequency 3	100Hz
<b>OSK Modulation</b>	
Modulation Source	Int
Rate	1kHz
Oscillate Time	100 $\mu$ s
<b>Sweep</b>	
Sweep Type	Linear
Step	2
Sweep Time	1s
Start Hold	0s
End Hold	0s
Return Time	0s
Start Frequency	100Hz
End Frequency	1kHz
Center Frequency	550Hz
Frequency Span	900Hz
Mark Frequency	Off
Trigger Source	Int
Trigger Output	Off
Slope Input	Leading
<b>Burst</b>	
Burst Mode	N Cycle
Cycle Number	1
Start Phase	0°

Delay	0s
Gated Polarity	Pos
Trigger Source	Int
Trigger Output	Off
Trigger Input	Leading
Trigger Period	10ms
<b>System Parameter</b>	
DHCP	On
Auto IP	On
Manual IP	Off
Beeper	On
Power On Setting	Default
Screen Saver	On
Clock Source	Internal
Decimal Point	Dot
Thousand Separator	Comma
Brightness*	Factory Delivery Setting
Language*	Factory Delivery Setting
Print Destination	USB Storage Device
Picture Format	Bmp
<b>Counter</b>	
Sensitivity	50%
Trigger Level	0V
Input Resistance	HighZ
Coupling	AC
Attenuation	×1
HF Reject	OFF
Gate Time	1ms
Measurement Item	Frequency
Statistic Function	OFF
Display Format	Digital

# Chapter 11 Remote Control

Users can control DG4000 through remote interfaces. This chapter provides basic information and method of remote control of the instrument.

Subjects in this chapter:

- Remote Control Overview
- Remote Control Mode

## Remote Control Overview

DG4000 can communicate with PC through USB or LAN interface to realize remote control on the basis of SCPI commands (Standard Commands for Programmable Instruments). DG4000 supports SCPI 1999.1.

When the instrument is working in remote mode, the  indicator in the upper right corner of the user interface will light and the keys at the front panel are locked. Now you can return the instrument to local mode by pressing **Burst**.

## Remote Control Mode

Remote control of DG4000 on the basis of SCPI commands mainly contains the following two modes:

1. To control DG4000 by programming
2. To control DG4000 by using PC software

## User-defined Programming

Users can program and control DG4000 by using the SCPI commands on the basis of NI-VISA (National Instrument – Virtual Instrument Software Architecture) library.

### 1. Install NI-VISA Library

You need to install the VISA library of NI (download from <http://www.ni.com/visa/>) on your PC. NI-VISA is an application program interface developed by NI according to the VISA standards. You can use NI-VISA to realize the communication between the generator and PC through instrument buses (such as USB). VISA defines a set of software commands with which users can control the instrument without the need to understand how the interface bus works. For details, please refer to NI-VISA Help.

### 2. Build Communication between Instrument and PC

You need to build the communication between the generator and PC.

- USB Interface: use USB cable to connect the generator and PC. At this point, the hardware update wizard dialog box is displayed. Then, follow the instructions to install the “USB Test and Measurement Device”.

#### Steps:

- 1) Select “Install the software automatically (Recommended)”;
- 2) Click “Next”;

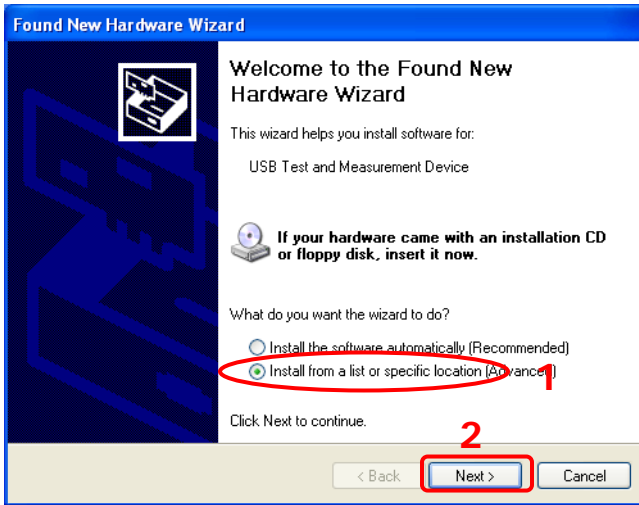

- 3) Select "Don't search. I will choose the driver to install";
- 4) Click "Next";

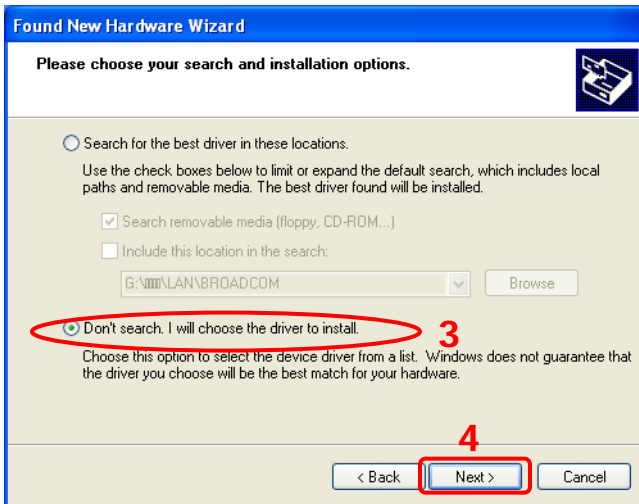

- 5) Select "USB Test and Measurement Device";
- 6) Click "Next";

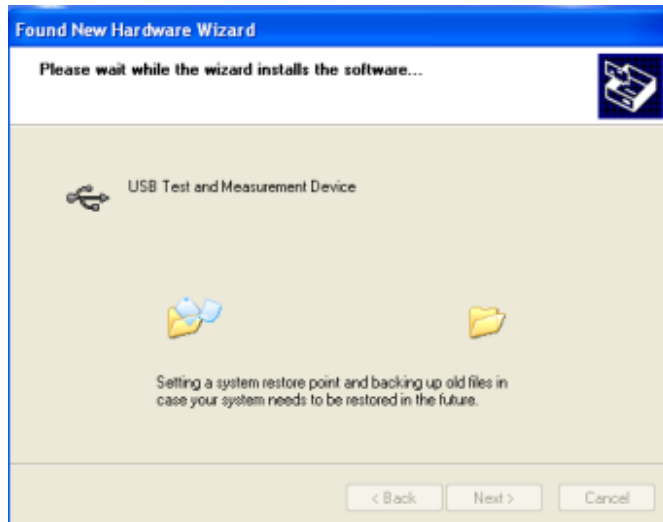
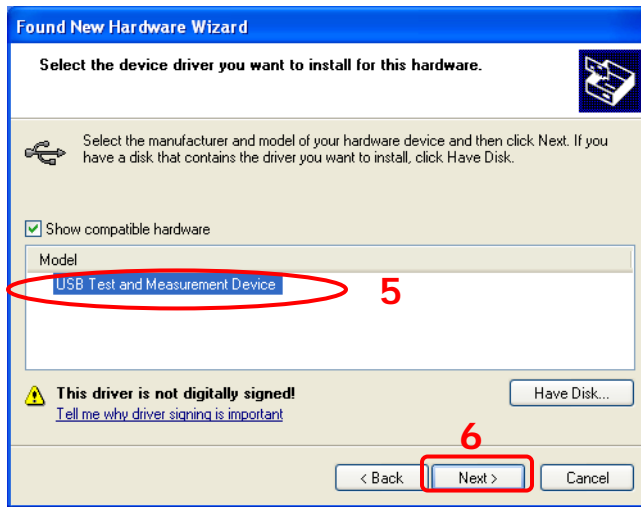

7) When the installation is finished, click "Finish".

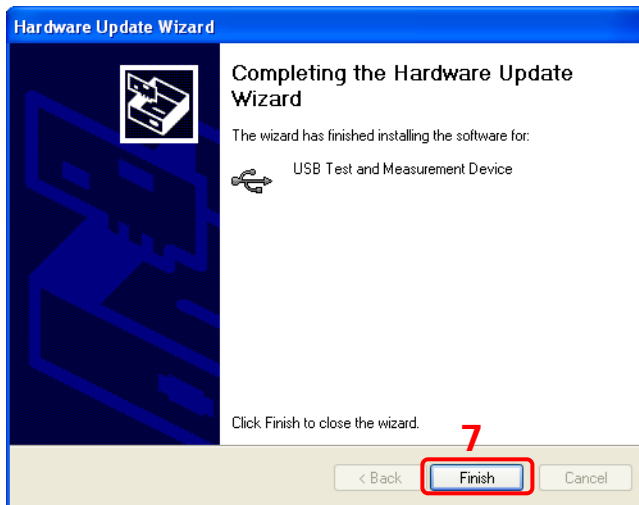

- LAN Interface: connect your generator to the local area network of the PC and set the network parameters correctly following the instructions in **LAN Setting**.

### 3. Programming

Then, you can select a familiar software developing tool for programming. The developing tools available include Visual C++ 6.0, Visual Basic 6.0, LabVIEW 8.6 and etc. For detailed information about SCPI commands and programming method of DG4000, refer to DG4000 Programming Guide.



## To Use PC Software

You can control DG4000 remotely by sending SCPI commands using PC software. PC software supported by DG4000 includes:

- General PC software **Ultra Sigma** of **RIGOL**
- Measurement & Automation Explore of NI (National Instrument Corporation)
- Agilent IO Libraries Suite of Agilent (Agilent Technologies, Inc.)

This section introduces in details how to use **Ultra Sigma** to send commands through USB and LAN interfaces to control DG4000. Please refer to Ultra Sigma Help to install the software and the components required correctly.

### 1. To Control the Instrument through USB

#### 1) Connect the devices

Connect the generator (use the USB Device interface at the rear panel) with your PC using USB cable.

#### 2) Install the USB drive

As the generator is a USB-TMC device, after you connect the generator to the PC and turn both on, the PC will display the hardware update wizard dialog box. Please install the “USB Test and Measurement Device” driver following the directions of the wizard.

#### 3) Search device resource

Start up **Ultra Sigma**, the software starts searching the generator resources currently connected to the PC automatically, or click

 to search manually. The status bar of **Ultra Sigma** at present is as shown in the figure below:



#### 4) View the resource

The resources that have been searched successfully are shown under the “RIGOL Online Resource” catalog and the instrument model and VISA descriptor are also displayed, such as

DG4162 (USB0::0x1AB1::0x04B0::DG41620000::INSTR).

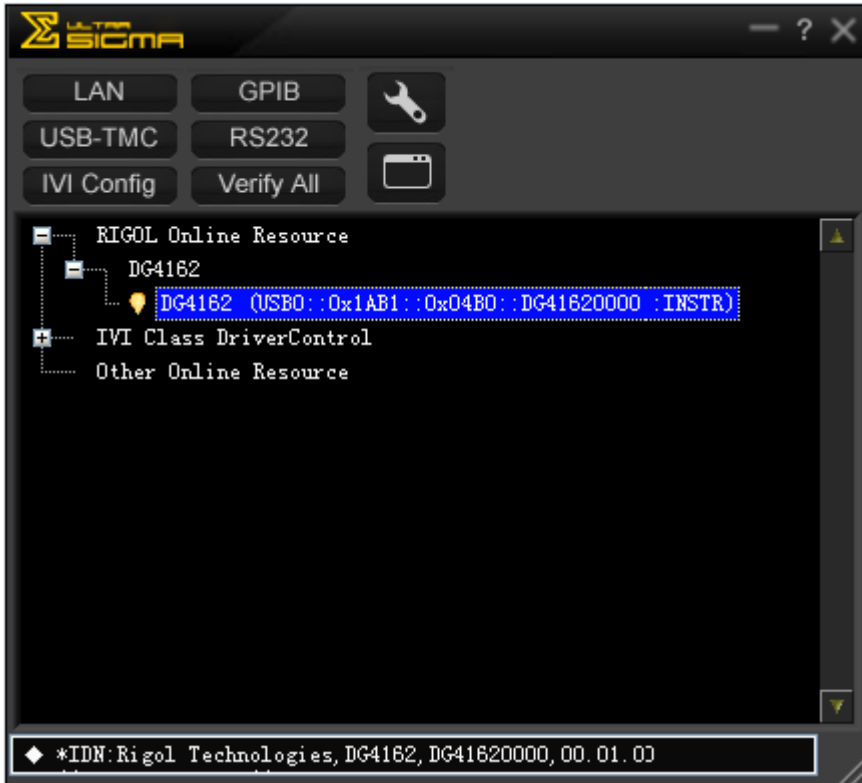

### 5) Communicate Test

Right click the resource name

"DG4162 (USB0::0x1AB1::0x04B0::DG41620000::INSTR)" and select "SCPI Control Panel" to open the remote command control panel through which users can send commands and read data.

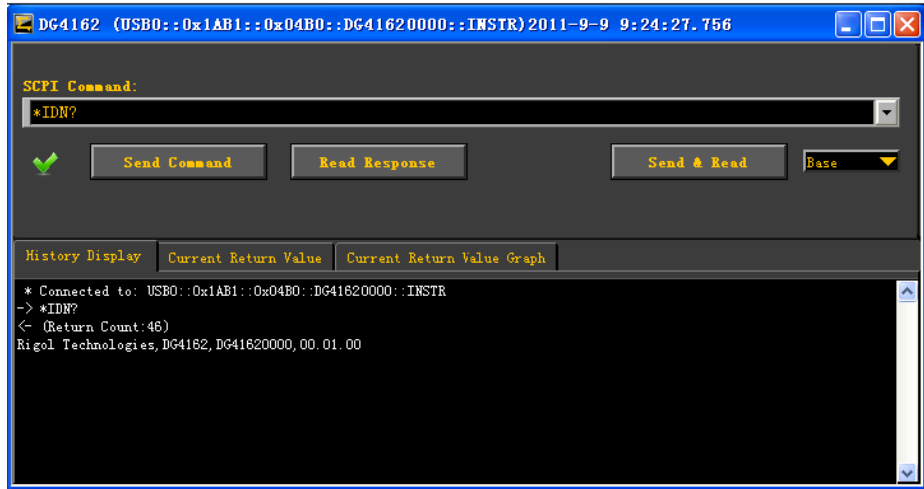

## 2. To Control the Instrument through LAN

### 1) Connect the devices

Connect the generator to your LAN using network cable.

### 2) Configure LAN parameters

Set the LAN parameters of the generator according to the introductions in **To Configure the Remote Interface**.

### 3) Search device resource

Start-up **Ultra Sigma** and click **LAN**, then click **Search** in the pop-up window, the software starts searching the generator resources connected to LAN. Instrument resources searched will be displayed in the right of the window. Select your desired resource and click **OK**, as shown in the following figures.

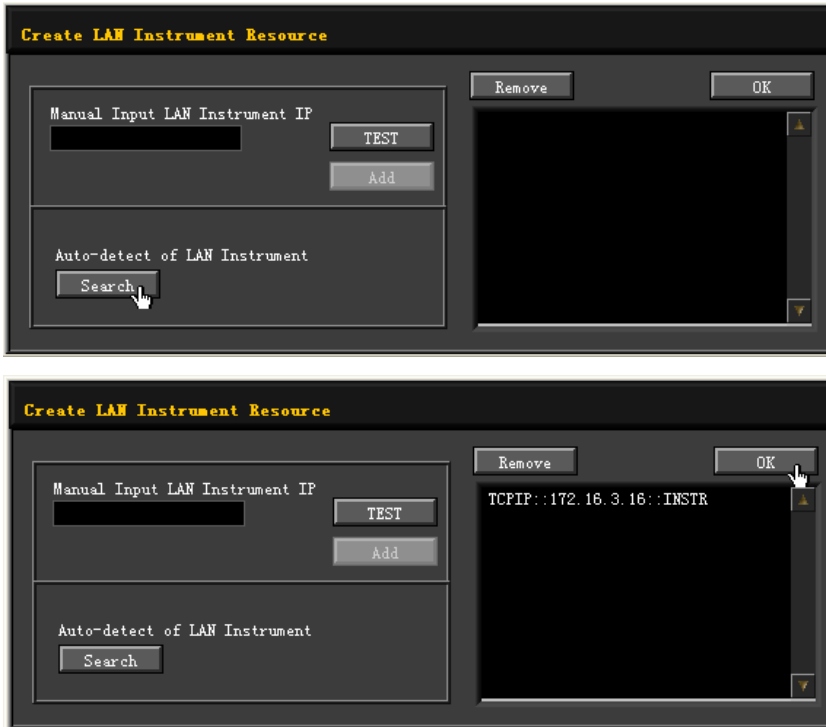

**4) View the resource**

The resources that have been searched successfully are shown under the "RIGOL Online Resource" catalog and the instrument model and VISA descriptor are also displayed, such as DG4162 (TCPIP::172.16.3.16::INSTR).

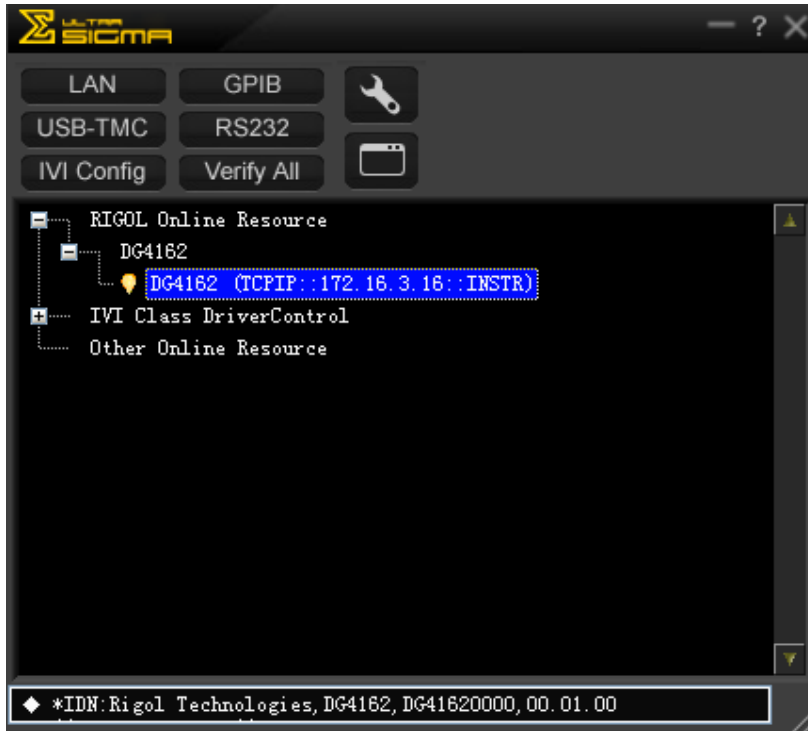

### 5) Communication test

Right click the resource name “DG4162 (TCPIP::172.16.3.16::INSTR)” and select “SCPI Control Panel” to open the remote command control panel through which users can send commands and read data.



### 6) Load LXI webpage

The generator conforms to LXI-C standards. You can load LXI webpage

conveniently through **Ultra Sigma** (right-click the resource name and select “LXI-Web”). On the webpage, some important information about the generator such as the model, manufacturer, serial number, description, MAC address and IP address is shown.

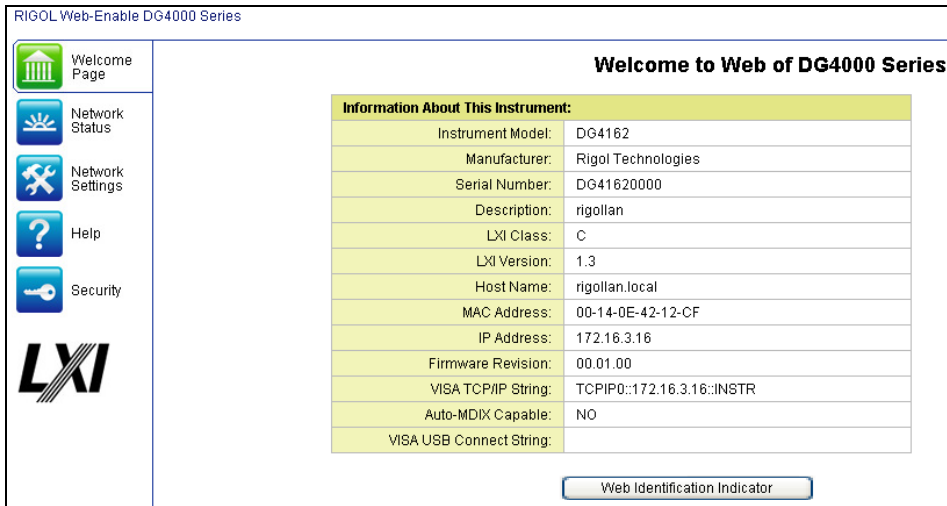

**Tip**

You can also load LXI webpage by input the IP address of the generator in the address bar of the PC browser.

# Chapter 12 Troubleshooting

This chapter lists the commonly encountered failures of DG4000 and their solutions. When you encounter those problems, please solve them following the corresponding steps. If the problem persists, please contact **RIGOL** and provide your device information (**Utility** → **System** → **Sys Info**).

## 1. The screen is still dark (no display) after power on:

- (1) Check if the power is correctly connected.
- (2) Check if the power switch is really on.
- (3) Restart the instrument after finishing the above inspections.
- (4) If it does not work correctly, contact **RIGOL** for our service.

## 2. The settings are correct but no waveform is generated:

- (1) Check if the BNC cable is correctly connected to the channel output terminal (**Output1** or **Output2**).
- (2) Check if the BNC cable can work correctly.
- (3) Check the **Output1** or **Output2** button, if it is turned on.
- (4) Set **PowerOn** as "Last" and then restart the instrument after finishing the above inspections.
- (5) If it does not work correctly, contact **RIGOL** for our service.

## 3. The USB storage device cannot be recognized:

- (1) Check if the USB storage device can work normally.
- (2) Make sure the USB storage device is USB flash storage device. The generator doesn't support hard drive-based USB storage device.
- (3) Restart the instrument, reinsert the U-disk and check it.
- (4) If the USB storage device still can not be recognized, please contact **RIGOL**.





# Chapter 13 Specifications

All the specifications can be guaranteed if the following two conditions are met unless where noted.

- The generator is within the calibration period and has performed self-calibration.
- The generator has been working continuously for at least 30 minutes under the specified temperature (18°C ~ 28°C).

All the specifications are guaranteed unless those marked with "typical".

Model	DG4162	DG4102	DG4062
Channel	2	2	2
Maximum Frequency	160MHz	100MHz	60 MHz
Sample Rate	500MSa/s		
<b>Waveforms</b>			
Standard waveforms	Sine, Square, Ramp, Pulse, Noise, Harmonics		
Arbitrary Waveforms	150 kinds, including Sinc, Exponential Rise, Exponential Fall, ECG, Gauss, HaverSine, Lorentz, Dual-Tone, DC, etc.		
<b>Frequency Characteristics</b>			
Sine	1μHz to 160MHz	1μHz to 100MHz	1μHz to 60MHz
Square	1μHz to 50MHz	1μHz to 40MHz	1μHz to 25MHz
Ramp	1μHz to 4MHz	1μHz to 3MHz	1μHz to 1MHz
Pulse	1μHz to 40MHz	1μHz to 25MHz	1μHz to 15MHz
Harmonic	1μHz to 80MHz	1μHz to 50MHz	1μHz to 30MHz
Noise (-3dB)	120MHz bandwidth	80MHz bandwidth	60MHz bandwidth
Arbitrary Waveform	1μHz to 40MHz	1μHz to 25MHz	1μHz to 15MHz
Resolution	1μHz		
Accuracy	±2ppm, 18°C to 28°C		
<b>Sine Wave Spectrum Purity</b>			
Harmonic Distortion	Typical (0dBm) DC-1MHz: < -60dBc		

	1MHz-10MHz: <-55dBc 10MHz-100MHz: <-50dBc 100MHz-160MHz: <-40dBc		
Total Harmonic Distortion	<0.1% (10Hz-20kHz,0dBm)		
Spurious (non-harmonic)	Typical (0dBm) ≤10MHz <-65dBc >10MHz <-65dBc+6dB/octave		
Phase Noise	Typical (0dBm, 10kHz deviation) 10MHz: ≤-115dBc/Hz		
<b>Signal Characteristics</b>			
<b>Square</b>			
Rise/Fall Time	Typical (1Vpp) <8ns	Typical (1Vpp) <10ns	Typical (1Vpp) <12ns
Overshoot	Typical (100KHz, 1Vpp) <3%		
Duty Cycle	≤10MHz: 20.0% to 80.0% 10MHz-40MHz: 40.0% to 60.0% >40MHz: 50.0% (fixed)		
Non-symmetry	1% of period +5ns		
Jitter (rms)	Typical (1MHz, 1Vpp, 50Ω) ≤5MHz 2ppm+500ps >5MHz 500ps		
<b>Ramp</b>			
Linearity	≤1% of peak output (Typical, 1kHz, 1VPP, 100% Symmetry)		
Symmetry	0% to 100%		
<b>Pulse</b>			
Period	25ns to 1000000s	40ns to 1000000s	66.7ns to 1000000s
Pulse Width	≥10ns	≥12ns	≥18ns
Leading/ Trailing Edge Time	≥5ns	≥7ns	≥11ns
Overshoot	Typical (1Vpp) <3%		
Jitter (rms)	Typical (1Vpp) ≤5MHz 2ppm+500ps		

	>5MHz 500ps		
<b>Arb</b>			
Waveform Length	16k points		
Vertical Resolution	14bits		
Sample Rate	500MSa/s		
Minimum Rise/Fall Time	Typical (1Vpp) <5ns		
Jitter (rms)	Typical (1Vpp) ≤5MHz 2ppm+500ps >5MHz 500ps		
Interpolation Method	Off, Linear		
Edit Method	Edit Points, Edit Block		
<b>Harmonic</b>			
Harmonic Order	≤16		
Harmonic Type	Even, Odd, All, User		
Harmonic Amplitude	can be set for all harmonics		
Harmonic Phase	can be set for all harmonics		
<b>Output Characteristics</b>			
<b>Amplitude (into 50 Ω)</b>			
Range	≤20MHz: 1mVpp to 10Vpp ≤70MHz: 1mVpp to 5Vpp ≤120MHz: 1mVpp to 2.5Vpp ≤160MHz: 1mVpp to 1Vpp	≤20MHz: 1mVpp to 10Vpp ≤70MHz: 1mVpp to 5Vpp ≤100MHz: 1mVpp to 2.5Vpp	≤20MHz: 1mVpp to 10Vpp ≤60MHz: 1mVpp to 5Vpp
Accuracy	Typical (1kHz Sine, 0V Offset, >10mVpp, Auto) ± 1% of setting ± 2mVpp		
Flatness (relative to 1kHz Sine wave, 500mVpp, 50Ω)	Typical ≤10MHz: ±0.1dB ≤60MHz: ±0.2dB ≤100MHz: ±0.4dB ≤160MHz: ±0.8dB	Typical ≤10MHz: ±0.1dB ≤60MHz: ±0.2dB ≤100MHz: ±0.4dB	Typical ≤10MHz: ±0.1dB ≤60MHz: ±0.2dB
Units	Vpp, Vrms, dBm		
Resolution	1mV or 3bits		

<b>Offset (into 50 Ω)</b>	
Range	±5Vpk ac + dc
Accuracy	±(1% of setting + 5mV + 0.5% of amplitude)
<b>Waveform Output</b>	
Impedance	50Ω (Typical)
Protection	Short-circuit protection, automatically disable waveform output when overload occurs
<b>Modulation Characteristics</b>	
Modulation Type	AM, FM, PM, ASK, FSK, PSK, BPSK, QPSK, 3FSK, 4FSK, OSK, PWM
<b>AM</b>	
Carrier Waveform	Sine, Square, Ramp, Arb (except DC)
Source	Internal/External
Modulating Waveform	Sine, Square, Ramp, Noise, Arb
Depth	0% to 120%
Modulating Frequency	2mHz to 50KHz
<b>FM</b>	
Carrier Waveform	Sine, Square, Ramp, Arb (except DC)
Source	Internal/External
Modulating Waveform	Sine, Square, Ramp, Noise, Arb
Modulating Frequency	2mHz to 50KHz
<b>PM</b>	
Carrier Waveform	Sine, Square, Ramp, Arb (except DC)
Source	Internal/External
Modulating Waveform	Sine, Square, Ramp, Noise, Arb
Phase Deviation	0° to 360°
Modulating Frequency	2mHz to 50KHz
<b>ASK</b>	
Carrier Waveform	Sine, Square, Ramp, Arb (except DC)
Source	Internal/External
Modulating Waveform	Square with 50% duty cycle
Key Frequency	2mHz to 1MHz
<b>FSK</b>	
Carrier Waveform	Sine, Square, Ramp, Arb (except DC)
Source	Internal/External
Modulating Waveform	Square with 50% duty cycle

Key Frequency	2mHz to 1MHz
<b>3FSK</b>	
Carrier Waveform	Sine, Square, Ramp, Arb (except DC)
Source	Internal
Modulating Waveform	Square with 50% duty cycle
Key Frequency	2mHz to 1MHz
<b>4FSK</b>	
Carrier Waveform	Sine, Square, Ramp, Arb (except DC)
Source	Internal
Modulating Waveform	Square with 50% duty cycle
Key Frequency	2mHz to 1MHz
<b>PSK</b>	
Carrier Waveform	Sine, Square, Ramp, Arb (except DC)
Source	Internal/External
Modulating Waveform	Square with 50% duty cycle
Key Frequency	2mHz to 1MHz
<b>BPSK</b>	
Carrier Waveform	Sine, Square, Ramp, Arb (except DC)
Source	Internal
Modulating Waveform	Sine, Square, Ramp, Noise, Arb (2mHz to 50kHz)
Key Frequency	2mHz to 1MHz
<b>QPSK</b>	
Carrier Waveform	Sine, Square, Ramp, Arb (except DC)
Source	Internal
Modulating Waveform	Sine, Square, Ramp, Noise, Arb (2mHz to 50kHz)
Key Frequency	2mHz to 1MHz
<b>OSK</b>	
Carrier Waveform	Sine
Source	Internal/External
Oscillation Time	8ns to 499.75 $\mu$ s
Key Frequency	2mHz to 1MHz
<b>PWM</b>	
Carrier Waveform	Pulse
Source	Internal/External
Modulating Waveforms	Sine, Square, Ramp, Noise, Arb
Width Deviation	0% to 100% of Pulse Width

Modulating Frequency	2mHz to 50KHz		
<b>[Mod/FSK/Trig] Input</b>			
Input Range	75mVRMS to $\pm 2.5V_{ac} + dc$		
Input Bandwidth	5MHz		
Input Impedance	100 $\Omega$		
<b>Burst Characteristics</b>			
Carrier Waveform	Sine, Square, Ramp, Pulse, Noise, Arb (except DC)		
Carrier Frequency	2mHz to 100MHz	2mHz to 100MHz	2mHz to 60MHz
Burst Count	1 to 1 000 000 or Infinite		
Start/Stop Phase	0° to 360°		
Internal Period	2 $\mu$ s to 500s		
Gated Source	External Trigger		
Trigger Source	Internal, External or Manual		
Trigger Delay	0ns to 85s		
<b>Sweep Characteristics</b>			
Carrier Waveform	Sine, Square, Ramp, Arb (except DC)		
Type	Linear, Log or Step		
Direction	Up or Down		
Start/Stop Frequency	1 $\mu$ Hz to 160MHz	1 $\mu$ Hz to 100MHz	1 $\mu$ Hz to 60MHz
Sweep Time	1ms to 300s		
Hold/Return Time	0ms to 300s		
Trigger Source	Internal, External or Manual		
Mark	Falling edge of Sync signal (programmable)		
<b>Counter Specifications</b>			
Function	Frequency, Period, Positive/Negative Pulse Width, Duty Cycle		
Frequency Resolution	7 digits/second (Gate Time = 1s)		
Frequency Range	1 $\mu$ Hz to 200MHz		
Period Measurement	Measurement Range	5ns to 16 days	
Voltage Range and Sensitivity (Not modulation signal)			
DC Coupling	DC Offset Range	$\pm 1.5V_{DC}$	
	1 $\mu$ Hz to 100MHz	50mVRMS to $\pm 2.5V_{ac} + dc$	
	100MHz to 200MHz	100mVRMS to $\pm 2.5V_{ac} + dc$	
AC Coupling	1 $\mu$ Hz to 100MHz	50mVRMS to $\pm 2.5V_{pp}$	
	100MHz to 200MHz	100mVRMS to $\pm 2.5V_{pp}$	
			Input Attenuation: "closed"

Pulse Width and Duty Cycle Measurement			
Frequency/Amplitude Range	1 $\mu$ Hz to 25MHz	50mVRMS to $\pm 2.5V_{ac+dc}$	DC Coupling Input Attenuation: "closed"
Pulse Width	Minimum	$\geq 20ns$	
	Resolution	2ns	
Duty Cycle	Range (Display)	0% to 100%	
Input Characteristics			
Input Range	Breakdown Voltage	$\pm 7V_{ac+dc}$ (Attenuation: closed)	Impedance=1M $\Omega$
		$\pm 70V_{ac+dc}$ (Attenuation: open)	
		5Vrms	Impedance=50 $\Omega$
Input Adjustment	Attenuation	Open: "x10"; Closed: "x1"	
	Impedance	50 $\Omega$	1M $\Omega$
	Coupling	AC	DC
	HF Reject	ON: input bandwidth=250KHz; OFF: input bandwidth=225MHz	
Input Trigger	Trigger Level Range	-2.5V to +2.5V	
	Trigger Sensitivity Range	0% (140mV hysteresis voltage) to 100% (2mV hysteresis voltage)	
Gate Time	GateTime1	1ms	
	GateTime2	10ms	
	GateTime3	100ms	
	GateTime4	1s	
	GateTime5	10s	
	GateTime6	>10s	
Trigger Characteristics			
Trigger Input			
Level	TTL-compatible		
Slope	Rising or falling (selectable)		
Pulse Width	> 50ns		

Latency	Sweep: <100ns (typical) Burst: <300ns (typical)
<b>Trigger Output</b>	
Level	TTL-compatible
Pulse Width	> 60ns (typical)
Maximum Rate	1MHz
<b>Clock Reference</b>	
<b>Phase Offset</b>	
Range	0° to 360°
Resolution	0.03°
<b>External Reference Input</b>	
Lock Range	10MHz ± 50Hz
Level	250mVpp to 5Vpp
Lock Time	< 2s
Impedance (Typical)	1kΩ, AC coupling
<b>Internal Reference Output</b>	
Frequency	10MHz ± 50Hz
Level	3.3Vpp
Impedance (Typical)	50Ω, AC coupling
<b>Sync Output</b>	
Level	TTL-compatible
Impedance	50 Ω, nominal value
<b>General Specifications</b>	
<b>Power</b>	
Power Voltage	100V to 240V (45Hz to 440Hz)
Power Consumption	Less than 50W
Fuse	250V, T2A
<b>Display</b>	
Type	7-inch TFT LCD
Resolution	800 Horizontal × RGB × 480 Vertical Resolution
Color	16M color
<b>Environment</b>	
Temperature Range	Operating: 10°C to 40°C



	Non-Operating: -20°C to 60°C
Cooling Method	Cooling by fans compulsively
Humidity Range	Less than 35°C: ≤90% Relative Humidity (RH) 35°C to 40°C: ≤60% Relative Humidity (RH)
Altitude	Operating: Less than 3000 meters Non-Operating: Less than 15000 meters
<b>Mechanical</b>	
Dimensions (W×H×D)	313 mm ×160.7 mm×116.7mm
Weight	without package: 3.2 kg with package: 4.5 kg
<b>Interfaces</b>	
USB Host, USB Device, LAN	
<b>IP Protection</b>	
IP2X	
<b>Calibration Interval</b>	
Recommend 1 year for standard interval	



# Chapter 14 Appendix

## Appendix A: Options and Accessories

	Description	Order Number
<b>Model</b>	DG4162 (160 MHz, dual-channel)	DG4162
	DG4102 (100 MHz, dual-channel)	DG4102
	DG4062 (60 MHz, dual-channel)	DG4062
<b>Standard Accessories</b>	Power Cord	-
	USB Cable	CB-USB
	BNC Cable (1 meter)	CB-BNC-BNC-1
	Quick Guide	-
	Resource CD (including User's Guide and Application Software)	-
	Warranty Card	-
<b>Options</b>	40dB Attenuator	ATT-40dB
	Rack Mount Kit	RMK-DG-4

**NOTE:** All the options or accessories can be ordered from you local **RIGOL** Office.

## Appendix B: Power Amplifier Specifications

Unless otherwise noted, all the specifications can be guaranteed under the following two conditions.

- The instrument has been working continuously for at least 30 minutes under the specified operation temperature.
- All the specifications are guaranteed except those marked with “Typical”.

<b>Signal Input</b>	
Input Impedance	50k $\Omega$
Built-in Bias Voltage (output equivalent)	$\pm 12V$
External Input	$\pm 10V_{max}$ (gain: X1) $\pm 1.25V_{max}$ (gain: X10)
<b>Power Amplifier Specifications</b>	
Running Mode	Constant voltage
Gain	Switch between 10V/1V and 10V/10V (DC gain error <5%)
Polarity Switch	Normal/Invert
Effective Value of Sine Output Power ( $R_L=7.5\Omega$ )	10W (Typical, Sine input, 100kHz, X10)
Output Voltage	12.5V <sub>peak</sub> (Sine input, 100kHz)
Output Current	1.65A <sub>peak</sub> (Sine input, 100kHz)
Output Impedance	<2 $\Omega$
Full Power Bandwidth	DC to 1MHz <sup>[1]</sup>
Output Slew Rate	$\geq 80V/\mu s$ (Typical) <sup>[2]</sup>
Overshoot	<7%
<b>Bias Voltage Specification</b>	
Bias Voltage Gain Error	5% $\pm 100mV$
<b>Others</b>	
Power	DC 12V $\pm 5\%$ , 4A <sub>peak</sub>
Output Protection	Output overcurrent protection, internal temperature abnormality protection

Operating Temperature	0 °C to +35 °C <sup>[3]</sup>
Dimensions (W×H×D)	142.2mm×48.1mm×215.4mm
Net Weight	850g±20g

**Note:**

- [1] Full power bandwidth refers to the maximum frequency when the power amplifier can generate the AC output with the maximum possible amplitude and without distortion.

$$\text{Full power bandwidth } FPB = \frac{SR}{2\pi V_{\max}}$$

SR: Slew Rate (output slew rate)

V<sub>max</sub>: the maximum output amplitude without distortion of the power amplifier

- [2] Definition of Output Slew Rate: input a large step-function signal into the power amplifier and the output slope of the signal would be saturated to a fixed constant at a certain position. This constant is called the Slew Rate of the power amplifier.
- [3] The specifications above are obtained under 25 °C. The range of the environment temperature of PA1011 during operation is from 0 °C to +35 °C. You are recommended to reduce the output power and working power of PA1011 when the environment temperature exceeds 35 °C.

## Appendix C: Warranty

**RIGOL** warrants that the mainframe and accessories of its product will be free from defects in materials and workmanship within the warranty period.

If the product is proven to be defective within the warranty period, **RIGOL** guarantees free replacement or repair of the product. For detailed warranty rules, please refer to the **RIGOL** official website or the instruction in the warranty card. To get repair service or a complete version of the warranty instruction, please contact **RIGOL** maintenance center and local office.

**RIGOL** does not provide any other explicit or implicit warranty items including but not limited to any implicit warranty items about tradability and applicability for special purpose of the product, except the ones being provided by this summary and other applicable warranty cards. **RIGOL** will shoulder no responsibility for indirect, special or consequential damage.

## **Appendix D: Any Comment or Question?**

If you have any comment or question on our document, please mail to:  
service@rigol.com





# Index

- 3FSK ..... 5-25
- 4FSK ..... 5-27
- AC Power Input ..... 1-13
- align phases ..... 2-9
- AM ..... 5-2
- amplitude..... 2-5
- amplitude coupling..... 10-26
- ASK ..... 5-11
- AutoIP ..... 10-13
- BPSK ..... 5-20
- built-in waveform..... 3-4
- Burst ..... 7-2
- Burst delay..... 7-7
- Burst period ..... 7-6
- Burst phase..... 7-6
- Burst Polarity..... 7-6
- Center Frequency ..... 6-3
- Channel Copy ..... 10-29
- clock source ..... 10-20
- counter ..... 8-1
- coupling..... 10-26
- Coupling Base ..... 10-26
- DC offset ..... 2-7
- Default Gateway ..... 10-15
- Delay..... 2-15
- DHCP..... 10-13
- DNS ..... 10-15
- Duty Cycle ..... 2-11
- Duty cycle deviation ..... 5-34
- Edit Block..... 3-11
- Edit Points..... 3-11
- end frequency ..... 6-2
- End Hold..... 6-10
- External Power Amplifier ..... 10-7
- FM ..... 5-5
- Frequency ..... 2-4
- frequency coupling ..... 10-26
- Frequency deviation ..... 5-7
- frequency span ..... 6-3
- Frequency Sweep ..... 6-2
- front panel..... 1-6
- FSK..... 5-14
- Gated Burst ..... 7-4
- harmonic ..... 4-1
- Harmonic Amplitude ..... 4-4
- Harmonic Order ..... 4-3
- harmonic type..... 4-3
- Infinite Burst ..... 7-3
- Leading edge ..... 2-14
- Linear Interpolation ..... 3-11
- Linear Sweep ..... 6-4
- Log Sweep..... 6-5
- MAC Address ..... 10-13
- ManualIP ..... 10-14
- Mark Frequency ..... 6-8
- Modulating Polarity ..... 5-13
- Modulation depth ..... 5-4
- N Cycle ..... 7-2
- Network Status ..... 10-12
- Noise Scale..... 10-6
- Noise Setting ..... 10-6
- noise superposition..... 10-6
- Oscillate period ..... 5-31
- OSK ..... 5-29
- Output Polarity ..... 10-5
- Paste ..... 9-9
- phase coupling ..... 10-26
- Phase deviation..... 5-10

PictBridge .....	10-23	Sweep Time .....	6-7
PM .....	5-8	sweep trigger source .....	6-10
Point By Point Output .....	3-3	Symmetry .....	2-12
Power Key .....	1-6	Sync Output .....	10-3
PSK .....	5-17	Sync Polarity .....	10-4
Pulse Width .....	2-13	Test/Cal .....	10-25
PWM .....	5-32	To Create New Arbitrary Waveform .....	3-10
QPSK .....	5-23	To Edit Arbitrary Waveform .....	3-17
rear panel .....	1-13	To Recall File .....	9-8
remote control .....	11-2	To Save File .....	9-6
Resistance setting .....	10-5	To Set Harmonic Phase .....	4-5
Restore Delay .....	2-15	Trailing edge .....	2-14
Return Time .....	6-8	USB Device .....	1-14
Start Frequency .....	6-2	USB Host .....	1-6
Start Hold .....	6-9	user interface .....	1-17
start phase .....	2-8	User-defined Waveform Key .....	10-30
Step Sweep .....	6-6	VISA Descriptor .....	10-13
Subnet Mask .....	10-15	Volatile Waveform .....	3-9
Supporting Legs .....	1-3	Width deviation .....	5-34